



(Please scan this QR code to view the RHP)



R R KABEL LIMITED

Corporate Identity Number: U28997MH1995PLC085294

REGISTERED OFFICE	CORPORATE OFFICE	CONTACT PERSON	EMAIL AND TELEPHONE	WEBSITE
Ram Ratna House, Victoria Mill Compound, Pandurang Budhkar Marg, Worli, Mumbai 400 013, Maharashtra, India	Alembic Business Park (West), Ground Floor, Bhailal Amin Marg, Gorwa, Vadodara 390 003, Gujarat, India	Himanshu Navinchandra Parmar (Company Secretary and Compliance Officer)	Email: investorrelations.rrkl@rrglobal.com Telephone: +91 22 2494 9009	www.rrkabel.com

THE PROMOTERS OF OUR COMPANY ARE TRIBHUVANPRASAD RAMESHWARLAL KABRA, SHREEGOPAL RAMESHWARLAL KABRA, MAHENDRAKUMAR RAMESHWARLAL KABRA, KIRTIDEVI SHREEGOPAL KABRA, TRIBHUVANPRASAD KABRA HUF, KABRA SHREEGOPAL RAMESHWARLAL HUF AND MAHENDRA KUMAR KABRA HUF

DETAILS OF OFFER TO THE PUBLIC

Type	Fresh Issue Size	Size of the Offer for Sale	Total Offer Size	Eligibility and Reservations
Fresh Issue and Offer for Sale	Up to [●] equity shares of face value of ₹5 each aggregating up to ₹1,800.00 million	Up to 17,236,808 equity shares of face value of ₹5 each aggregating up to ₹[●] million	Up to ₹[●] million	This Offer is being made in terms of Regulation 6(1) of the Securities and Exchange Board of India (Issue of Capital and Disclosure Requirements) Regulations, 2018, as amended (“SEBI ICDR Regulations”). For details in relation to share reservation among QIBs, Non-Institutional Bidders, Retail Individual Bidder and Eligible Employees, see “Offer Structure” beginning on page 433.

DETAILS OF THE SELLING SHAREHOLDERS, OFFER FOR SALE AND THEIR WEIGHTED AVERAGE COST OF ACQUISITION PER EQUITY SHARE

NAME OF THE SELLING SHAREHOLDER	TYPE	NUMBER OF EQUITY SHARES OF FACE VALUE OF ₹5 EACH (“EQUITY SHARES”) OFFERED	WEIGHTED AVERAGE COST OF ACQUISITION PER EQUITY SHARE (IN ₹)#
Mahendrakumar Rameshwarlal Kabra	Promoter Selling Shareholder	Up to 754,417 Equity Shares	5.42
Hemant Mahendrakumar Kabra	Promoter Group Selling Shareholder	Up to 754,417 Equity Shares	7.05
Sumeet Mahendrakumar Kabra	Promoter Group Selling Shareholder	Up to 754,417 Equity Shares	7.68
Kabel Buildcon Solutions Private Limited	Promoter Group Selling Shareholder	Up to 707,200 Equity Shares	1.65
Ram Ratna Wires Limited	Other Selling Shareholder	Up to 1,364,480 Equity Shares	1.62
TPG Asia VII SF Pte. Ltd.	Investor Selling Shareholder	Up to 12,901,877 Equity Shares	270.08

As certified by the Independent Chartered Accountant, by way of their certificate dated September 6, 2023.

RISKS IN RELATION TO THE FIRST OFFER

This being the first public issue of Equity Shares of our Company, there has been no formal market for the Equity Shares. The face value of each Equity Share is ₹5. The Floor Price, Cap Price and Offer Price (determined by our Company and Investor Selling Shareholder in consultation with the Book Running Lead Managers, in accordance with the SEBI ICDR Regulations), and on the basis of the assessment of market demand for the Equity Shares by way of the Book Building Process as stated in “Basis for Offer Price” beginning on page 120 should not be considered to be indicative of the market price of the Equity Shares after the Equity Shares are listed. No assurance can be given regarding an active or sustained trading in the Equity Shares nor regarding the price at which the Equity Shares will be traded after listing.

GENERAL RISK

Investments in equity and equity-related securities involve a degree of risk and Bidders should not invest any funds in the Offer unless they can afford to take the risk of losing their entire investment. Bidders are advised to read the risk factors carefully before taking an investment decision in the Offer. For taking an investment decision, Bidders must rely on their own examination of our Company and the Offer, including the risks involved. The Equity Shares in the Offer have neither been recommended, nor approved by the Securities and Exchange Board of India (“SEBI”), nor does SEBI guarantee the accuracy or adequacy of the contents of this Red Herring Prospectus. Specific attention of the Bidders is invited to “Risk Factors” beginning on page 28.





COMPANY’S AND SELLING SHAREHOLDERS’ ABSOLUTE RESPONSIBILITY

Our Company, having made all reasonable inquiries, accepts responsibility for and confirms that this Red Herring Prospectus contains all information with regard to our Company and the Offer, which is material in the context of the Offer, that the information contained in this Red Herring Prospectus is true and correct in all material aspects and is not misleading in any material respect, that the opinions and intentions expressed herein are honestly held and that there are no other facts, the omission of which makes this Red Herring Prospectus as a whole or any of such information or the expression of any such opinions or intentions misleading in any material respect. Further, each of the Selling Shareholders, severally and not jointly, accepts responsibility for and confirms only the statements specifically made by it in this Red Herring Prospectus solely in relation to itself and its respective portion of the Offered Shares and assumes responsibility that such statements are true and correct in all material respects and not misleading in any material respect. Further, each Selling Shareholder, severally and not jointly, does not assume responsibility for any other statement, including without limitation, any and all statements made by or relating to our Company or its business or any other Selling Shareholder(s) or any other person(s), in this Red Herring Prospectus.

LISTING

The Equity Shares that will be offered through this Red Herring Prospectus are proposed to be listed on the Stock Exchanges being BSE Limited (“BSE”) and National Stock Exchange of India Limited (“NSE”). For the purposes of the Offer, BSE is the Designated Stock Exchange.

BOOK RUNNING LEAD MANAGERS

NAME OF THE BRLM	CONTACT PERSON	EMAIL AND TELEPHONE	NAME OF THE BRLM	CONTACT PERSON	EMAIL AND TELEPHONE
 AXIS CAPITAL Axis Capital Limited	Pratik Pednekar	Tel: +91 22 4325 2183 E-mail: rrkabel.ipo@axiscap.in	 HSBC HSBC Securities and Capital Markets (India) Private Limited	Sumant Sharma/ Vipin Jha	Tel: +91 22 6864 1289 E-mail: rrkabelipo@hsbc.co.in
 Citi Citigroup Global Markets India Private Limited	Vedika Chitnis	Tel: +91 22 6175 9999 E-mail: rrkabel.ipo@citi.com	 JM FINANCIAL JM Financial Limited	Prachee Dhuri	Tel: +91 22 6630 3030 E-mail: rrkabel.ipo@jmfl.com

REGISTRAR TO THE OFFER

Link Intime India Private Limited	Contact Person: Shanti Gopalkrishnan	Tel: +91 22 4918 6000 Email: rrkabel.ipo@linkintime.co.in
--	---	--

BID/OFFER PERIOD

ANCHOR INVESTOR BID/OFFER PERIOD*	TUESDAY, SEPTEMBER 12, 2023	BID/OFFER OPENS ON	WEDNESDAY, SEPTEMBER 13, 2023	BID/OFFER CLOSES ON#	FRIDAY, SEPTEMBER 15, 2023
--	------------------------------------	---------------------------	--------------------------------------	-----------------------------	-----------------------------------

* Our Company and the Investor Selling Shareholder may, in consultation with the Book Running Lead Managers, consider participation by Anchor Investors in accordance with the SEBI ICDR Regulations.

The UPI mandate end time and date shall be at 5:00 p.m. on the Bid/ Offer Closing Date.



R R KABEL LIMITED

Our Company was originally incorporated as 'Ram Ratna Agro-Plast Limited' at Mumbai, Maharashtra as a public limited company under the Companies Act, 1956, pursuant to the certificate of incorporation dated February 6, 1995, issued by RoC and commenced operations pursuant to a certificate of commencement of business dated June 29, 1995. Subsequently, the name of our Company was changed to 'R R Kabel Limited' and a fresh certificate of incorporation dated November 8, 2000 was issued by the RoC. For details in relation to the changes in the name and registered office of our Company, see "History and Certain Corporate Matters" beginning on page 235.

Registered Office: Ram Ratna House, Victoria Mill Compound, Pandurang Budhkar Marg, Worli, Mumbai 400 013, Maharashtra, India

Corporate Office: Alembic Business Park (West), Ground Floor, Bhailal Amin Marg, Gorwa, Vadodra 390 003, Gujarat, India

Contact Person: Himanshu Navinchandra Parmar, Company Secretary and Compliance Officer

E-mail: investorrelations.rrkl@rrglobal.com; **Website:** www.rrkabel.com; **Telephone:** +91 22 24949009; **Corporate Identity Number:** U28997MH1995PLC085294

THE PROMOTERS OF OUR COMPANY ARE TRIBHUVANPRASAD RAMESHWARLAL KABRA, SHREEGOPAL RAMESHWARLAL KABRA, MAHENDRAKUMAR RAMESHWARLAL KABRA, KIRTI DEVI SHREEGOPAL KABRA, TRIBHUVANPRASAD KABRA HUF, KABRA SHREEGOPAL RAMESHWARLAL HUF AND MAHENDRA KUMAR KABRA HUF

INITIAL PUBLIC OFFER OF UP TO [●] EQUITY SHARES OF FACE VALUE OF ₹5 EACH ("EQUITY SHARES") OF R R KABEL LIMITED ("COMPANY") FOR CASH AT A PRICE OF ₹[●] PER EQUITY SHARE (INCLUDING A PREMIUM OF ₹[●] PER EQUITY SHARE) ("OFFER PRICE") AGGREGATING UP TO ₹[●] MILLION (THE "OFFER") COMPRISING A FRESH ISSUE OF UP TO [●] EQUITY SHARES AGGREGATING UP TO ₹1,800.00 MILLION BY OUR COMPANY ("FRESH ISSUE") AND AN OFFER FOR SALE OF UP TO 754,417 EQUITY SHARES AGGREGATING UP TO ₹[●] MILLION BY MAHENDRAKUMAR RAMESHWARLAL KABRA, UP TO 754,417 EQUITY SHARES AGGREGATING UP TO ₹[●] MILLION BY HEMANT MAHENDRAKUMAR KABRA, UP TO 754,417 EQUITY SHARES AGGREGATING UP TO ₹[●] MILLION BY SUMEET MAHENDRAKUMAR KABRA, UP TO 707,200 EQUITY SHARES AGGREGATING UP TO ₹[●] MILLION BY KABEL BUILDCON SOLUTIONS PRIVATE LIMITED, UP TO 1,364,480 EQUITY SHARES AGGREGATING UP TO ₹[●] MILLION BY RAM RATNA WIRES LIMITED AND UP TO 12,901,877 EQUITY SHARES AGGREGATING UP TO ₹[●] MILLION BY TPG ASIA VII SF PTE. LTD. (COLLECTIVELY THE "SELLING SHAREHOLDERS") (SUCH EQUITY SHARES OFFERED BY THE SELLING SHAREHOLDERS, THE "OFFERED SHARES"). THE OFFER INCLUDES A RESERVATION OF UP TO [●] EQUITY SHARES, AGGREGATING UP TO ₹108.00 MILLION (CONSTITUTING UP TO [●] OF THE POST-OFFER PAID-UP EQUITY SHARE CAPITAL), FOR SUBSCRIPTION BY ELIGIBLE EMPLOYEES ("EMPLOYEE RESERVATION PORTION"). OUR COMPANY AND INVESTOR SELLING SHAREHOLDER, IN CONSULTATION WITH THE BOOK RUNNING LEAD MANAGERS, MAY OFFER A DISCOUNT OF UP TO [●] (EQUIVALENT OF ₹[●] PER EQUITY SHARE) TO THE OFFER PRICE TO ELIGIBLE EMPLOYEES BIDDING UNDER THE EMPLOYEE RESERVATION PORTION ("EMPLOYEE DISCOUNT"). THE OFFER AND NET OFFER SHALL CONSTITUTE [●] AND [●] OF THE POST-OFFER PAID-UP EQUITY SHARE CAPITAL OF OUR COMPANY, RESPECTIVELY.

THE FACE VALUE OF EQUITY SHARES IS ₹5 EACH. THE OFFER PRICE IS [●] TIMES THE FACE VALUE OF THE EQUITY SHARES. THE PRICE BAND AND THE MINIMUM BID LOT WILL BE DECIDED BY OUR COMPANY AND THE INVESTOR SELLING SHAREHOLDER IN CONSULTATION WITH THE BOOK RUNNING LEAD MANAGERS, AND WILL BE ADVERTISED IN ALL EDITIONS OF ENGLISH NATIONAL DAILY NEWSPAPER, THE FINANCIAL EXPRESS, ALL EDITIONS OF HINDI NATIONAL DAILY NEWSPAPER, JANSATTA, AND THE MUMBAI EDITION OF THE MARATHI DAILY NEWSPAPER, NAVSHAKTI, (MARATHI BEING THE REGIONAL LANGUAGE OF MAHARASHTRA, WHERE OUR REGISTERED OFFICE IS LOCATED) EACH WITH WIDE CIRCULATION, AT LEAST TWO WORKING DAYS PRIOR TO THE BID/OFFER OPENING DATE AND SHALL BE MADE AVAILABLE TO BSE LIMITED ("BSE") AND NATIONAL STOCK EXCHANGE OF INDIA LIMITED ("NSE"), AND TOGETHER WITH BSE, THE "STOCK EXCHANGES") FOR THE PURPOSE OF UPLOADING ON THEIR RESPECTIVE WEBSITES IN ACCORDANCE WITH THE SECURITIES AND EXCHANGE BOARD OF INDIA (ISSUE OF CAPITAL AND DISCLOSURE REQUIREMENTS) REGULATIONS, 2018, AS AMENDED (THE "SEBI ICDR REGULATIONS").

In case of any revision to the Price Band, the Bid/Offer Period will be extended by at least three additional Working Days following such revision of the Price Band, subject to the Bid/Offer Period not exceeding 10 Working Days. In cases of force majeure, banking strike or similar circumstances, our Company and the Investor Selling Shareholder may, in consultation with the Book Running Lead Managers, for reasons to be recorded in writing, extend the Bid/Offer Period for a minimum of three Working Days, subject to the Bid/Offer Period not exceeding 10 Working Days. Any revision in the Price Band and the revised Bid/Offer Period, if applicable, will be widely disseminated by notification to the Stock Exchanges, by issuing a public notice, and also by indicating the change on the respective websites of the Book Running Lead Managers and at the terminals of the Syndicate Members and by intimation to Self-Certified Syndicate Banks ("SCSBs"), other Designated Intermediaries and the Sponsor Banks, as applicable.

This Offer is being made in terms of Rule 19(2)(b) of the Securities Contracts (Regulation) Rules, 1957, as amended ("SCRR") read with Regulation 31 of the SEBI ICDR Regulations. The Offer is being made in accordance with Regulation 6(1) of the SEBI ICDR Regulations and through the Book Building Process wherein not more than 50% of the Net Offer shall be available for allocation on a proportionate basis to Qualified Institutional Buyers ("QIBs", and such portion, the "QIB Portion"). Our Company and the Investor Selling Shareholder may, in consultation with the Book Running Lead Managers, allocate up to 60% of the QIB Portion to Anchor Investors on a discretionary basis in accordance with the SEBI ICDR Regulations ("Anchor Investor Portion"), out of which at least one-third shall be available for allocation to domestic Mutual Funds only, subject to valid Bids being received from the domestic Mutual Funds at or above the Anchor Investor Allocation Price. In the event of under-subscription, or non-allocation in the Anchor Investor Portion, the balance Equity Shares shall be added to the Net QIB Portion. Further, 5% of the Net QIB Portion shall be available for allocation on a proportionate basis to Mutual Funds only, and the remainder of the Net QIB Portion shall be available for allocation on a proportionate basis to all QIB Bidders other than Anchor Investors, including Mutual Funds, subject to valid Bids being received at or above the Offer Price. Further, not less than 15% of the Net Offer shall be available for allocation to Non-Institutional Bidders such that: (a) one-third of the portion available to Non-Institutional Investors shall be reserved for applicants with an application size of more than ₹0.20 million and up to ₹1.00 million, and (b) two-thirds of the portion available to Non-Institutional Investors shall be reserved for applicants with an application size of more than ₹1.00 million, provided that the unsubscribed portion in either of such sub-categories may be allocated to applicants in the other sub-category of Non-Institutional Investors, subject to valid Bids being received at or above the Offer Price. Further, not less than 35% of the Net Offer shall be available for allocation to Retail Individual Bidders ("RIBs") in accordance with SEBI ICDR Regulations, subject to valid Bids being received at or above the Offer Price. Further, Equity Shares will be allocated on a proportionate basis to Eligible Employees applying under the Employee Reservation Portion, subject to valid Bids being received from them at or above the Offer Price. All Bidders, other than Anchor Investors, are required to mandatorily utilise the Application Supported by Blocked Amount ("ASBA") process by providing details of their respective bank account (including UPI ID (as defined hereinafter) in case of UPI Bidders) which will be blocked by the SCSBs or the Sponsor Banks as applicable, to participate in the Offer. Anchor Investors are not permitted to participate in the Anchor Investor Portion through the ASBA process. For details, see "Offer Procedure" beginning on page 436.

RISKS IN RELATION TO THE FIRST OFFER

This being the first public issue of Equity Shares of our Company, there has been no formal market for the Equity Shares. The face value of each Equity Share is ₹5. The Floor Price, Cap Price and Offer Price (determined by our Company and the Investor Selling Shareholder, in consultation with the Book Running Lead Managers, in accordance with the SEBI ICDR Regulations), and on the basis of the assessment of market demand for the Equity Shares by way of the Book Building Process as stated in "Basis for Offer Price" beginning on page 120 should not be considered to be indicative of the market price of the Equity Shares after the Equity Shares are listed. No assurance can be given regarding an active or sustained trading in the Equity Shares or regarding the price at which the Equity Shares will be traded after listing.

GENERAL RISK

Investments in equity and equity-related securities involve a degree of risk and Bidders should not invest any funds in the Offer unless they can afford to take the risk of losing their investment. Bidders are advised to read the risk factors carefully before taking an investment decision in the Offer. For taking an investment decision, Bidders must rely on their own examination of our Company and the Offer, including the risks involved. The Equity Shares in the Offer have neither been recommended, nor approved by the Securities and Exchange Board of India ("SEBI"), nor does SEBI guarantee the accuracy or adequacy of the contents of this Red Herring Prospectus. Specific attention of the Bidders is invited to "Risk Factors" beginning on page 28.

COMPANY'S AND SELLING SHAREHOLDERS' ABSOLUTE RESPONSIBILITY

Our Company, having made all reasonable inquiries, accepts responsibility for and confirms that this Red Herring Prospectus contains all information with regard to our Company and the Offer, which is material in the context of the Offer, that the information contained in this Red Herring Prospectus is true and correct in all material aspects and is not misleading in any material respect, that the opinions and intentions expressed herein are honestly held and that there are no other facts, the omission of which makes this Red Herring Prospectus as a whole or any of such information or the expression of any such opinions or intentions misleading in any material respect. Further, each of the Selling Shareholders, severally and not jointly, accepts responsibility for and confirms only the statements specifically made by it in this Red Herring Prospectus solely in relation to itself and its respective portion of the Offered Shares and assumes responsibility that such statements are true and correct in all material respects and not misleading in any material respect. Further, each Selling Shareholder, severally and not jointly, does not assume responsibility for any other statements, including without limitation, any and all statements made by or relating to our Company or its business or any other Selling Shareholder(s) or any other person(s), in this Red Herring Prospectus.

LISTING

The Equity Shares that will be offered through this Red Herring Prospectus are proposed to be listed on the Stock Exchanges. Our Company has received 'in-principle' approvals from BSE and NSE for the listing of the Equity Shares pursuant to letters dated June 9, 2023, each. For the purposes of the Offer, BSE is the Designated Stock Exchange. A copy of this Red Herring Prospectus and the Prospectus shall be filed with the RoC in accordance with Section 26(4) and Section 32 of the Companies Act, 2013. For details of the material contracts and documents available for inspection from the date of this Red Herring Prospectus up to the Bid/Offer Closing Date, see "Material Contracts and Documents for Inspection" beginning on page 463.

BOOK RUNNING LEAD MANAGERS

REGISTRAR TO THE OFFER

<p>Axis Capital Limited 1st Floor, Axis House C-2 Wadia International Centre Pandurang Budhkar Marg Worli, Mumbai 400 025 Maharashtra, India Tel: +91 22 4325 2183 E-mail: rrkabel.ipo@axiscap.in Website: www.axiscapital.co.in Investor grievance ID: complaints@axiscap.in Contact person: Pratik Pednekar SEBI registration number: INM000012029</p>	<p>Citigroup Global Markets India Private Limited 1202, 12th Floor, First International Financial Centre, G Block Bandra Kurla Complex, Bandra (East) Mumbai 400 098 Maharashtra, India Tel: +91 22 6175 9999 E-mail: rrkabel.ipo@citi.com Website: www.online.citibank.co.in/rhtm/citigroupglobalscreen1.htm Investor grievance ID: investors.cgmb@citi.com Contact person: Vedika Chitnis SEBI registration number: INM000010718</p>	<p>HSBC Securities and Capital Markets (India) Private Limited 52/60, Mahatma Gandhi Road Fort, Mumbai 400 001 Maharashtra, India Tel: +91 22 6864 1289 E-mail: rrkabel.ipo@hsbc.co.in Website: https://www.business.hsbc.co.in/en-gb/regulations/hsbc-securities-and-capital-market Investor grievance ID: investorgrievance@hsbc.co.in Contact person: Sumant Sharma/ Vipin Jha SEBI registration number: INM000010353</p>	<p>JM Financial Limited 7th Floor, Energy Appasaheb Marathe Marg Prabhadevi, Mumbai 400 025 Maharashtra, India Tel: +91 22 6630 3030 E-mail: rrkabel.ipo@jmfl.com Website: www.jmfl.com Investor grievance ID: grievance.ibd@jmfl.com Contact person: Prachee Dhuri SEBI registration number: INM000010336</p>	<p>Link Intime India Private Limited C 101, 1st Floor, 247 Park L.B.S Marg Vikhroli (West), Mumbai 400 083 Maharashtra, India Tel: +91-022-810 811 4949 E-mail: rkabel.ipo@linkintime.co.in Website: www.linkintime.co.in Investor grievance ID: rrkabel.ipo@linkintime.co.in Contact person: Shanti Gopalkrishnan SEBI registration number: INR000004058</p>

BID/OFFER OPENS ON*

WEDNESDAY, SEPTEMBER 13, 2023

BID/OFFER CLOSES ON*

FRIDAY, SEPTEMBER 15, 2023

* Our Company and the Investor Selling Shareholder may, in consultation with the Book Running Lead Managers, consider participation by Anchor Investors in accordance with the SEBI ICDR Regulations. The Anchor Investor Bid/Offer Period shall be one Working Day prior to the Bid/Offer Opening Date i.e. Tuesday, September 12, 2023.

The UPI mandate end time and date shall be at 5:00 p.m. on the Bid/ Offer Closing Date.

(This page is intentionally left blank)

TABLE OF CONTENTS

SECTION I: GENERAL	1
DEFINITIONS AND ABBREVIATIONS	1
SUMMARY OF THE OFFER DOCUMENT	15
CERTAIN CONVENTIONS, PRESENTATION OF FINANCIAL, INDUSTRY AND MARKET DATA	24
FORWARD-LOOKING STATEMENTS	27
SECTION II: RISK FACTORS	28
SECTION III: INTRODUCTION	66
THE OFFER	66
SUMMARY OF RESTATED CONSOLIDATED FINANCIAL INFORMATION	68
GENERAL INFORMATION	73
CAPITAL STRUCTURE	81
OBJECTS OF THE OFFER	113
BASIS FOR OFFER PRICE	120
STATEMENT OF SPECIAL TAX BENEFITS	131
CERTAIN U.S. FEDERAL INCOME TAX CONSIDERATIONS	136
SECTION IV: ABOUT OUR COMPANY	139
INDUSTRY OVERVIEW	139
OUR BUSINESS	190
KEY REGULATIONS AND POLICIES	229
HISTORY AND CERTAIN CORPORATE MATTERS	235
OUR MANAGEMENT	243
OUR PROMOTERS AND PROMOTER GROUP	259
OUR GROUP COMPANIES	265
DIVIDEND POLICY	268
SECTION V: FINANCIAL INFORMATION	269
RESTATED CONSOLIDATED FINANCIAL INFORMATION	269
OTHER FINANCIAL INFORMATION	372
CAPITALISATION STATEMENT	376
FINANCIAL INDEBTEDNESS	377
MANAGEMENT'S DISCUSSION AND ANALYSIS OF FINANCIAL CONDITION AND RESULTS OF OPERATIONS	379
SECTION VI: LEGAL AND OTHER INFORMATION	402
OUTSTANDING LITIGATION AND MATERIAL DEVELOPMENTS	402
GOVERNMENT AND OTHER APPROVALS	407
OTHER REGULATORY AND STATUTORY DISCLOSURES	409
SECTION VII: OFFER INFORMATION	427
TERMS OF THE OFFER	427
OFFER STRUCTURE	433
OFFER PROCEDURE	436
RESTRICTIONS ON FOREIGN OWNERSHIP OF INDIAN SECURITIES	453
SECTION VIII: MAIN PROVISIONS OF ARTICLES OF ASSOCIATION	454
SECTION IX: OTHER INFORMATION	463
MATERIAL CONTRACTS AND DOCUMENTS FOR INSPECTION	463
DECLARATION	466

SECTION I: GENERAL

DEFINITIONS AND ABBREVIATIONS

This Red Herring Prospectus uses certain definitions and abbreviations which, unless the context otherwise indicates or implies, or unless otherwise specified, shall have the meaning as provided below. References to any legislations, acts, regulations, rules, directions, guidelines, circulars, notifications, clarifications or policies shall be to such legislations, acts, regulations, rules, guidelines or policies as amended, updated, supplemented, re-enacted or modified, from time to time, and any reference to a statutory provision shall include any subordinate legislation made, from time to time, under such provision.

The words and expressions used in this Red Herring Prospectus, but not defined herein shall have the meaning ascribed to such terms under the SEBI ICDR Regulations, SEBI Listing Regulations, the Companies Act, the SCRA, and the Depositories Act or the rules and regulations made thereunder. Further, the Offer related terms used but not defined in this Red Herring Prospectus shall have the meaning ascribed to such terms under the General Information Document. In case of any inconsistency between the definitions given below and the definitions contained in the General Information Document (as defined below), the definitions given below shall prevail.

The terms not defined herein but used in “Basis for Offer Price”, “Statement of Special Tax Benefits”, “Industry Overview”, “Key Regulations and Policies”, “History and Certain Corporate Matters”, “Our Group Companies”, “Restated Consolidated Financial Information”, “Outstanding Litigation and Material Developments”, “Offer Procedure” and “Main Provisions of Articles of Association” beginning on pages 120, 131, 139, 229, 235, 265, 269, 402, 436 and 454, respectively, shall have the meanings ascribed to such terms in these respective sections.

General Terms

Term	Description
“our Company” or “the Issuer” or “the Company”	R R Kabel Limited, a public limited company incorporated under the Companies Act, 1956, having its Registered Office at Ram Ratna House, Victoria Mill Compound, Pandurang Budhkar Marg, Worli, Mumbai 400 013, Maharashtra, India and its Corporate Office at Alembic Business Park (West), Ground Floor, Bhailal Amin Marg, Gorwa, Vadodara 390 003, Gujarat, India
“we” or “us” or “our”	Unless the context otherwise indicates or implies, our Company together with our Joint Venture, on a consolidated basis as on the date of this Red Herring Prospectus

Company Related Terms

Term	Description
“Articles of Association” or “AoA” or “Articles”	Articles of association of our Company, as amended
Audit Committee	Audit committee of our Board, as described in “ <i>Our Management – Committees of the Board</i> ” on page 249
“Board” or “Board of Directors”	Board of Directors of our Company
“CCPS” or “Preference Shares”	Compulsorily convertible preference shares of face value of ₹1,080.33 of our Company
“Chief Executive Officer” or “CEO”	Chief executive officer of our Company, namely, Dinesh Aggarwal
“Chief Financial Officer” or “CFO”	Chief financial officer of our Company, namely, Rajesh Babu Jain
Committee(s)	Duly constituted committee(s) of our Board of Directors
Company Secretary and Compliance Officer	Company secretary and compliance officer of our Company, namely, Himanshu Navinchandra Parmar
Corporate Office	Alembic Business Park (West), Ground Floor, Bhailal Amin Marg, Gorwa, Vadodara 390 003, Gujarat, India
Corporate Social Responsibility Committee	Corporate social responsibility committee of our Board, as described in “ <i>Our Management – Committees of the Board</i> ” on page 249
Director(s)	Director(s) on the Board
Equity Shares	The equity shares of our Company bearing face value of ₹5 each
ESOP 2020	R R Kabel Employee Stock Option Plan 2020, as described in “ <i>Capital Structure – Employee Stock Option Schemes of our Company</i> ” on page 106
ESOP 2023	R R Kabel Employee Stock Option Plan 2023, as described in “ <i>Capital Structure – Employee Stock Option Schemes of our Company</i> ” on page 106
ESOP Schemes	Collectively, ESOP 2020 and ESOP 2023
Executive Chairman	Executive chairman of our Board, namely, Tribhuvanprasad Rameshwarlal Kabra
Executive Director(s)	Executive directors of our Company. For details, see “ <i>Our Management</i> ” beginning on page 243
GEFL	Global Electrical Factory (India) Limited

Term	Description
Group Companies	The group companies of our Company in accordance with the SEBI ICDR Regulations. For details, see “ <i>Our Group Companies</i> ” beginning on page 265
Independent Chartered Accountant	Bhagwagar Dalal and Doshi, Chartered Accountants
Independent Chartered Engineer	Vishvakarma Consultancy Services Private Limited
Independent Director(s)	Independent director(s) on our Board. For details of the Independent Directors, see “ <i>Our Management</i> ” beginning on page 243
IPO Committee	The IPO committee of our Board
Joint Managing Director	Joint managing director of our Company, namely, Mahendrakumar Rameshwarlal Kabra
“Joint Venture” or “R R Imperial”	R R Imperial Electricals Limited
“Key Managerial Personnel” or “KMP”	Key managerial personnel of our Company in terms of Regulation 2(1)(bb) of the SEBI ICDR Regulations and Section 2(51) of the Companies Act, as described in “ <i>Our Management – Key Managerial Personnel</i> ” on page 256
Managing Director	Managing director of our Company, namely, Shreegopal Rameshwarlal Kabra
“Memorandum of Association” or “MoA”	Memorandum of association of our Company, as amended
Nomination and Remuneration Committee	Nomination, remuneration and compensation committee of our Board, as described in “ <i>Our Management – Committees of the Board</i> ” on page 249
Non-Executive Nominee Director	The non-executive nominee director of the Investor Selling Shareholder on the Board of our Company, namely, Mitesh Daga
Promoters	Promoters of our Company, being, Tribhuvanprasad Rameshwarlal Kabra, Shreegopal Rameshwarlal Kabra, Mahendrakumar Rameshwarlal Kabra, Kirtidevi Shreegopal Kabra, Tribhuvanprasad Kabra HUF, Kabra Shreegopal Rameshwarlal HUF and Mahendra Kumar Kabra HUF
Promoter Group	The individuals and the entities constituting the promoter group of our Company in terms of Regulation 2(1)(pp) of the SEBI ICDR Regulations, as described in “ <i>Our Promoter and Promoter Group</i> ” beginning on page 259
Registered Office	Ram Ratna House, Victoria Mill Compound, Pandurang Budhkar Marg, Worli, Mumbai 400 013, Maharashtra, India
“Registrar of Companies” or “RoC”	Registrar of Companies, Maharashtra at Mumbai
Restated Consolidated Financial Information	The restated consolidated financial information of our Company, comprising of the restated consolidated statement of assets and liabilities as at and for the three month periods ended June 30, 2023 and June 30, 2022 and for the financial years ended March 31, 2023, March 31, 2022 and March 31, 2021, the restated consolidated statement of profit and loss (including other comprehensive income), the restated consolidated statement of changes in equity and the restated consolidated statement of cash flows for the three month periods ended June 30, 2023 and June 30, 2022 and financial years ended March 31, 2023, March 31, 2022 and March 31, 2021, the summary statement of material accounting policies, and other explanatory information prepared in terms of the requirements of Section 26 of Part I of Chapter III of the Companies Act, SEBI ICDR Regulations and the Guidance Note on “Reports in Company Prospectuses (Revised 2019)” issued by ICAI, as amended from time to time
Risk Management Committee	Risk management committee of our Board, as described in “ <i>Our Management – Committees of the Board</i> ” on page 249
RRPL	RSquare Realty Private Limited
“Senior Management” or “Senior Management Personnel”	Senior management personnel of our Company in terms of Regulation 2(1)(bbbb) of the SEBI ICDR Regulations as described in “ <i>Our Management – Senior Management Personnel</i> ” on 256
“SHA” or “Shareholders’ Agreement”	Shareholders’ agreement dated July 7, 2018 entered into by and among our Company, our Promoters, the Investor Selling Shareholder and certain other parties, as amended and supplemented pursuant to deed of adherence dated December 3, 2019, deed of adherence dated October 11, 2021 and deed of adherence dated January 24, 2022 and further amended pursuant to the SHA Amendment Agreement and SHA Second Amendment Agreement
“SHA Amendment Agreement” or “Shareholders Amendment Agreement”	Waiver cum amendment agreement dated May 3, 2023, to the Shareholders’ Agreement, entered between our Company, our Promoters, the Investor Selling Shareholder and certain other parties
SHA Second Amendment Agreement	Second amendment agreement dated August 30, 2023, to the Shareholders’ Agreement, entered between our Company, our Promoters, the Investor Selling Shareholder and certain other parties
Scheme of Amalgamation 2014	Scheme of amalgamation of Global Electrical Factory (India) Limited and RSquare Realty Private Limited with our Company approved by the Hon’ble High Court of Judicature at Bombay <i>vide</i> its order dated September 12, 2014
Scheme of Amalgamation 2020	Scheme of amalgamation of Ram Ratna Electricals Limited with our Company approved by the National Company Law Tribunal, Ahmedabad and National Company Law Tribunal, Mumbai <i>vide</i> the orders dated July 22, 2020 and August 19, 2020, respectively

Term	Description
Shareholder(s)	Equity shareholder(s) of our Company from time to time
Stakeholders' Relationship Committee	Stakeholders' relationship committee of our Board, as described in "Our Management – Committees of the Board" on page 249
"Statutory Auditors" or "Auditors"	B S R & Co. LLP, Chartered Accountants, the statutory auditors of our Company

Offer Related Terms

Term	Description
Abridged Prospectus	The memorandum containing such salient features of a prospectus as may be specified by SEBI in this regard
Acknowledgement Slip	The slip or document issued by the relevant Designated Intermediary(ies) to a Bidder as proof of registration of the Bid cum Application Form
"Allot", "Allotment" or "Allotted"	Unless the context otherwise requires, allotment of the Equity Shares pursuant to the Fresh Issue and transfer of the Equity Shares by the Selling Shareholders pursuant to the Offer for Sale to the successful Bidders
Allotment Advice	A note or advice or intimation of Allotment sent to the successful Bidders who have been or are to be Allotted the Equity Shares after the Basis of Allotment has been approved by the Designated Stock Exchange
Allottee	A successful Bidder to whom the Equity Shares are Allotted
Anchor Investor(s)	A Qualified Institutional Buyer, applying under the Anchor Investor Portion in accordance with the requirements specified in the SEBI ICDR Regulations and this Red Herring Prospectus and who has Bid for an amount of at least ₹100 million
Anchor Investor Allocation Price	The price at which Equity Shares will be allocated to the Anchor Investors in terms of this Red Herring Prospectus and the Prospectus, which will be decided by our Company and the Investor Selling Shareholder, in consultation with the Book Running Lead Managers
Anchor Investor Application Form	The application form used by an Anchor Investor to make a Bid in the Anchor Investor Portion and which will be considered as an application for Allotment in terms of this Red Herring Prospectus and the Prospectus
"Anchor Investor Bidding Date" or "Anchor Investor Bid/ Offer Period"	The day, being one Working Day prior to the Bid / Offer Opening Date i.e. Tuesday, September 12, 2023, on which Bids by Anchor Investors shall be submitted, prior to and after which the Book Running Lead Managers will not accept any Bids from Anchor Investors, and allocation to Anchor Investors shall be completed
Anchor Investor Offer Price	The final price at which the Equity Shares will be Allotted to the Anchor Investors in terms of this Red Herring Prospectus and the Prospectus, which price will be equal to or higher than the Offer Price but not higher than the Cap Price The Anchor Investor Offer Price will be decided by our Company and the Investor Selling Shareholder, in consultation with the Book Running Lead Managers
Anchor Investor Pay-in Date	With respect to Anchor Investor(s), the Anchor Investor Bid/Offer Period, and in the event the Anchor Investor Allocation Price is lower than the Anchor Investor Offer Price, not later than two Working Days after the Bid/ Offer Closing Date
Anchor Investor Portion	Up to 60% of the QIB Portion which may be allocated by our Company and the Investor Selling Shareholder, in consultation with the Book Running Lead Managers, to the Anchor Investors on a discretionary basis in accordance with the SEBI ICDR Regulations One-third of the Anchor Investor Portion shall be reserved for domestic Mutual Funds, subject to valid Bids being received from domestic Mutual Funds at or above the Anchor Investor Allocation Price
"Application Supported by Blocked Amount" or "ASBA"	An application, whether physical or electronic, used by ASBA Bidders, to make a Bid and authorising an SCSB to block the Bid Amount in the ASBA Account and will include amounts blocked by the SCSB upon acceptance of UPI Mandate Request by the UPI Bidders using the UPI Mechanism
ASBA Account	A bank account maintained by ASBA Bidders with an SCSB and specified in the ASBA Form submitted by such ASBA Bidder in which funds will be blocked by such SCSB to the extent of the amount specified in the ASBA Form submitted by such ASBA Bidder and includes a bank account maintained by a UPI Bidder linked to a UPI ID, which will be blocked by the SCSB upon acceptance of the UPI Mandate Request in relation to a Bid by a UPI Bidder
ASBA Bid	A Bid made by an ASBA Bidder
ASBA Bidders	All Bidders except Anchor Investors
ASBA Form	An application form, whether physical or electronic, used by ASBA Bidders to submit Bids, which will be considered as the application for Allotment in terms of this Red Herring Prospectus and the Prospectus
Axis	Axis Capital Limited
Banker(s) to the Offer	Collectively, the Escrow Collection Bank, Refund Bank, Public Offer Bank and Sponsor Banks

Term	Description
Basis of Allotment	The basis on which Equity Shares will be Allotted to successful Bidders under the Offer. For details, see “Offer Procedure” beginning on page 436
Bid(s)	An indication to make an offer during the Bid/Offer Period by an ASBA Bidder pursuant to submission of the ASBA Form, or during the Anchor Investor Bid/Offer Period by an Anchor Investor, pursuant to submission of the Anchor Investor Application Form, to subscribe to or purchase the Equity Shares at a price within the Price Band, including all revisions and modifications thereto as permitted under the SEBI ICDR Regulations and in terms of this Red Herring Prospectus and the Bid cum Application Form. The term “Bidding” shall be construed accordingly
Bid Amount	The highest value of optional Bids indicated in the Bid cum Application Form and, in the case of RIBs Bidding at the Cut off Price, the Cap Price multiplied by the number of Equity Shares Bid for by such Retail Individual Bidder and mentioned in the Bid cum Application Form and payable by the Bidder or blocked in the ASBA Account of the Bidder, as the case may be, upon submission of the Bid. However, Eligible Employees applying in the Employee Reservation Portion can apply at the Cut-off Price and the Bid amount shall be Cap Price, multiplied by the number of Equity Shares Bid for by such Eligible Employee and mentioned in the Bid cum Application Form
Bid cum Application Form	Anchor Investor Application Form or the ASBA Form, as the context requires
Bid Lot	[●] Equity Shares and in multiples of [●] Equity Shares thereafter
Bid/Offer Closing Date	Except in relation to any Bids received from the Anchor Investors, the date after which the Designated Intermediaries will not accept any Bids, being September 15, 2023, which shall be published in all editions of English national daily newspaper, The Financial Express, all editions of Hindi national daily newspaper, Jansatta, and the Mumbai edition of the Marathi daily newspaper, Navshakti (Marathi being the regional language of Maharashtra, where our Registered Office is located). In case of any revisions, the extended Bid/ Offer Closing Date will be widely disseminated by notification to the Stock Exchanges, by issuing a public notice, and also by indicating the change on the websites of the Book Running Lead Managers and at the terminals of the other members of the Syndicate and by intimation to the Designated Intermediaries and the Sponsor Banks and shall also be notified in an advertisement in the same newspapers in which the Bid/ Offer Opening Date was published, as required under SEBI ICDR Regulations.
Bid/Offer Opening Date	Except in relation to any Bids received from the Anchor Investors, the date on which the Designated Intermediaries shall start accepting Bids, being September 13, 2023, which shall be published in all editions of English national daily newspaper, The Financial Express, all editions of Hindi national daily newspaper, Jansatta and the Mumbai edition of the Marathi daily newspaper, Navshakti (Marathi being the regional language of Maharashtra, where our Registered Office is located), each with wide circulation
Bid/Offer Period	Except in relation to Anchor Investors, the period between the Bid/Offer Opening Date and the Bid/Offer Closing Date, inclusive of both days, during which prospective Bidders (except Anchor Investors) can submit their Bids, including any revisions thereof, in accordance with the SEBI ICDR Regulations, provided that such period shall be kept open for a minimum of three Working Days.
“Bidder” or “Applicant”	Any prospective investor who makes a Bid pursuant to the terms of this Red Herring Prospectus and the Bid cum Application Form and unless otherwise stated or implied, which includes an ASBA Bidder and an Anchor Investor
Bidding Centres	The centres at which the Designated Intermediaries shall accept the Bid cum Application Forms, being the Designated Branches for SCSBs, Specified Locations for the Syndicate, Broker Centres for Registered Brokers, Designated RTA Locations for RTAs and Designated CDP Locations for CDPs
Book Building Process	Book building process, as provided in Part A of Schedule XIII of the SEBI ICDR Regulations, in terms of which the Offer is being made
“Book Running Lead Managers” or “BRLMs”	The book running lead managers to the Offer namely, Axis Capital Limited, Citigroup Global Markets India Private Limited, HSBC Securities and Capital Markets (India) Private Limited and JM Financial Limited
Broker Centres	Broker centres notified by the Stock Exchanges where ASBA Bidders can submit the ASBA Forms to a Registered Broker. The details of such Broker Centres, along with the names and the contact details of the Registered Brokers are available on the respective websites of the Stock Exchanges (www.bseindia.com and www.nseindia.com)
Cap Price	The higher end of the Price Band, above which the Offer Price and Anchor Investor Offer Price will not be finalised and above which no Bids will be accepted. The Cap Price shall be at least 105% of the Floor Price and less than or equal to 120% of the Floor Price.
Cash Escrow and Sponsor Bank Agreement	The cash escrow and sponsor bank agreement dated September 6, 2023, to be entered into between our Company, the Selling Shareholders, the Book Running Lead Managers, the Registrar to the Offer, the Bankers to the Offer for, <i>inter alia</i> , collection of the Bid Amounts from the Anchor Investors, transfer of funds to the Public Offer Account and where applicable, refunds of the amounts collected from the Anchor Investors, on the terms and conditions thereof, in accordance with the UPI Circulars

Term	Description
Citi	Citigroup Global Markets India Private Limited
Client ID	The client identification number maintained with one of the Depositories in relation to demat account
“Collecting Depository Participant” or “CDP”	A depository participant as defined under the Depositories Act, 1996, registered with SEBI and who is eligible to procure Bids from relevant Bidders at the Designated CDP Locations in terms of SEBI circular number CIR/CFD/POLICYCELL/11/2015 dated November 10, 2015 as per the list available on the respective websites of the Stock Exchanges, as updated from time to time
“Confirmation of Allocation Note” or “CAN”	A notice or intimation of allocation of the Equity Shares sent to Anchor Investors, who have been allocated Equity Shares, on or after the Anchor Investor Bid/Offer Period
Cut-off Price	The Offer Price finalised by our Company and the Investor Selling Shareholder, in consultation with the Book Running Lead Managers which shall be any price within the Price Band. Only Retail Individual Bidders Bidding in the Retail Portion and Eligible Employees under the Employee Reservation Portion are entitled to Bid at the Cut-off Price (net of Employee Discount). QIBs (including the Anchor Investors) and Non-Institutional Bidders are not entitled to Bid at the Cut-off Price
Demographic Details	The demographic details of the Bidders including the Bidders’ address, name of the Bidders’ father or husband, investor status, occupation, bank account details, PAN and UPI ID, where applicable
Designated Branches	Such branches of the SCSBs which shall collect the ASBA Forms from relevant Bidders, a list of which is available on the website of SEBI at https://www.sebi.gov.in/sebiweb/other/OtherAction.do?doRecognisedFpi=yes&intmId=35 , or at such other website as may be prescribed by SEBI from time to time
Designated CDP Locations	Such locations of the CDPs where relevant ASBA Bidders can submit the ASBA Forms. The details of such Designated CDP Locations, along with names and contact details of the CDPs eligible to accept ASBA Forms are available on the websites of the Stock Exchanges (www.bseindia.com and www.nseindia.com)
Designated Date	The date on which the Escrow Collection Bank(s) transfer funds from the Escrow Account to the Public Offer Account or the Refund Account, as the case may be, and the instructions are issued to the SCSBs (in case of UPI Bidders using UPI Mechanism, instruction issued through the Sponsor Banks) for the transfer of amounts blocked by the SCSBs in the ASBA Accounts to the Public Offer Account, in terms of this Red Herring Prospectus and the Prospectus, following which the Equity Shares will be Allotted in the Offer
Designated Intermediary(ies)	Collectively, the members of the Syndicate, sub-syndicate or agents, SCSBs (other than in relation to RIBs using the UPI Mechanism), Registered Brokers, CDPs and RTAs, who are authorised to collect Bid cum Application Forms from the relevant Bidders, in relation to the Offer. In relation to ASBA Forms submitted by RIBs Bidding in the Retail Portion and Eligible Employees Bidding in the Employee Reservation Portion by authorising an SCSB to block the Bid Amount in the ASBA Account, Designated Intermediaries shall mean SCSBs. In relation to ASBA Forms submitted by UPI Bidders where the Bid Amount will be blocked upon acceptance of UPI Mandate Request by such UPI Bidder using the UPI Mechanism, Designated Intermediaries shall mean Syndicate, sub-syndicate/agents, Registered Brokers, CDPs, SCSBs and RTAs. In relation to ASBA Forms submitted by QIBs and Non-Institutional Bidders (not using the UPI Mechanism), Designated Intermediaries shall mean Syndicate, sub-syndicate/ agents, SCSBs, Registered Brokers, the CDPs and RTAs
Designated RTA Locations	Such locations of the RTAs where relevant ASBA Bidders can submit the ASBA Forms to RTAs. The details of such Designated RTA Locations, along with names and contact details of the RTAs eligible to accept ASBA Forms are available on the websites of the Stock Exchanges (www.bseindia.com and www.nseindia.com)
Designated SCSB Branches	Such branches of the SCSBs which shall collect the ASBA Forms, a list of which is available on the website of SEBI at www.sebi.gov.in/sebiweb/other/OtherAction.do?doRecognised=yes or at such other website as may be prescribed by SEBI from time to time
Designated Stock Exchange	BSE
“Draft Red Herring Prospectus” or “DRHP”	The draft red herring prospectus dated May 5, 2023, filed with SEBI and issued in accordance with the SEBI ICDR Regulations, which did not contain complete particulars of the price at which the Equity Shares will be Allotted and the size of the Offer
Eligible Employee	All or any of the following: (a) a permanent employee of our Company working in India, as of the date of filing of this Red Herring Prospectus with the RoC and who continues to be a permanent employee of our Company, until the submission of the Bid cum Application Form; and (b) a Director of our Company, whether whole time or not, who is eligible to apply under the Employee Reservation Portion under applicable law as on the date of filing of this Red Herring Prospectus with the RoC and who continues to be a Director of our Company, until the submission of the Bid cum Application Form, but not including (i) Promoters; (ii) persons belonging to the Promoter Group; and (iii) Directors who either themselves or through their relatives or through any body corporate, directly or indirectly, hold more than 10% of the outstanding Equity Shares of our Company.

Term	Description
	The maximum Bid Amount under the Employee Reservation Portion by an Eligible Employee shall not exceed ₹0.50 million (net of Employee Discount). However, the initial Allotment to an Eligible Employee in the Employee Reservation Portion shall not exceed ₹0.20 million. Only in the event of under-subscription in the Employee Reservation Portion, the unsubscribed portion will be available for allocation and Allotment, proportionately to all Eligible Employees who have Bid in excess of ₹0.20 million, subject to the maximum value of Allotment made to such Eligible Employee not exceeding ₹0.50 million (net of Employee Discount)
Eligible FPI(s)	FPI(s) that are eligible to participate in the Offer in terms of applicable law and from such jurisdictions outside India where it is not unlawful to make an offer / invitation under the Offer and in relation to whom the Bid cum Application Form and this Red Herring Prospectus constitutes an invitation to purchase the Equity Shares
Eligible NRI(s)	NRI(s) eligible to invest under Schedule 3 and Schedule 4 of the FEMA Rules, from jurisdictions outside India where it is not unlawful to make an offer or invitation under the Offer and in relation to whom the Bid cum Application Form and this Red Herring Prospectus will constitute an invitation to purchase the Equity Shares
Employee Discount	A discount of up to [●]% to the Offer Price (equivalent of ₹[●] per Equity Share) as may be offered by our Company and the Investor Selling Shareholder, in consultation with the BRLMs, to Eligible Employees and which shall be announced at least two Working Days prior to the Bid/Offer Opening Date
Employee Reservation Portion	The portion of the Offer being up to [●] Equity Shares, aggregating to ₹108.00 million available for allocation to Eligible Employees, on a proportionate basis. Such portion shall not exceed 5% of the post-Offer Equity Share capital of the Company
Escrow Account(s)	The ‘no-lien’ and ‘non-interest bearing’ account(s) opened with the Escrow Collection Bank and in whose favour the Bidders (excluding the ASBA Bidders) will transfer money through direct credit/NEFT/RTGS/NACH in respect of the Bid Amount when submitting a Bid
Escrow Collection Bank	Bank, which is clearing member and registered with SEBI as a banker to an issue under the SEBI BTI Regulations and with whom the Escrow Account will be opened, in this case being, ICICI Bank Limited
“First Bidder” or “Sole Bidder”	The Bidder whose name shall be mentioned in the Bid cum Application Form or the Revision Form and in case of joint Bids, whose name also appears as the first holder of the beneficiary account held in joint names
Floor Price	The lower end of the Price Band, subject to any revision thereto, not being less than the face value of the Equity Shares at or above which the Offer Price and the Anchor Investor Offer Price will be finalised and below which no Bids will be accepted
Fraudulent Borrower	Fraudulent borrower as defined under Regulation 2(1)(III) of the SEBI ICDR Regulations
Fresh Issue	Fresh issue of up to [●] Equity Shares aggregating up to ₹1,800.00 million by our Company
Fugitive Economic Offender	An individual who is declared a fugitive economic offender under Section 12 of the Fugitive Economic Offenders Act, 2018
“General Information Document” or “GID”	The General Information Document for investing in public issues, prepared and issued in accordance with the SEBI circular (SEBI/HO/CFD/DIL1/CIR/P/2020/37) dated March 17, 2020 and the UPI Circulars. The General Information Document shall be available on the websites of the Stock Exchanges, and the Book Running Lead Managers
Gross Proceeds	Gross proceeds of the Fresh Issue that will be available to our Company
HSBC	HSBC Securities and Capital Markets (India) Private Limited
Investor Selling Shareholder	TPG Asia VII SF Pte. Ltd.
JM	JM Financial Limited
Materiality Policy	The policy adopted by our Board on August 30, 2023, for identification of material outstanding litigation involving our Company, Directors or Promoters, in accordance with the disclosure requirements under the SEBI ICDR Regulations, for the purposes of disclosure in the Draft Red Herring Prospectus, this Red Herring Prospectus and the Prospectus
Monitoring Agency	ICRA Limited
Monitoring Agency Agreement	The agreement dated September 6, 2023, entered into between and amongst our Company and the Monitoring Agency
Mutual Fund Portion	Up to 5% of the Net QIB Portion or [●] Equity Shares which shall be available for allocation to Mutual Funds only on a proportionate basis, subject to valid Bids being received at or above the Offer Price
Mutual Funds	Mutual funds registered with SEBI under the Securities and Exchange Board of India (Mutual Funds) Regulations, 1996
Net Offer	The Offer less the Employee Reservation Portion
Net Proceeds	Proceeds of the Fresh Issue less Offer expenses. For details in relation to use of the Net Proceeds and the Offer expenses, see “Objects of the Offer” beginning on page 113

Term	Description
Net QIB Portion	The portion of the QIB Portion less the number of Equity Shares Allotted to the Anchor Investors
“Non-Institutional Bidders” or “NIBs” or “NIIs”	All Bidders that are not QIBs, RIBs or Eligible Employees Bidding in the Employee Reservation Portion and who have Bid for Equity Shares, for an amount of more than ₹0.20 million (but not including NRIs other than Eligible NRIs)
Non-Institutional Portion	<p>The portion of the Offer being not less than 15% of the Net Offer comprising of [●] Equity Shares which shall be available for allocation to NIIs in accordance with the SEBI ICDR Regulations, to Non-Institutional Bidders, subject to valid Bids being received at or above the Offer Price.</p> <p>The allocation to the NIIs shall be as follows:</p> <p>a) One-third of the Non-Institutional Portion shall be reserved for applicants with an application size of more than ₹0.20 million and up to ₹1.00 million; and</p> <p>b) Two-thirds of the Non-Institutional Portion shall be reserved for applicants with an application size of more than ₹1.00 million</p> <p>Provided that the unsubscribed portion in either of the sub-categories specified in clauses (a) or (b), may be allocated to applicants in the other sub-category of non-institutional investors</p>
Non-Resident	A person resident outside India, as defined under FEMA and includes NRIs, FPIs and FVCIs
“Non-Resident Indians” or “NRI(s)”	A non-resident Indian as defined under the FEMA Rules
Offer	The initial public offer of up to [●] Equity Shares of face value of ₹5 each for cash at a price of ₹[●] each (including a share premium of ₹[●] per Equity Share), aggregating up to ₹[●] million, comprising of the Fresh Issue, Offer for Sale, and the Employee Reservation Portion
Offer for Sale	Offer for Sale of up to 754,417 Equity Shares aggregating up to ₹[●] million by Mahendrakumar Rameshwarlal Kabra, up to 754,417 Equity Shares aggregating up to ₹[●] million by Hemant Mahendrakumar Kabra, up to 754,417 Equity Shares aggregating up to ₹[●] million by Sumeet Mahendrakumar Kabra, up to 707,200 Equity Shares aggregating up to ₹[●] million by Kabel Buildcon Solutions Private Limited, up to 1,364,480 Equity Shares aggregating up to ₹[●] million by Ram Ratna Wires Limited and up to 12,901,877 Equity Shares aggregating up to ₹[●] million by TPG Asia VII SF Pte. Ltd.
Offer Agreement	The offer agreement dated May 5, 2023, entered into between our Company, the Selling Shareholders and the Book Running Lead Managers, pursuant to which certain arrangements are agreed upon in relation to the Offer
Offer Price	<p>The final price at which Equity Shares will be Allotted to ASBA Bidders in terms of this Red Herring Prospectus and the Prospectus. Equity Shares will be Allotted to Anchor Investors at the Anchor Investor Offer Price in terms of this Red Herring Prospectus.</p> <p>The Offer Price will be decided by our Company and the Investor Selling Shareholder, in consultation with the Book Running Lead Managers on the Pricing Date.</p> <p>A discount of up to [●]% on the Offer Price (equivalent of ₹[●] per Equity Share) may be offered to Eligible Employees bidding in the Employee Reservation Portion. This Employee Discount (if any) will be decided by our Company and the Investor Selling Shareholder, in consultation with the Book Running Lead Managers, on the Pricing Date in accordance with the Book Building Process and this Red Herring Prospectus</p>
Offer Proceeds	The proceeds of the Fresh Issue which shall be available to our Company and the proceeds of the Offer for Sale which shall be available to the Selling Shareholders. For further information about use of the Offer Proceeds, see “ <i>Objects of the Offer</i> ” on page 113
Offered Shares	Up to 17,236,808 Equity Shares offered by the Selling Shareholders in the Offer for Sale comprising of up to 754,417 Equity Shares aggregating up to ₹[●] million by Mahendrakumar Rameshwarlal Kabra, up to 754,417 Equity Shares aggregating up to ₹[●] million by Hemant Mahendrakumar Kabra, up to 754,417 Equity Shares aggregating up to ₹[●] million by Sumeet Mahendrakumar Kabra, up to 707,200 Equity Shares aggregating up to ₹[●] million by Kabel Buildcon Solutions Private Limited, up to 1,364,480 Equity Shares aggregating up to ₹[●] million by Ram Ratna Wires Limited and up to 12,901,877 Equity Shares aggregating up to ₹[●] million by TPG Asia VII SF Pte. Ltd.
Other Selling Shareholder	Ram Ratna Wires Limited
Price Band	<p>The price band of a minimum price of ₹[●] per Equity Share (Floor Price) and the maximum price of ₹[●] per Equity Share (Cap Price) including revisions thereof.</p> <p>The Price Band and the minimum Bid Lot for the Offer will be decided by our Company and the Investor Selling Shareholder, in consultation with the Book Running Lead Managers, and will be advertised in all editions of English national daily newspaper, The Financial Express, all editions of Hindi national daily newspaper, Jansatta, and the Mumbai edition of the Marathi daily newspaper, Navshakti (Marathi being the regional language of Maharashtra, where our registered office is located), each with a wide circulation, at least two Working Days prior to the Bid/Offer Opening Date, with the relevant financial ratios calculated at the Floor price and at the Cap Price, and shall be available to the Stock Exchanges for the purpose of uploading on their respective websites</p>

Term	Description
Pricing Date	The date on which our Company and the Investor Selling Shareholder, in consultation with the Book Running Lead Managers, will finalise the Offer Price
Promoter Group Selling Shareholders	Collectively, Hemant Mahendrakumar Kabra, Sumeet Mahendrakumar Kabra and Kabel Buildcon Solutions Private Limited
Promoter Selling Shareholder	Mahendrakumar Rameshwarlal Kabra
Prospectus	The prospectus to be filed with the RoC on or after the Pricing Date in accordance with Section 26 of the Companies Act, and the SEBI ICDR Regulations containing, <i>inter alia</i> , the Offer Price that is determined at the end of the Book Building Process, the size of the Offer and certain other information including any addenda or corrigenda thereto
Public Offer Account	The 'no-lien' and 'non-interest bearing' account to be opened, in accordance with Section 40(3) of the Companies Act, with the Public Offer Bank to receive monies from the Escrow Account and the ASBA Accounts on the Designated Date
Public Offer Bank	The bank which is a clearing member and registered with SEBI as a banker to an issue, and with whom the Public Offer Account for collection of Bid Amounts from Escrow Accounts and ASBA Accounts will be opened, in this case being Axis Bank Limited
"QIBs" or "QIB Bidders" or "Qualified Institutional Buyers"	Qualified institutional buyers as defined under Regulation 2(1)(ss) of the SEBI ICDR Regulations
QIB Portion	The portion of the Offer (including the Anchor Investor Portion) being not more than 50% of the Net Offer comprising [●] Equity Shares which shall be allocated to QIBs (including Anchor Investors), subject to valid Bids being received at or above the Offer Price
"Red Herring Prospectus" or "RHP"	This red herring prospectus dated September 6, 2023, issued by our Company in accordance with Section 32 of the Companies Act, and the provisions of the SEBI ICDR Regulations, which does not have complete particulars of the price at which the Equity Shares will be offered and the size of the Offer, including any addenda or corrigenda thereto. This Red Herring Prospectus will be filed with the RoC at least three Working Days before the Bid / Offer Opening Date and will become the Prospectus upon filing with the RoC after the Pricing Date
Refund Account(s)	The 'no-lien' and 'non-interest bearing' account opened with the Refund Bank, from which refunds, if any, of the whole or part, of the Bid Amount to the Anchor Investors shall be made
Refund Bank	The Banker to the Offer with whom the Refund Account(s) will be opened, in this case being ICICI Bank Limited
Registered Brokers	The stockbrokers registered with the stock exchanges having nationwide terminals, other than the members of the Syndicate and eligible to procure Bids
Registrar Agreement	Registrar agreement dated May 5, 2023, entered into between our Company, the Selling Shareholders and the Registrar to the Offer, in relation to the responsibilities and obligations of the Registrar to the Offer pertaining to the Offer
"Registrar to the Offer" or "Registrar"	Link Intime India Private Limited
"Retail Individual Bidder(s)" or "RIB(s)"	Individual Bidders submitting Bids, who have Bid for the Equity Shares for an amount not more than ₹0.20 million in any of the bidding options in the Offer (including HUFs applying through their Karta) and Eligible NRIs
Resident Indian	A person resident in India, as defined under FEMA
Retail Portion	The portion of the Offer being not less than 35% of the Net Offer comprising of [●] Equity Shares, which shall be available for allocation to RIBs in accordance with the SEBI ICDR Regulations, subject to valid Bids being received at or above the Offer Price
Revision Form	The form used by Bidders to modify the quantity of the Equity Shares or the Bid Amount in any of their Bid cum Application Forms or any previous Revision Form(s), as applicable. QIB Bidders and Non-Institutional Bidders are not allowed to withdraw or lower their Bids (in terms of quantity of Equity Shares or the Bid Amount) at any stage. Retail Individual Bidders and Eligible Employees Bidding in the Employee Reservation Portion can revise their Bids during the Bid/ Offer Period and withdraw their Bids until Bid/Offer Closing Date
"RTAs" or "Registrar and Share Transfer Agents"	The registrar and share transfer agents registered with SEBI and eligible to procure Bids from relevant Bidders at the Designated RTA Locations in terms of SEBI circular number CIR/CFD/POLICYCELL/11/2015 dated November 10, 2015 and SEBI master circular number SEBI/HO/MIRSD/POD-1/P/CIR/2023/70 dated May 17, 2023 issued by SEBI and available on the websites of the Stock Exchanges at www.nseindia.com and www.bseindia.com
SCORES	Securities and Exchange Board of India Complaints Redress System
"Self Certified Syndicate Bank(s)" or "SCSB(s)"	The banks registered with SEBI, offering services (i) in relation to ASBA (other than through UPI Mechanism), a list of which is available on the website of SEBI at https://www.sebi.gov.in/sebiweb/other/OtherAction.do?doRecognisedFpi=yes&intmId=34 or https://www.sebi.gov.in/sebiweb/other/OtherAction.do?doRecognisedFpi=yes&intmId=35 , as applicable, or such other website as updated from time to time, and (ii) in relation to ASBA (through UPI Mechanism), a list of which is available on the website of SEBI at

Term	Description
	<p>https://sebi.gov.in/sebiweb/other/OtherAction.do?doRecognisedFpi=yes&intmId=40 or such other website as may be prescribed by SEBI and updated from time to time</p> <p>In relation to Bids (other than Bids by Anchor Investor) submitted to a member of the Syndicate, the list of branches of the SCSBs at the Specified Locations named by the respective SCSBs to receive deposits of Bid cum Application Forms from the members of the Syndicate is available on the website of the SEBI (https://www.sebi.gov.in/sebiweb/other/OtherAction.do?doRecognisedFpi=yes&intmId=35) and updated from time to time. For more information on such branches collecting Bid cum Application Forms from the Syndicate at Specified Locations, see the website of the SEBI at https://www.sebi.gov.in/sebiweb/other/OtherAction.do?doRecognisedFpi=yes&intmId=35 as updated from time to time.</p> <p>In accordance with SEBI Circular No. SEBI/HO/CFD/DIL2/CIR/P/2019/76 dated June 28, 2019, SEBI Circular No. SEBI/HO/CFD/DIL2/CIR/P/2019/85 dated July 26, 2019, SEBI Circular No. SEBI/HO/CFD/DIL2/CIR/P/2022/45 dated April 5, 2022, read with other applicable UPI Circulars, UPI Bidders may apply through the SCSBs and mobile applications, whose names appears on the SEBI website. A list of SCSBs and mobile applications, which, are live for applying in public issues using UPI mechanism is provided in the list available on the website of SEBI at www.sebi.gov.in/sebiweb/other/OtherAction.do?doRecognisedFpi=yes&intmId=43 and updated from time to time and at such other websites as may be prescribed by SEBI from time to time</p>
Selling Shareholders	Together, the Promoter Selling Shareholder, the Promoter Group Selling Shareholders, the Other Selling Shareholder and the Investor Selling Shareholder
Share Escrow Agent	The share escrow agent to be appointed pursuant to the Share Escrow Agreement namely, Link Intime India Private Limited
Share Escrow Agreement	Share escrow agreement dated September 5, 2023, entered into between our Company, the Selling Shareholders and the Share Escrow Agent in connection with the transfer of Equity Shares under the Offer for Sale by the Selling Shareholders for the purposes of credit of such Equity Shares to the demat accounts of the Allottees in accordance with the Basis of Allotment
Specified Locations	The Bidding centres where the Syndicate shall accept Bid cum Application Forms from relevant Bidders, a list of which is available on the website of SEBI (www.sebi.gov.in), and updated from time to time
Sponsor Banks	Axis Bank Limited and ICICI Bank Limited, being Bankers to the Offer registered with SEBI, appointed by our Company to act as conduits between the Stock Exchanges and NPCI in order to push the mandate collect requests and / or payment instructions of the RIBs using the UPI Mechanism, in terms of the UPI Circulars
Syndicate Agreement	Syndicate agreement dated September 6, 2023, entered into between our Company, the Selling Shareholders, the Registrar and the members of the Syndicate in relation to collection of Bid cum Application Forms by the Syndicate
Syndicate Member	Intermediary (other than the Book Running Lead Managers) registered with SEBI who is permitted to accept bids, applications and place order with respect to the Offer, namely, JM Financial Services Limited
Sub-Syndicate Members	The sub-syndicate members, if any, appointed by the Book Running Lead Managers and the Syndicate Members, to collect ASBA Forms and Revision Forms
“Syndicate” or “members of the Syndicate”	Together, the Book Running Lead Managers and the Syndicate Member
Technopak	Technopak Advisors Private Limited
Technopak Report	Report titled “ <i>Consumer Electrical Industry in India</i> ” dated August 30, 2023, issued by Technopak and which has been commissioned and paid for by our Company
Underwriters	[•]
Underwriting Agreement	Underwriting agreement to be entered into between our Company, the Selling Shareholders and the Underwriters, on or after the Pricing Date, but prior to filing the Prospectus with the RoC
UPI	Unified payments interface which is an instant payment mechanism, developed by NPCI
UPI Bidders	<p>Collectively, individual investors applying as (i) Retail Individual Bidders in the Retail Portion, (ii) Eligible Employees, under the Employee Reservation Portion, and (iii) Non-Institutional Bidders with an application size of up to ₹0.50 million in the Non-Institutional Portion, and Bidding under the UPI Mechanism through ASBA Form(s) submitted with Syndicate Members, Registered Brokers, Collecting Depository Participants and Registrar and Share Transfer Agents.</p> <p>Pursuant to Circular no. SEBI/HO/CFD/DIL2/P/CIR/P/2022/45 dated April 5, 2022 issued by SEBI, all individual investors applying in public issues where the application amount is up to ₹0.50 million using UPI Mechanism, shall provide their UPI ID in the bid-cum-application form submitted with: (i) a syndicate member, (ii) a stock broker registered with a recognized stock exchange (whose name is mentioned on the website of the stock exchange as eligible for such activity), (iii) a depository participant (whose name is mentioned on the website of the stock exchange as eligible for such activity), and (iv) a registrar to an issue and share transfer agent (whose name is mentioned on the website of the stock exchange as eligible for such activity)</p>

Term	Description
UPI Circulars	SEBI circular no. CFD/DIL2/CIR/P/2018/22 dated February 15, 2018, SEBI circular no. SEBI/HO/CFD/DIL2/CIR/P/2018/138 dated November 1, 2018, SEBI circular no. SEBI/HO/CFD/DIL2/CIR/P/2019/50 dated April 3, 2019, SEBI circular no. SEBI/HO/CFD/DIL2/CIR/P/2019/76 dated June 28, 2019, SEBI circular no. SEBI/HO/CFD/DIL2/CIR/P/2019/85 dated July 26, 2019, SEBI circular no. SEBI/HO/CFD/DCR2/CIR/P/2019/133 dated November 8, 2019, SEBI circular no. SEBI/HO/CFD/DIL2/CIR/P/2020/50 dated March 30, 2020, SEBI circular no. SEBI/HO/CFD/DIL2/CIR/P/2021/2480/1/M dated March 16, 2021, SEBI circular no. SEBI/HO/CFD/DIL1/CIR/P/2021/47 dated March 31, 2021, SEBI circular no. SEBI/HO/CFD/DIL2/P/CIR/2021/570 dated June 2, 2021, SEBI circular no. SEBI/HO/CFD/DIL2/CIR/P/2022/45 dated April 5, 2022, SEBI circular no. SEBI/HO/CFD/DIL2/CIR/P/2022/51 dated April 20, 2022, read along with SEBI RTA Master Circular, SEBI circular number SEBI/HO/CFD/DIL2/P/CIR/2022/75 dated May 30, 2022, SEBI master circular with circular no. SEBI/HO/MIRSD/POD-1/P/CIR/2023/70 dated May 17, 2023 (to the extent that such circulars pertain to the UPI Mechanism), SEBI master circular no. SEBI/HO/CFD/PoD-2/P/CIR/2023/00094 dated June 21, 2023, SEBI circular no. SEBI/HO/CFD/TPD1/CIR/P/2023/140 dated August 9, 2023, along with the circular issued by the National Stock Exchange of India Limited having reference no. 25/2022 dated August 3, 2022 and the circular issued by BSE Limited having reference no. 20220803-40 dated August 3, 2022 and any subsequent circulars or notifications issued by SEBI in this regard
UPI ID	ID created on the UPI for single-window mobile payment system developed by the NPCI
UPI Mandate Request	A request (intimating the UPI Bidder by way of a notification on the UPI-linked mobile application and by way of an SMS directing the UPI Bidder to such UPI mobile application) to the UPI Bidder initiated by the Sponsor Banks to authorise blocking of funds on the UPI application equivalent to Bid Amount and subsequent debit of funds in case of Allotment
UPI Mechanism	Process for applications by UPI Bidders submitted with intermediaries with UPI as mode of payment, in terms of the UPI Circulars
Wilful Defaulter	Wilful defaulter as defined under Regulation 2(1)(III) of the SEBI ICDR Regulations
Working Day(s)	All days on which commercial banks in Mumbai are open for business; provided however, with reference to (a) announcement of Price Band; and (b) Bid/Offer Period, the term Working Day shall mean all days, excluding Saturdays, Sundays and public holidays, on which commercial banks in Mumbai are open for business; and (c) the time period between the Bid/Offer Closing Date and the listing of the Equity Shares on the Stock Exchanges, "Working Day" shall mean all trading days of the Stock Exchanges, excluding Sundays and bank holidays, as per circulars issued by SEBI, including the UPI Circulars

Technical, Industry Related Terms or Abbreviations

Term	Description
Advertisement and business promotion expenses	Cost companies incurred to market their products or services to consumers
BASEC	British Approvals Service for Cables
BEE	Bureau of Energy Efficiency
BIS	Bureau of Indian Standards
BLDC	Brushless direct current
B2B	Business-to-business
B2C	Business-to-consumer
B2C Sales	Company product's end use determines whether the sale is through a B2B or B2C channel
CAGR	Compounded annual growth rate
Capital employed	Shareholders' equity plus total borrowings (current & non-current) and lease liabilities (current & non-current)
Capital expenditure	Capital expenditure relates to additions to property, plant and equipment, intangible asset, intangible assets under development (net of addition minus deletion), capital work-in-progress (net of addition minus deletion) and right-to-use asset
CDP	Carbon disclosure project
Cost of Goods Sold	Cost of materials consumed plus purchase of stock-in-trade plus changes in inventories of finished goods, stock-in-trade, work-in-progress and scrap
CPR	Construction Products Regulation
CSA	Canadian Standards Association
CSR	Corporate social responsibility
Debt to Equity ratio	Total debt divided by equity

Term	Description
EBIT	Profit for the period/ year plus finance cost plus tax expenses
EBITDA	Profit for the year/ period plus finance costs plus tax expense plus depreciation and amortization expense
EBITDA Growth	(EBITDA of current period / year minus EBITDA of previous period / year) divided by EBITDA of previous period / year
EBITDA Margin	EBITDA divided by total income
ERP	Enterprise resource planning
EV	Electric vehicle
E-beam	Electron beam
FMEG	Fast moving electrical goods
GHG	Greenhouse gas
Green KPI	Green key performance indicator
GST	Goods and services tax
HEB	Home electrical business
Inventory days	Inventory days is the average inventory divided by Cost of Goods Sold multiplied by 365 for fiscal years and 91 days for three months period
IoT	Internet of Things
LED	Light emitting diode
LME	London Metal Exchange
LSOH	Low smoke zero halogen
LT	Low tension
MCB	Miniature circuit breaker
NABL	National Accreditation Board for Testing and Calibration Laboratories
Net Debt	Current borrowings plus non-current borrowings minus cash and cash equivalents
Net Debt to EBITDA	Net Debt divided by EBITDA
Net Worth	Restated and consolidated net worth, which is the aggregate value of the paid-up share capital and all reserves created out of the profits and securities premium account and debit or credit balance of profit and loss account, after deducting the aggregate value of the accumulated losses, deferred expenditure and miscellaneous expenditure not written off, as per the restated consolidated statement of assets and liabilities, but does not include reserves created out of revaluation of assets, write-back of depreciation and amalgamation. Further, capital redemption reserve, capital reserve and share suspense account have been excluded when computing other equity since these were not created out of the profits
Network of Distributors, Dealers, Retailers	The network of distributors, dealers, retailers is used to demonstrate the extensive domestic and global distribution network of the Company
OEM	Original equipment manufacturer
PAT	Profit for the year / period
PAT Margin	Profit for the period / year divided by total income
Profit after tax growth	(PAT of current period / year minus PAT of previous period / year) divided by PAT of previous period / year
PVC	Polyvinyl chloride
REACH	Registration, Evaluation, Authorization and Restriction of Chemicals
Return on Equity	(Profit for the period/year less preference dividend) divided by average equity
Return on Capital Employed	Profit for the period/ year plus finance cost plus tax expenses (EBIT) divided by (Tangible Net Worth plus Total Debt plus Deferred Tax Liabilities)
Return on Net Worth	Profit for the period/ year divided by Net Worth at the end of the period/year
Revenue from operations	Total revenue generated by our Company from the sale of goods and rendering of services
Revenue from operations growth	Growth in Revenue from operations for the year / period
Revenue from operations (Outside India)	Total revenue generated by our Company from the sale of goods and rendering of services outside India
ROHS	Restriction of Hazardous Substances Directive
Segment revenue from operations (FMEG)	Revenue generated by our Company from the FMEG segment
Segment revenue from operations (FMEG) growth	Growth in Segment revenue from operations (FMEG) for the year / period

Term	Description
Segment revenue from operations (wires and cables)	Revenue generated by our Company from the wires and cables segment
Segment revenue from operations (wires and cables) growth	Growth in Segment revenue from operations (wires and cables) for the year / period
Tangible Net Worth	Equity share capital plus instrument entirely equity in nature plus other equity minus capital redemption reserve minus capital reserve minus share suspense account minus other intangible assets minus intangible assets under development
Total Debt	Current borrowings plus non-current borrowings
Trade Payable days	Trade payable days is the average trade payables divided by Cost of Goods Sold multiplied by 365 for fiscal years and 91 days for three months period
Trade Receivables days	Trade receivables days is the average trade receivables divided by revenue from operations multiplied by 365 for fiscal years and 91 days for three months period
TUV	Technischer Überwachungsverein
UL	Underwriters Laboratories
VDE	Verband der Elektrotechnik
W&C	Wires and cables
Working Capital Cycle	Trade receivable days plus inventory days less trade payable days
XLPE	Cross-linked polythene

Conventional and General Terms or Abbreviations

Term	Description
“₹” or “Rs.” Or “Rupees” or “INR”	Indian Rupees
AIF(s)	Alternative Investment Funds, as defined in, and registered under the SEBI AIF Regulations
BDT	Bangladeshi Taka
“Bn” or “bn”	Billion
BSE	BSE Limited
CAGR	Compounded annual growth rate
Category I AIF	AIFs who are registered as “Category I Alternative Investment Funds” under the SEBI AIF Regulations
Category I FPIs	FPIs who are registered as “Category I foreign portfolio investors” under the SEBI FPI Regulations
Category II AIF	AIFs who are registered as “Category II Alternative Investment Funds” under the SEBI AIF Regulations
Category II FPIs	FPIs who are registered as “Category II foreign portfolio investors” under the SEBI FPI Regulations
Category III AIF	AIFs who are registered as “Category III Alternative Investment Funds” under the SEBI AIF Regulations
CDSL	Central Depository Services (India) Limited
CIN	Corporate Identity Number
Companies Act, 1956	The erstwhile Companies Act, 1956 read with the rules, regulations, clarifications and modifications thereunder
“Companies Act” or “Companies Act, 2013”	Companies Act, 2013, as applicable, along with the relevant rules, regulations, clarifications and modifications made thereunder
Consolidated FDI Policy	Consolidated Foreign Direct Investment Policy notified by the DPIIT under DPIIT File Number 5(2)/2020-FDI Policy dated October 15, 2020, effective from October 15, 2020 issued by the Department of Promotion of Industry and Internal Trade, Ministry of Commerce and Industry, Government of India, and any modifications thereto or substitutions thereof, issued from time to time
CSR	Corporate social responsibility
Depositories	Together, NSDL and CDSL
Depositories Act	Depositories Act, 1996
DIN	Director Identification Number
DP ID	Depository Participant’s Identification
“DP” or “Depository Participant”	A depository participant as defined under the Depositories Act
DPIIT	Department for Promotion of Industry and Internal Trade, Ministry of Commerce and Industry, Government of India (formerly known as Department of Industrial Policy and Promotion)
EGM	Extraordinary general meeting

Term	Description
EPS	Earnings per Equity Share
ESOP	Employee Stock Option Plan
“EUR” or “€”	Euro
FDI	Foreign direct investment
FEMA	The Foreign Exchange Management Act, 1999, read with rules and regulations thereunder
FEMA Rules	Foreign Exchange Management (Non-debt Instruments) Rules, 2019
“Financial Year” or “Fiscal” or “Fiscal Year” or “FY”	Unless stated otherwise, the period of 12 months ending March 31 of that particular year
FPI	Foreign portfolio investors as defined under the SEBI FPI Regulations
FVCI	Foreign venture capital investors as defined and registered under the SEBI FVCI Regulations
“GoI” or “Government” or “Central Government”	Government of India
GST	Goods and services tax
HUF	Hindu undivided family
ICAI	The Institute of Chartered Accountants of India
IFRS	International Financial Reporting Standards
Income-tax Act	The Income-tax Act, 1961
Ind AS	Indian Accounting Standards notified under Section 133 of the Companies Act and referred to in the Companies (Indian Accounting Standards) Rules, 2015
India	Republic of India
“Indian GAAP/IGAAP”	Accounting Standards notified under Section 133 of the Companies Act and referred to in the Companies (Accounting Standards) Rules, 2014
IPO	Initial public offering
IRDAI	Insurance Regulatory and Development Authority of India
IST	Indian Standard Time
IT	Information Technology
IT Act	The Information Technology Act, 2000
KYC	Know Your Customer
MCA	Ministry of Corporate Affairs, Government of India
“Mn” or “mn”	Million
MSMEs	Small scale undertakings as per the Micro, Small and Medium Enterprises Development Act, 2006
Mutual Funds	Mutual Funds registered under the SEBI Mutual Fund Regulations
NACH	National Automated Clearing House
National Investment Fund	National Investment Fund set up by resolution F. No. 2/3/2005-DD-II dated November 23, 2005 of the GoI, published in the Gazette of India
“NAV” or “Net Asset Value”	Net asset value
NEFT	National Electronic Fund Transfer
Negotiable Instruments Act	The Negotiable Instruments Act, 1881
NPCI	National Payments Corporation of India
NRE	Non- Resident External
NRI	An individual resident outside India, who is a citizen of India.
NRO	Non-Resident Ordinary
NSDL	National Securities Depository Limited
NSE	National Stock Exchange of India Limited
“OCB” or “Overseas Corporate Body”	A company, partnership, society or other corporate body owned directly or indirectly to the extent of at least 60% by NRIs including overseas trusts, in which not less than 60% of beneficial interest is irrevocably held by NRIs directly or indirectly and which was in existence on October 3, 2003 and immediately before such date had taken benefits under the general permission granted to OCBs under FEMA. OCBs are not allowed to invest in the Offer
p.a.	Per annum
P/E Ratio	Price to Earnings Ratio
PAN	Permanent Account Number

Term	Description
PAT	Profit after tax
“Pound” or “£”	Pound Sterling
RBI	Reserve Bank of India
Regulation S	Regulation S under the U.S. Securities Act
“RoNW” or “Return on Net Worth”	Return on net worth
RTGS	Real Time Gross Settlement
Rule 144A	Rule 144A under the U.S. Securities Act
SCRA	Securities Contracts (Regulation) Act, 1956
SCRR	Securities Contracts (Regulation) Rules, 1957
SEBI	Securities and Exchange Board of India constituted under the SEBI Act
SEBI Act	Securities and Exchange Board of India Act, 1992
SEBI AIF Regulations	Securities and Exchange Board of India (Alternative Investment Funds) Regulations, 2012
SEBI BTI Regulations	Securities and Exchange Board of India (Bankers to an Issue) Regulations, 1994
SEBI FPI Regulations	Securities and Exchange Board of India (Foreign Portfolio Investors) Regulations, 2019
SEBI FUTP Regulations	Securities and Exchange Board of India (Fraudulent and Unfair Trade Practices relating to Securities Market) Regulations, 2003
SEBI FVCI Regulations	Securities and Exchange Board of India (Foreign Venture Capital Investors) Regulations, 2000
SEBI ICDR Regulations	Securities and Exchange Board of India (Issue of Capital and Disclosure Requirements) Regulations, 2018
SEBI Listing Regulations	Securities and Exchange Board of India (Listing Obligations and Disclosure Requirements) Regulations, 2015
SEBI Merchant Bankers Regulations	Securities and Exchange Board of India (Merchant Bankers) Regulations, 1992
SEBI Mutual Fund Regulations	Securities and Exchange Board of India (Mutual Funds) Regulations, 1996
SEBI RTA Master Circular	SEBI circular no. SEBI/HO/MIRSD/POD-1/P/CIR/2023/70 dated May 17, 2023
SEBI SBEB Regulations	Securities and Exchange Board of India (Share Based Employee Benefits and Sweat Equity) Regulations, 2021
SEBI Takeover Regulations	Securities and Exchange Board of India (Substantial Acquisition of Shares and Takeovers) Regulations, 2011
SEBI VCF Regulations	Securities and Exchange Board of India (Venture Capital Fund) Regulations, 1996 as repealed pursuant to the SEBI AIF Regulations
State Government	The government of a state in India
Stock Exchanges	BSE and NSE
STT	Securities Transaction Tax
Systemically Important NBFC or NBFC-SI	Systemically important non-banking financial company as defined under Regulation 2(1)(iii) of the SEBI ICDR Regulations
TAN	Tax deduction account number
U.S. QIBs	“qualified institutional buyers”, as defined in Rule 144A
U.S. Securities Act	U.S. Securities Act of 1933, as amended
“U.S.” or “USA” or “United States”	United States of America including its territories and possessions, any State of the United States, and the District of Columbia
“USD” or “US\$”	United States Dollars
VCFs	Venture capital funds as defined in and registered with the SEBI under the Securities and Exchange Board of India (Venture Capital Fund) Regulations, 1996 or the Securities and Exchange Board of India (Alternative Investment Funds) Regulations, 2012, as the case may be

SUMMARY OF THE OFFER DOCUMENT

The following is a general summary of certain disclosures included in this Red Herring Prospectus and is not exhaustive, nor does it purport to contain a summary of all the disclosures in this Red Herring Prospectus or all details relevant to prospective investors. This summary should be read in conjunction with, and is qualified in its entirety by, the more detailed information appearing elsewhere in this Red Herring Prospectus, including “Risk Factors”, “The Offer”, “Capital Structure”, “Objects of the Offer”, “Industry Overview”, “Our Business”, “Our Promoters and Promoter Group”, “Restated Consolidated Financial Information”, “Management’s Discussions and Analysis of Financial Position and Results of Operations”, “Outstanding Litigation and Material Developments”, “Offer Procedure” and “Main Provisions of Articles of Association” beginning on pages 28, 66, 81, 113, 139, 190, 259, 269, 379, 402, 436 and 454, respectively.

Primary business of our Company

We are one of the leading companies in the Indian consumer electrical industry (comprising wires and cables and fast moving electrical goods), with an operating history of over 20 years in India. We are the fastest growing consumer electrical company among our peers in India, growing at a compounded annual growth rate of 43.4% between Fiscal 2021 and Fiscal 2023. (Source: Technopak Report) We sell products across two broad segments - (i) wires and cables including house wires, industrial wires, power cables and special cables; and (ii) fast moving electrical goods including fans, lighting, switches and appliances.

Industry in which our Company operates

India is the third largest producer and the second largest consumer of electricity in the world. (Source: Technopak Report) Consumer electrical (wires and cables and fast moving electrical goods) industry is one of the important aspects of the Indian economy, contributing approximately 8% to the country’s manufacturing production, approximately 1.5% to India’s GDP and approximately 1.5% to India’s exports. (Source: Technopak Report) The consumer electrical industry consisting of wires and cables and fast moving electrical goods was estimated at approximately ₹ 1,811,500 million in Fiscal 2023 and is expected to grow at a compounded annual growth rate of approximately 10% till Fiscal 2027 to reach a market value of approximately ₹2,665,000 million. (Source: Technopak Report).

Our Promoters

Our Promoters are Tribhuvanprasad Rameshwarlal Kabra, Shreegopal Rameshwarlal Kabra, Mahendrakumar Rameshwarlal Kabra, Kirtidevi Shreegopal Kabra, Tribhuvanprasad Kabra HUF, Kabra Shreegopal Rameshwarlal HUF and Mahendra Kumar Kabra HUF. For details, see “Our Promoters and Promoter Group” beginning on page 259.

Offer size

The following table summarizes the details of the Offer. For further details, see “The Offer” and “Offer Structure” beginning on pages 66 and 433, respectively.

Offer of Equity Shares⁽¹⁾⁽²⁾	Up to [●] Equity Shares for cash at price of ₹[●] per Equity Share (including a premium of [●] per Equity Share) aggregating up to ₹[●] million.
of which:	
(i) Fresh Issue⁽¹⁾	Up to [●] Equity Shares aggregating up to ₹1,800.00 million.
(ii) Offer for Sale⁽²⁾	Up to 17,236,808 Equity Shares aggregating up to ₹[●] million.
Employee Reservation Portion⁽³⁾	Up to [●] Equity Shares aggregating up to ₹108.00 million.
Net Offer	Up to [●] Equity Shares aggregating up to ₹[●] million.

(1) The Fresh Issue has been authorised by a resolution of our Board at their meeting held on February 13, 2023, and a special resolution passed by our Shareholders at their meeting held on March 20, 2023.

(2) Each of the Selling Shareholders, severally and not jointly, has confirmed and authorized its participation in the Offer for Sale in relation to its portion of the Offered Shares as set out below:

Name of the Selling Shareholder	Number of Equity Shares held on a fully diluted basis*	Type	Number of Offered Shares	Date of corporate authorisation / board resolution	Date of consent letter
Mahendrakumar Rameshwarlal Kabra	8,648,588	Promoter Selling Shareholder	Up to 754,417 Equity Shares	N.A.	May 5, 2023
Hemant Mahendrakumar Kabra	6,799,436	Promoter Group Selling Shareholder	Up to 754,417 Equity Shares	N.A.	May 5, 2023
Sumeet Mahendrakumar Kabra	5,437,324	Promoter Group Selling Shareholder	Up to 754,417 Equity Shares	N.A.	August 31, 2023
Kabel Buildcon Solutions Private Limited	707,200	Promoter Group Selling Shareholder	Up to 707,200 Equity Shares	March 18, 2023	May 5, 2023
Ram Ratna Wires Limited	1,364,480	Other Selling Shareholder	Up to 1,364,480 Equity Shares	April 12, 2023	May 5, 2023
TPG Asia VII SF Pte. Ltd.	18,535,115	Investor Selling Shareholder	Up to 12,901,877 Equity Shares	March 9, 2023	August 31, 2023

* Assuming exercise of 91,864 vested options under ESOP 2020.

- (3) In the event of under-subscription in the Employee Reservation Portion (if any), the unsubscribed portion will be available for allocation and Allotment, proportionately to all Eligible Employees who have Bid in excess of ₹0.20 million (net of Employee Discount), subject to the maximum value of Allotment made to such Eligible Employee not exceeding ₹0.50 million (net of Employee Discount). The unsubscribed portion, if any, in the Employee Reservation Portion after allocation of up to ₹0.50 million (net of Employee Discount), shall be added to the Net Offer. Our Company and the Investor Selling Shareholder, in consultation with the BRLMs, may offer a discount of up to [●]% on the Offer Price (equivalent of ₹[●] per Equity Share) to Eligible Employees bidding in the Employee Reservation Portion which shall be announced two Working Days prior to the Bid/Offer Opening Date. For further details, see 'Offer Procedure' and 'Offer Structure' on pages 436 and 433, respectively.

The Offer and Net Offer shall constitute [●]% and [●]% of the post Offer paid up Equity Share capital of our Company, respectively.

The above table summarises the details of the Offer. For further details of the offer, see "The Offer" and "Offer Structure" beginning on pages 66 and 433, respectively.

Objects of the Offer

Our Company proposes to utilise the Net Proceeds towards funding the following objects:

Objects	Estimated Amount (in ₹ million)
Repayment or prepayment, in full or in part, of borrowings availed by our Company from banks and financial institutions	1,360.00
General corporate purposes ⁽¹⁾	[●]
Net Proceeds⁽¹⁾	[●]

⁽¹⁾ To be finalised upon determination of the Offer Price and updated in the Prospectus prior to the filing with the RoC. The amount utilised for general corporate purposes shall not exceed 25% of the Gross Proceeds from the Fresh Issue.

For further details, see "Objects of the Offer" beginning on page 113.

Aggregate pre-Offer shareholding of our Promoters and members of the Promoter Group

Category of Shareholders	No. of Equity Shares held on a fully diluted basis	% of total paid up Equity Share capital on a fully diluted basis*
Promoters		
Tribhuvanprasad Rameshwarlal Kabra	6,896,889	6.21
Shreegopal Rameshwarlal Kabra	4,629,232	4.16
Mahendrakumar Rameshwarlal Kabra	8,648,588	7.78
Kirtidevi Shreegopal Kabra	5,656,308	5.09
Tribhuvanprasad Kabra HUF	1,436,000	1.29
Kabra Shreegopal Rameshwarlal HUF	3,961,160	3.56
Mahendra Kumar Kabra HUF	1,154,208	1.04
Sub-Total (A)	32,382,385	29.13
Promoter Group (other than the Promoters)		
Anant Satyanarayan Loya	260,000	0.23
Asha Muchhal	3,308,524	2.98
Gaurishankar Satyanarayan Loya	440,000	0.40
Hemant Mahendrakumar Kabra	6,799,436	6.12
Jag-Bid Finvest Private Limited	1,344,000	1.21
Kabel Buildcon Solutions Private Limited	707,200	0.64
KGR Worldwide Solutions LLP	345,000	0.31
Kishori Dinesh Modani	84,520	0.08
Mahhesh Tribhuvanprasad Kabra	5,872,077	5.28
Priti Amit Saboo	2,684,524	2.41
Rajesh Shreegopal Kabra	4,101,812	3.69
Ram Ratna Infrastructure Private Limited	110,000	0.10
Ram Ratna Research and Holdings Private Limited	5,078,464	4.57
Saraswatidevi Satyanarayan Loya	36,000	0.03
Sarita Jhavar	4,784,881	4.30
Sumeet Mahendrakumar Kabra	5,437,324	4.89
Sub-Total (B)	41,393,762	37.24
Total (A+B)	73,776,147	66.37

* Assuming exercise of 91,864 vested options under ESOP 2020.

Aggregate pre-Offer shareholding of the Selling Shareholders

Name of Selling Shareholders	No. of Equity Shares held on a fully diluted basis	% of total paid up Equity Share capital on a fully diluted basis*
Mahendrakumar Rameshwarlal Kabra	8,648,588	7.78
Hemant Mahendrakumar Kabra	6,799,436	6.12
Sumeet Mahendrakumar Kabra	5,437,324	4.89
Kabel Buildcon Solutions Private Limited	707,200	0.64
Ram Ratna Wires Limited	1,364,480	1.23
TPG Asia VII SF Pte. Ltd.	18,535,115	16.67

* Assuming exercise of 91,864 vested options under ESOP 2020.

For further details, see “Capital Structure” beginning on page 81.

Summary of Restated Consolidated Financial Information

The following details of our Equity Share capital, Net Worth, total income, profit for the year/ period, basic earnings per Equity Share, diluted earnings per Equity Share, Net Asset Value per Equity Share for equity Shareholders and total borrowings (as per restated consolidated statement of assets and liabilities) as at and for the three months period ended June 30, 2023 and June 30, 2022 and for the financial years ended March 31, 2023, March 31, 2022 and March 31, 2021.

(in ₹ million, unless otherwise stated)

Particulars	As at and for the three months period ended		As at and for the Financial Year ended		
	June 30, 2023	June 30, 2022	March 31, 2023	March 31, 2022	March 31, 2021
Equity share capital ^{§#}	478.48	239.24	478.48	239.24	239.24
Net Worth ^{(1)*}	14,946.87	12,502.46	13,904.74	12,370.47	10,333.75
Total income	16,135.98	12,433.00	56,336.40	44,322.18	27,459.36
Profit for the year/period	743.48	181.42	1,898.72	2,139.37	1,353.98
Basic Earnings per Equity Share (in ₹)	6.69	1.63	17.09	19.26	12.19
Diluted Earnings per Equity Share (in ₹)	6.68	1.63	17.07	19.22	12.18
Net Asset Value per Equity Share (in ₹) ^{(2)*}	134.57	112.56	125.19	111.38	93.04
Total borrowings (as per restated consolidated statement of assets and liabilities) ⁽³⁾	4,037.65	5,029.92	5,158.41	5,211.11	4,987.13

*These are non-GAAP measures

Pursuant to a resolution passed by our Board on March 16, 2023 and a resolution passed by the Shareholders on March 20, 2023, each equity share of face value of ₹10 each has been split into 2 Equity Shares of face value of ₹5 each. Accordingly, the issued, subscribed and paid up capital of our Company was sub-divided from 23,924,074 equity shares of face value of ₹10 each to 47,848,148 equity shares of face value of ₹5 each. Sub-division of equity shares is retrospectively considered for the computation of EPS in accordance with Indian Accounting Standard 33 (“Ind AS 33”) for all periods presented and for the computation of Net Asset Value per Equity Share for all periods presented.

§ Our Board of Directors pursuant to a resolution dated March 16, 2023 and Shareholders pursuant to a special resolution dated March 20, 2023, have approved the issuance of 47,848,148 bonus Equity Shares in the ratio of one Equity Share for every one existing fully paid up Equity Share. Bonus Equity Shares are retrospectively considered for the computation of EPS in accordance with Ind AS 33 for all periods presented and for the computation of NAV per Equity Share for all periods presented.

- Net Worth has been defined as restated and consolidated net worth, which is the aggregate value of the paid-up share capital and all reserves created out of the profits and securities premium account and debit or credit balance of profit and loss account, after deducting the aggregate value of the accumulated losses, deferred expenditure and miscellaneous expenditure not written off, as per the restated consolidated statement of assets and liabilities, but does not include reserves created out of revaluation of assets, write-back of depreciation and amalgamation. Further, capital redemption reserve, capital reserve and share suspense account have been excluded when computing other equity since these were not created out of the profits.
- Net Asset Value per Equity Share is calculated as Net Worth at the end of the period/year divided by Weighted average number of equity shares outstanding during the period/year.
- Total borrowings includes current borrowings and non-current borrowings.

For further details, including reconciliation of non-GAAP measures, see “Financial Information” and “Other Financial Information” beginning on pages 269 and 372, respectively.

Qualifications of the Statutory Auditors which have not been given effect to in the Restated Consolidated Financial Information

There are no qualifications included by the Statutory Auditors in their audit reports and hence no effect is required to be given in the Restated Consolidated Financial Information.

Summary of Outstanding Litigation

A summary of outstanding litigation proceedings involving our Company, our Promoters, our Directors and our Group Companies as on the date of this Red Herring Prospectus as disclosed in the section titled “Outstanding Litigation and Other Material Developments” in terms of the SEBI ICDR Regulations is provided below:

Name of entity	Criminal proceedings	Tax proceedings	Statutory or regulatory proceedings	Disciplinary actions including penalty imposed by the SEBI or Stock Exchanges against our Promoters	Material civil litigations#	Aggregate amount involved* (in ₹ million)
Company						
By the Company	208 [§]	32	-	-	2	461.93
Against the Company	-	7	1	-	-	68.31
Directors						
By our Directors	-	-	-	-	-	-
Against the Directors	-	-	-	-	-	-
Promoters**						
By Promoters	-	-	-	-	-	-
Against Promoters	-	-	-	-	-	-
Group Companies						
By Group Companies	-	-	-	-	-	-
Against Group Companies	-	-	-	-	-	-

Determined in accordance with the Materiality Policy.

* To the extent quantifiable. The amount in dispute in relation to taxation matters is to the extent quantifiable as per notice of demand and excluding any further liabilities towards interest and penalty.

** Other than proceedings involving three of our Promoters, who are also Directors on our Board.

§ 205 of these matters are cases filed by our Company and Ram Ratna Electricals Limited (now amalgamated with our Company) before various forums for alleged violations of Section 138 of the Negotiable Instruments Act, 1881, involving a total amount aggregating to approximately ₹188.09 million.

For further details of the outstanding litigation proceedings, see “Outstanding Litigation and Material Developments” beginning on page 402.

Risk Factors

Specific attention of the Bidders is invited to “Risk Factors” beginning on page 28 to have an informed view before making an investment decision.

Summary of Contingent Liabilities

The summary of our contingent liabilities as per Ind AS 37 derived from our Restated Consolidated Financial Information as on June 30, 2023 are set forth in the table below:

(₹ in million)		
Sr. No.	Particulars	As at June 30, 2023
Contingent Liabilities		
1.	Service tax demands	39.20
2.	Income tax demands	31.71
3.	Sales tax / VAT demands – C Forms	96.73
4.	Labor law demand	1.91
5.	Channel financing guarantees*	225.00
Total		394.55
Commitment		
1.	On capital account (net of advance)	834.78

*Note: Our Company has arranged channel financing facilities for its customers from banks against which a sum of ₹2,697.80 million has been utilised as on the date of the balance sheet. Accordingly, the contingency on our Company on account of customers defaulting in repayment to the respective banks is ₹225.00 million (to the extent of recourse available with the bank.) as at June 30, 2023.

For details on contingent liabilities, as per Ind AS 37, see “Restated Consolidated Financial Information – Annexure VI – Notes to Restated Consolidated Financial Information - Note 28: Contingent Liabilities and Commitments” and “Management’s Discussion and Analysis of Financial Condition and Results of Operations” on pages 327 and 379, respectively.

Summary of Related Party Transactions

A summary of related party transactions as per the requirements under Ind AS 24 – Related Party Disclosures read with the SEBI ICDR Regulations entered into by our Company with related parties as at and for the three months period ended June 30, 2023 and June 30, 2022 and for the financial years ended March 31, 2023, March 31, 2022 and March 31, 2021 derived from our Restated Consolidated Financial Information is as follows:

(In ₹ million)

Particulars	For the three months period ended		For the Financial Year ended		
	June 30, 2023	June 30, 2022	March 31, 2023	March 31, 2022	March 31, 2021
Income					
Sale of Goods	810.36	702.93	2,276.77	2,149.31	1,283.29
Processing charges	0.33	0.74	2.06	0.49	0.62
Rent income	-	-	0.04	0.04	0.04
Expenses					
Purchase of Goods	45.35	37.48	134.12	52.20	12.16
Commission on sales	49.75	35.97	138.17	115.31	66.74
Rent expenses	2.59	3.14	11.70	13.28	12.47
Purchase of Capital Goods	5.11	0.64	9.04	4.59	7.29
Managerial Remuneration	23.03	29.85	100.02	95.50	76.16
Commission to directors	9.88	2.56	26.40	27.23	19.23
Commission-independent directors	1.00	-	4.81	1.20	1.20
Director Sitting Fees	1.36	0.36	2.49	1.11	1.35
Reimbursement of travelling expenses	0.98	1.03	4.60	2.61	1.26
Interest on Borrowing	-	-	-	-	25.90
Others					
Dividend Paid	-	-	386.32	216.62	-
Dividends received from quoted equity investments	-	-	7.05	1.41	0.71
Donations	-	-	-	10.60	-
Transactions of Borrowing					
Borrowings Accepted	-	-	-	-	69.75
Borrowings Repaid	-	-	-	-	587.81
Balance Receivable					
Advances to suppliers	40.76	0.33	56.58	3.01	-
Security deposits Receivable	3.13	7.49	3.13	7.49	8.42
Trade Receivable	280.42	412.16	78.43	130.09	283.48
Balance Payable					
Trade Payable	52.24	46.53	34.04	32.15	19.94

Note: All related party transactions entered during the year were in ordinary course of the business and on arm's length basis.

For details of the related party transactions, see "Restated Consolidated Financial Information – Annexure VI – Notes to Restated Consolidated Financial Information - Note 33: Related party disclosures as required under Ind AS-24" on page 330.

Weighted average price at which the specified securities were acquired by the Promoters and the Selling Shareholders of the Company

Except as provided below, none of our Promoters and Selling Shareholders have acquired any specified securities in the one year preceding the date of this Red Herring Prospectus.

Name of the Shareholder	Number of Equity Shares acquired in the one year preceding the date hereof	Weighted average price of acquisition per Equity Share (in ₹)*(1)(2)
Promoters		
Tribhuvanprasad Rameshwarlal Kabra	5,676,213	Nil
Shreegopal Rameshwarlal Kabra	3,880,626	8.26
Mahendrakumar Rameshwarlal Kabra	6,486,441	Nil
Kirtidevi Shreegopal Kabra	4,242,231	Nil
Tribhuvanprasad Kabra HUF	1,077,000	Nil
Kabra Shreegopal Rameshwarlal HUF	2,980,870	337.50
Mahendra Kumar Kabra HUF	865,656	Nil
Selling Shareholders (Other than the Promoters)		
Hemant Mahendrakumar Kabra	5,099,577	Nil
Sumeet Mahendrakumar Kabra	4,902,667	Nil
Kabel Buildcon Solutions Private Limited	530,400	Nil
Ram Ratna Wires Limited	1,023,360	Nil
TPG Asia VII SF Pte. Ltd.	17,555,088	Nil

* As certified by the Independent Chartered Accountant, by way of their certificate dated September 6, 2023.

(1) Pursuant to a resolution passed by our Board on March 16, 2023 and a resolution passed by the Shareholders on March 20, 2023, each equity share of face value of ₹10 each has been split into 2 Equity Shares of face value of ₹5 each. Accordingly, the issued, subscribed and paid up capital of our Company was sub-divided from 23,924,074 equity shares of face value of ₹10 each to 47,848,148 equity shares of face value of ₹5 each.

- (2) Our Board of Directors pursuant to a resolution dated March 16, 2023 and Shareholders pursuant to a special resolution dated March 20, 2023, have approved the issuance of 47,848,148 bonus Equity Shares in the ratio of one Equity Share for every one existing fully paid up Equity Share.

Except as provided below, none of our Promoters and Selling Shareholders have acquired any specified securities in the eighteen months preceding the date of this Red Herring Prospectus.

Name of the Shareholder	Number of Equity Shares acquired in the eighteen months preceding the date hereof	Weighted average price of acquisition per Equity Share in the eighteen months preceding the date hereof (in ₹)* ⁽¹⁾⁽²⁾
Promoters		
Tribhuvanprasad Rameshwarlal Kabra	6,331,307	Nil
Shreegopal Rameshwarlal Kabra	3,880,626	8.26
Mahendrakumar Rameshwarlal Kabra	6,486,441	Nil
Kirtidevi Shreegopal Kabra	4,242,231	Nil
Tribhuvanprasad Kabra HUF	1,077,000	Nil
Kabra Shreegopal Rameshwarlal HUF	2,980,870	337.50
Mahendra Kumar Kabra HUF	865,656	Nil
Selling Shareholders (Other than the Promoters)		
Hemant Mahendrakumar Kabra	5,099,577	Nil
Sumeet Mahendrakumar Kabra	4,902,667	Nil
Kabel Buildcon Solutions Private Limited	530,400	Nil
Ram Ratna Wires Limited	1,023,360	Nil
TPG Asia VII SF Pte. Ltd.	17,555,088	Nil

* As certified by the Independent Chartered Accountant, by way of their certificate dated September 6, 2023.

- (1) Pursuant to a resolution passed by our Board on March 16, 2023 and a resolution passed by the Shareholders on March 20, 2023, each equity share of face value of ₹10 each has been split into 2 Equity Shares of face value of ₹5 each. Accordingly, the issued, subscribed and paid up capital of our Company was sub-divided from 23,924,074 equity shares of face value of ₹10 each to 47,848,148 equity shares of face value of ₹5 each.
- (2) Our Board of Directors pursuant to a resolution dated March 16, 2023 and Shareholders pursuant to a special resolution dated March 20, 2023, have approved the issuance of 47,848,148 bonus Equity Shares in the ratio of one Equity Share for every one existing fully paid up Equity Share.

For further details, see “Capital Structure – Notes to the Capital Structure – Equity share capital history of our Company” on page 82.

Average cost of acquisition for Promoters and the Selling Shareholders

Except as provided below, none of our Promoters and Selling Shareholders have acquired any specified securities as on date of this Red Herring Prospectus.

Name of the Promoter / Selling Shareholder	Number of Equity Shares held on a fully diluted basis	Average cost of Acquisition per Equity Share (in ₹)*
Promoters		
Tribhuvanprasad Rameshwarlal Kabra	6,896,889	0.62
Shreegopal Rameshwarlal Kabra	4,629,232	7.12
Mahendrakumar Rameshwarlal Kabra	8,648,588	5.42
Kirtidevi Shreegopal Kabra	5,656,308	3.77
Tribhuvanprasad Kabra HUF	1,436,000	2.46
Kabra Shreegopal Rameshwarlal HUF	3,961,160	5.82
Mahendra Kumar Kabra HUF	1,154,208	3.36
Selling Shareholders (Other than the Promoters)		
Hemant Mahendrakumar Kabra	6,799,436	7.05
Sumeet Mahendrakumar Kabra	5,437,324	7.68
Kabel Buildcon Solutions Private Limited	707,200	1.65
Ram Ratna Wires Limited	1,364,480	1.62
TPG Asia VII SF Pte. Ltd.	18,535,115	270.08

* As certified by the Independent Chartered Accountant, by way of their certificate dated September 6, 2023.

Details of price at which specified securities were acquired in the last three years preceding the date of this Red Herring Prospectus by our Promoters, members of the Promoter Group, the Selling Shareholders and the Shareholders with rights to nominate directors or have other rights, are disclosed below:

Except as stated below, there have been no Equity Shares or Preference Shares that were acquired in the last three years preceding the date of this Red Herring Prospectus, by our Promoters, members of the Promoter Group, the Selling Shareholders and Shareholders with special right to nominate one or more directors on the Board of our Company.

Name of the acquirer/ Shareholder	Date of allotment of Equity Shares	Number of equity shares acquired	Face value per equity share	Acquisition price per equity share (in ₹)*
Promoters				

Name of the acquirer/ Shareholder	Date of allotment of Equity Shares	Number of equity shares acquired	Face value per equity share	Acquisition price per equity share (in ₹)*
Tribhuvanprasad Rameshwarlal Kabra	December 23, 2020	44	10	250.00
	April 8, 2022**	3,275,468	10	Nil
	March 20, 2023#	1,220,676	5	Nil
	March 20, 2023^	2,441,352	5	Nil
	April 19, 2023##	2,014,185	5	Nil
Shreegopal Rameshwarlal Kabra	September 21, 2021##	76,820	10	Nil
	September 21, 2021##	72,830	10	Nil
	December 2, 2022	10,000	10	1,350.00
	March 20, 2023#	758,606	5	Nil
	March 20, 2023^	1,517,212	5	Nil
	April 19, 2023##	1,594,808	5	Nil
Mahendrakumar Rameshwarlal Kabra	December 23, 2020	1,03,116	10	250.00
	March 20, 2023#	2,162,147	5	Nil
	March 20, 2023^	4,324,294	5	Nil
Kirtidevi Shreegopal Kabra	December 23, 2020	16,260	10	250.00
	September 21, 2021##	149,651	10	Nil
	March 20, 2023#	1,414,077	5	Nil
	March 20, 2023^	2,828,154	5	Nil
Tribhuvanprasad Kabra HUF	March 20, 2023#	359,000	5	Nil
	March 20, 2023^	718,000	5	Nil
Kabra Shreegopal Rameshwarlal HUF	December 2, 2022	10,000	10	1,350.00
	March 20, 2023#	990,290	5	Nil
	March 20, 2023^	1,980,580	5	Nil
Mahendra Kumar Kabra HUF	December 23, 2020	8,302	10	250.00
	March 20, 2023#	288,552	5	Nil
	March 20, 2023^	577,104	5	Nil
Promoter Group				
Anant Satyanarayan Loya	March 20, 2023#	95,000	5	Nil
	March 20, 2023^	190,000	5	Nil
Asha Muchhal	March 20, 2023#	827,131	5	Nil
	March 20, 2023^	1,654,262	5	Nil
Gaurishankar Satyanarayan Loya	March 20, 2023#	140,000	5	Nil
	March 20, 2023^	280,000	5	Nil
Hemant Mahendrakumar Kabra	December 23, 2020	124,611	10	250.00
	March 20, 2023#	1,699,859	5	Nil
	March 20, 2023^	3,399,718	5	Nil
Jag-Bid Finvest Private Limited	December 23, 2020	16,000	10	250.00
	March 20, 2023#	336,000	5	Nil
	March 20, 2023^	672,000	5	Nil
Kabel Buildcon Solutions Private Limited	March 20, 2023#	176,800	5	Nil
	March 20, 2023^	353,600	5	Nil
KGR Worldwide Solutions LLP	August 28, 2023	120,000	5	990.00
	August 28, 2023	120,000	5	990.00
	August 28, 2023	105,000	5	990.00
Kishori Dinesh Modani	December 2, 2022	13,600	10	1,350.00
	March 20, 2023#	21,130	5	Nil
	March 20, 2023^	42,260	5	Nil
Mahhesh Tribhuvanprasad Kabra	December 23, 2020	16,259	10	250.00
	April 22, 2022##	818,867	10	Nil
	March 20, 2023#	1,396,084	5	Nil
	March 20, 2023^	2,792,168	5	Nil
	April 19, 2023##	287,741	5	Nil
Priti Amit Saboo	March 20, 2023#	671,131	5	Nil
	March 20, 2023^	1,342,262	5	Nil
Rajesh Shreegopal Kabra	December 23, 2020	16,261	10	250.00
	September 21, 2021##	117,480	10	Nil
		149,651	10	Nil
		98,885	10	Nil
		825,453	5	Nil
	March 20, 2023^	1,650,906	5	Nil
	April 19, 2023##	800,000	5	Nil
Ram Ratna Infrastructure Private Limited	August 28, 2023	10,000	5	990.00
	August 28, 2023	100,000	5	990.00
Ram Ratna Research and Holdings Private Limited	December 23, 2020	87,116	10	250.00
	March 20, 2023#	1,269,616	5	Nil
	March 20, 2023^	2,539,232	5	Nil
	March 20, 2023#	9,000	5	Nil

Name of the acquirer/ Shareholder	Date of allotment of Equity Shares	Number of equity shares acquired	Face value per equity share	Acquisition price per equity share (in ₹)*
Saraswatidevi Satyanarayan Loya	March 20, 2023 [^]	18,000	5	Nil
Sarita Jhavar	April 22, 2022 ^{##}	982,640	10	Nil
	March 20, 2023 [#]	1,123,035	5	Nil
	March 20, 2023 [^]	2,246,070	5	Nil
	April 19, 2023 ^{##}	287,741	5	Nil
	August 28, 2023	5,000	5	990.00
Satyanarayan Mohanlal Loya HUF	March 20, 2023 [#]	30,000	5	Nil
	March 20, 2023 [^]	60,000	5	Nil
Sumeet Mahendrakumar Kabra	December 23, 2020	124,611	10	250.00
	March 20, 2023 [#]	634,657	5	Nil
	March 20, 2023 [^]	1,269,314	5	Nil
	April 19, 2023 ^{##}	2,998,696	5	Nil
Selling Shareholders (Other than the Promoters, members of the Promoter Group and Shareholders with special right to nominate)				
Ram Ratna Wires Limited	March 20, 2023 [#]	341,120	5	Nil
	March 20, 2023 [^]	682,240	5	Nil
Shareholders with special right to nominate				
TPG Asia VII SF Pte. Ltd.	March 20, 2023 [#]	1,990,128	5	Nil
	March 20, 2023 [^]	3,980,256	5	Nil
	August 26, 2023	11,584,704	5	N.A. ⁽¹⁾

Pursuant to a resolution passed by our Board on March 16, 2023 and a resolution passed by the Shareholders on March 20, 2023, each equity share of face value of ₹10 each has been split into 2 Equity Shares of face value of ₹5 each. Accordingly, the issued, subscribed and paid up capital of our Company was sub-divided from 23,924,074 equity shares of face value of ₹10 each to 47,848,148 equity shares of face value of ₹5 each.

[^] Our Board of Directors pursuant to a resolution dated March 16, 2023 and Shareholders pursuant to a special resolution dated March 20, 2023, have approved the issuance of 47,848,148 bonus Equity Shares in the ratio of one Equity Share for every one existing fully paid up Equity Share.

* As certified by the Independent Chartered Accountant, by way of their certificate dated September 6, 2023.

\$ Calculated on a fully diluted basis.

^{##} Acquired by way of gift.

**Acquired by way of transmission.

(1) Consideration was paid at the time of allotment of Preference Shares. For further details, see “Capital Structure – Notes to the capital structure – Preference share capital history of our Company” on page 88.

Name of the acquirer/ Shareholder	Date of allotment of Preference Shares	Number of preference shares acquired	Face value per preference share*	Acquisition price per preference share (in ₹) ^{##}
Selling Shareholders				
TPG Asia VII SF Pte. Ltd.	December 23, 2020	140,568	1,080.33	1,080.33

* As certified by the Independent Chartered Accountant, by way of their certificate dated September 6, 2023.

For details of sub-division of equity shares in the last one year, see “Capital Structure – Notes to the Capital Structure – Equity share capital history of our Company” on page 82.

Issue of Equity Shares made in the last one year for consideration other than cash

Our Company has not issued any Equity Shares for consideration other than cash in the one year preceding the date of this Red Herring Prospectus.

Split or consolidation of Equity Shares in the last one year

Except as disclosed below, our Company has not undertaken split or consolidation of the equity shares of our Company in the last one year preceding the date of this Red Herring Prospectus:

Pursuant to a resolution passed by our Board on March 16, 2023 and a resolution passed by the Shareholders on March 20, 2023, each equity share of face value of ₹10 each has been split into 2 Equity Shares of face value of ₹5 each. Accordingly, the issued, subscribed and paid up capital of our Company was sub-divided from 23,924,074 equity shares of face value of ₹10 each to 47,848,148 equity shares of face value of ₹5 each. For details, see “Capital Structure– Notes to the Capital Structure – Equity share capital history of our Company” on page 82.

Financing Arrangements

There have been no financing arrangements whereby the Promoters, members of our Promoter Group, our Directors or any of their relatives, have financed the purchase by any other person of securities of our Company during a period of six months immediately preceding the date of filing of this Red Herring Prospectus.

Details of pre-IPO placement

Our Company is not contemplating a pre-IPO placement.

Exemption from complying with any provisions of securities laws, if any, granted by Securities Exchange Board of India

Our Company has not sought any exemption from the Securities Exchange Board of India from complying with any provisions of securities laws, as on the date of this Red Herring Prospectus.

CERTAIN CONVENTIONS, PRESENTATION OF FINANCIAL, INDUSTRY AND MARKET DATA

Certain Conventions

All references to “India” contained in this Red Herring Prospectus are to the Republic of India and its territories and possessions and all references herein to the “Government”, “Indian Government”, “GoI”, “Central Government” or the “State Government” are to the Government of India, central or state, as applicable.

Unless otherwise specified, any time mentioned in this Red Herring Prospectus is in Indian Standard Time (“IST”). Unless indicated otherwise, all references to a ‘year’ in this Red Herring Prospectus are to a calendar year.

Unless stated otherwise, all references to page numbers in this Red Herring Prospectus are to the page numbers of this Red Herring Prospectus.

Financial Data

Unless stated otherwise or the context otherwise requires, the financial information and financial ratios in this Red Herring Prospectus have been derived from our Restated Consolidated Financial Information. For further information, see “*Restated Consolidated Financial Information*” and “*Other Financial Information*” beginning on pages 269 and 372, respectively.

The Restated Consolidated Financial Information of our Company, comprising of the restated consolidated statement of assets and liabilities as at and for the three month periods ended June 30, 2023 and June 30, 2022 and for the financial years ended March 31, 2023, March 31, 2022 and March 31, 2021, the restated consolidated statement of profit and loss (including other comprehensive income), the restated consolidated statement of changes in equity and the restated consolidated statement of cash flows for the three month periods ended June 30, 2023 and June 30, 2022 and financial years ended March 31, 2023, March 31, 2022 and March 31, 2021, the summary statement of material accounting policies, and other explanatory information prepared in terms of the requirements of Section 26 of Part I of Chapter III of the Companies Act, SEBI ICDR Regulations and the Guidance Note on “Reports in Company Prospectuses (Revised 2019)” issued by ICAI, as amended from time to time.

Our Company’s financial year commences on April 1 and ends on March 31 of the next year. Accordingly, all references in this Red Herring Prospectus to a particular FY, Financial Year, Fiscal or Fiscal Year, unless stated otherwise, are to the 12-month period ended on March 31 of that particular calendar year.

There are significant differences between Ind AS, U.S. GAAP and IFRS. Our Company does not provide reconciliation of its financial information to IFRS or U.S. GAAP. Our Company has not attempted to explain those differences or quantify their impact on the financial data included in this Red Herring Prospectus and it is urged that you consult your own advisors regarding such differences and their impact on our financial data. Accordingly, the degree to which the financial information included in this Red Herring Prospectus will provide meaningful information is entirely dependent on the reader’s level of familiarity with Indian accounting policies and practices, the Companies Act, Ind AS and the SEBI ICDR Regulations. Any reliance by persons not familiar with Indian accounting policies and practices on the financial disclosures presented in this Red Herring Prospectus should, accordingly, be limited. For risks relating to significant differences between Ind AS and other accounting principles, see “*Risk Factors – External Risk Factors- Significant differences exist between Ind AS and other accounting principles, such as US GAAP and International Financial Reporting Standards (“IFRS”), which investors may be more familiar with and consider material to their assessment of our financial condition .*” on page 59.

Unless the context otherwise indicates, any percentage amounts or ratios (excluding certain operational metrics), relating to the financial information of our Company in this Red Herring Prospectus have been calculated on the basis of our Restated Consolidated Financial Information, as applicable.

Non-Generally Accepted Accounting Principles Financial Measures

Certain non-GAAP measures such as Net Worth, Return on Net Worth, Net Asset Value per Equity Share, EBITDA, EBITDA Growth, EBITDA Margin, PAT Margin, Tangible Net Worth, Capital Employed, Return on Capital Employed, Capital Expenditure, Return on Equity, Debt to Equity Ratio, Net Debt and Net Debt to EBITDA (“**Non-GAAP Measures**”) presented in this Red Herring Prospectus are a supplemental and useful measure of our business, performance and liquidity that are not required by, or presented in accordance with, Ind AS, Indian GAAP, or IFRS. Further, these Non-GAAP Measures are not a measurement of our financial performance or liquidity under Ind AS, Indian GAAP, or IFRS and should not be considered in isolation or construed as an alternative to cash flows, profit/ (loss) for the year/ period or any other measure of financial performance or as an indicator of our operating performance, liquidity, profitability or cash flows generated by operating, investing or financing activities derived in accordance with Ind AS, Indian GAAP, or IFRS. In addition, these Non-GAAP Measures are not standardised terms, hence a direct comparison of similarly titled Non-GAAP Measures between companies may not be possible. Other companies may calculate the Non-GAAP Measures differently from us, limiting its usefulness as a comparative measure. Although the Non-GAAP Measures are not a measure of performance calculated in accordance with applicable accounting standards, our Company’s management believes that it is useful to an investor in evaluating us because it is a widely used measure to evaluate a company’s operating performance.

Currency and Units of Presentation

All references to:

- “Rupees” or “₹” or “INR” or “Rs.” are to Indian Rupee, the official currency of the Republic of India;
- “BDT” are to Bangladesh Taka, the official currency of Bangladesh;
- “EUR” or “€” are to the Euro, the official currency of the European Union;
- “Pound” or “£” are to Pound Sterling, the official currency of the United Kingdom; and
- “U.S.D.” or “USD” or “\$” “US\$” are to United States Dollars, the official currency of the United States of America.

Our Company has presented certain numerical information in this Red Herring Prospectus in “million” units. One million represents 1,000,000 and one billion represents 1,000,000,000. However, where any figures that may have been sourced from third-party industry sources are expressed in denominations other than millions, such figures appear in this Red Herring Prospectus in such denominations as provided in the respective sources.

In this Red Herring Prospectus, any discrepancies in any table between the total and the sums of the amounts listed are due to rounding off. All figures derived from our Restated Consolidated Financial Information in decimals have been rounded off to two decimal places. Due to such rounding off, in certain instances, the sum or percentage change of such numbers may not conform exactly to the total figure given. However, where any figures may have been sourced from third-party industry sources, such figures may be rounded off to such number of decimal places as provided in such respective sources.

Exchange Rates

This Red Herring Prospectus contains conversion of certain other currency amounts into Indian Rupees that have been presented solely to comply with the SEBI ICDR Regulations. These conversions should not be construed as a representation that these currency amounts could have been, or can be converted into Indian Rupees, at any particular rate or at all.

The following table sets forth, for the periods indicated, information with respect to the exchange rate between the Rupee and the other currencies:

Currency	As of June 30, 2023 ⁽¹⁾	As of June 30, 2022	As of March 31, 2023	As of March 31, 2022 ⁽¹⁾	As of March 31, 2021 ⁽¹⁾
1 US\$	82.04	78.94	82.22	75.81	73.50
1 BDT	0.83	0.75	0.76	0.86	0.84
1 Euro	89.13	82.58	89.61	84.66	86.10
1 Pound	103.51	95.96	101.87	99.55	100.95

(Source: www.fbil.org.in, www.rbi.org.in and www.oanda.com)

⁽¹⁾ If the reference rate is not available on a particular date due to a public holiday, exchange rates of the previous working day have been disclosed.

Industry and Market Data

Unless stated otherwise, information pertaining to the industry in which our Company operates in, contained in this Red Herring Prospectus is derived from the Technopak Report which has been exclusively commissioned and paid for by our Company, for the purpose of understanding the industry in connection with this Offer, since no report is publicly available which provides a comprehensive industry analysis, particularly for our Company’s services, that may be similar to the Technopak Report. This Red Herring Prospectus contains certain data and statistics from the Technopak Report, which is available on the website of our Company at www.rrkabel.com/industry-research/research.

Industry publications generally state that the information contained in such publications has been obtained from publicly available documents from various sources believed to be reliable but accuracy, completeness and underlying assumptions of such third-party sources are not guaranteed. Although the industry and market data used in this Red Herring Prospectus is reliable, the data used in these sources may have been re-classified by us for the purposes of presentation however, no material data in connection with the Offer has been omitted. Data from these sources may also not be comparable.

Although we believe that the industry and market data used in this Red Herring Prospectus is reliable, industry sources and publications may base their information on estimates and assumptions that may prove to be incorrect. The extent to which the industry and market data presented in this Red Herring Prospectus is meaningful depends upon the reader’s familiarity with, and understanding of, the methodologies used in compiling such information. There are no standard data gathering methodologies in the industry in which our Company conducts business and methodologies and assumptions may vary widely among different market and industry sources. Such information involves risks, uncertainties and numerous assumptions and is subject to change based on various factors.

For details of risks in relation to Technopak Report, see “*Risk Factors – Internal Risk Factors- We have commissioned and paid for a report titled “Consumer Electrical Industry in India” from Technopak Advisors Private Limited, which has been used for industry related data in this Red Herring Prospectus.*” on page 49.

In accordance with the SEBI ICDR Regulations, “*Basis for Offer Price*” beginning on page 120 includes information relating to our peer group companies. Such information has been derived from publicly available sources specified herein. Accordingly, no investment decision should be made solely on the basis of such information.

Notice to Prospective Investors in the United States

The Equity Shares have not been recommended by any U.S. federal or state securities commission or regulatory authority. Furthermore, the foregoing authorities have not confirmed the accuracy or determined the adequacy of this Red Herring Prospectus or approved or disapproved the Equity Shares. Any representation to the contrary is a criminal offence in the United States. In making an investment decision, investors must rely on their own examination of our Company and the terms of this Offer, including the merits and risks involved. The Equity Shares offered in the Offer have not been, and will not be, registered under the U.S. Securities Act and may not be offered or sold within the United States, except pursuant to an exemption from, or in a transaction not subject to, the registration requirements of the U.S. Securities Act and accordingly, the Equity Shares are being offered and sold (i) within the United States solely to persons who are reasonably believed to be “qualified institutional buyers” (as defined in Rule 144A under the U.S. Securities Act) in transactions exempt from the registration requirements of the U.S. Securities Act, and (ii) outside the United States in “offshore transactions” as defined in and in reliance on Regulation S under the U.S. Securities Act and the applicable laws of the jurisdiction where those offers and sales occur.

FORWARD-LOOKING STATEMENTS

This Red Herring Prospectus contains certain “forward-looking statements”. These forward-looking statements generally can be identified by words or phrases such as “aim”, “anticipate”, “are likely”, “believe”, “continue”, “can”, “could”, “expect”, “estimate”, “intend”, “may”, “likely”, “objective”, “plan”, “propose”, “project”, “seek”, “will”, “will achieve”, “will continue”, “will likely”, “will pursue” or other words or phrases of similar import. Similarly, statements that describe our strategies, objectives, plans or goals are also forward-looking statements. All forward-looking statements are subject to risks, uncertainties, expectations and assumptions about us that could cause actual results to differ materially from those contemplated by the relevant forward-looking statement. All statements in this Red Herring Prospectus that are not statements of historical fact are ‘forward-looking statements’.

Actual results may differ materially from those suggested by forward-looking statements due to risks or uncertainties associated with expectations relating to and including, restrictions resulting from the COVID-19 pandemic, regulatory changes pertaining to the industries in India and other overseas jurisdictions in which we operate and our ability to respond to them, our ability to successfully implement our strategy, our growth and expansion, technological changes, our exposure to market risks, general economic and political conditions in India which have an impact on its business activities or investments, the monetary and fiscal policies of India, inflation, deflation, unanticipated turbulence in interest rates, foreign exchange rates, equity prices or other rates or prices, the performance of the financial markets in India and globally, changes in domestic laws, regulations and taxes and changes in competition in the industries in which we operate.

Certain important factors that could cause actual results to differ materially from our expectations include, but are not limited to, the following:

- The costs of the raw materials that we use in our manufacturing process are subject to volatility;
- Any shortages, delay or disruption in the supply of the raw materials we use in our manufacturing process;
- Any disruption, breakdown or shutdown of our manufacturing facilities;
- Any disruption, breakdown or shutdown of our original equipment suppliers; and
- Our inability to maintain the stability of our distribution network in India across our distribution channels and attract additional distributors, dealers and retailers.

For further details regarding factors that could cause actual results to differ from expectations, see “Risk Factors”, “Industry Overview”, “Our Business” and “Management’s Discussion and Analysis of Financial Condition and Results of Operations” beginning on pages 28, 139, 190 and 379, respectively. By their nature, certain market risk disclosures are only estimates and could be materially different from what actually occurs in the future. As a result, actual gains or losses could materially differ from those that have been estimated.

There can be no assurance to Bidders that the expectations reflected in these forward-looking statements will prove to be correct. Given these uncertainties, Bidders are cautioned not to place undue reliance on such forward-looking statements and not to regard such statements to be a guarantee of our future performance.

Forward-looking statements reflect current views of our Company as on the date of this Red Herring Prospectus and are not a guarantee of future performance. These statements are based on our management’s beliefs and assumptions, which in turn are based on currently available information. Although we believe the assumptions upon which these forward-looking statements are based are reasonable, any of these assumptions could prove to be inaccurate, and the forward-looking statements based on these assumptions could be incorrect. Neither our Company, our Directors, the Selling Shareholders, the Syndicate Members nor any of their respective affiliates have any obligation to update or otherwise revise any statements reflecting circumstances arising after the date hereof or to reflect the occurrence of underlying events, even if the underlying assumptions do not come to fruition.

In accordance with the SEBI ICDR Regulations, our Company, will ensure that the Bidders in India are informed of material developments until the time of the grant of listing and trading permission by the Stock Exchanges for the Equity Shares pursuant to the Offer.

In accordance with regulatory requirements including requirements of SEBI and as prescribed under applicable law, the Selling Shareholders, severally and not jointly, (solely to the extent of statements specifically made or confirmed by such Selling Shareholder in relation to its portion of Offered Shares in this RHP) shall ensure that the Company and BRLMs are informed of material developments, in relation to statements and undertakings specifically undertaken or confirmed by them in relation to themselves as Selling Shareholders and the Offered Shares in this Red Herring Prospectus until the time of the grant of listing and trading permission by the Stock Exchanges. Only statements and undertakings which are specifically confirmed or undertaken by the Selling Shareholders in relation to themselves as a Selling Shareholders and the Offered Shares, in this Red Herring Prospectus shall be deemed to be statements and undertakings made by such Selling Shareholders.

SECTION II: RISK FACTORS

An investment in Equity Shares involves a high degree of risk. You should carefully consider all the information in this Red Herring Prospectus, including the risks and uncertainties described below, before making an investment in the Equity Shares. The risks and uncertainties described in this section are not the only risks that we currently face. Additional risks and uncertainties not known to us or that we currently deem immaterial may also have an adverse effect on our business. If any of the following risks, or other risks that are not currently known or are now deemed immaterial, actually occurs, our business, financial condition, results of operations and cash flows could suffer, the price of our Equity Shares could decline, and you may lose all or part of your investment. The financial and other related implications of risks concerned, wherever quantifiable, have been disclosed in the risk factors mentioned below. However, there are risks where the effect is not quantifiable and hence have not been disclosed in the applicable risk factors. Prospective investors should read this section together with “Our Business”, “Industry Overview” and “Management’s Discussions and Analysis of Financial Condition and Results of Operations” beginning on pages 190, 139 and 379, respectively, as well as the other financial and statistical information contained in this Red Herring Prospectus. In making an investment decision, prospective investors should rely on their own examination of us and the terms of the Offer, including the merits and risks involved. You should consult your tax, financial and legal advisors about the particular consequences to you of an investment in our Equity Shares. This Red Herring Prospectus also contains forward-looking statements that involve risks and uncertainties where actual results could materially differ from those anticipated in these forward-looking statements. For further details, see “Forward-Looking Statements” beginning on page 27.

Unless the context requires otherwise, the financial information used in this section is derived from our Restated Consolidated Financial Information.

INTERNAL RISK FACTORS

- The Offer Price, market capitalization to total turnover and price to earnings ratio based on the Offer Price of our Company, may not be indicative of the market price of our Company on listing or thereafter.***

Our revenue from operations and profit for Fiscal 2023 was ₹ 55,992.00 million and ₹ 1,898.72 million, respectively. Our market capitalization to revenue from operations (for Fiscal 2023) multiple is [●] times at the upper end of the Price Band. Our price to earnings ratio (based on our profit for Fiscal 2023) multiple is [●] times at the upper end of the Price Band. The following table sets forth details of our market capitalization to revenue from operations, price to earnings ratio and price to revenue from operations ratio for the periods indicated:

	Market Capitalization to Revenue from Operations	Price to Earnings Ratio	Price to Revenue from Operations Ratio
For Fiscal 2023	[●]	[●]	[●]

The determination of the Offer Price by our Company and the Investor Selling Shareholder, in consultation with the Book Running Lead Managers, is not based on a benchmark with our industry peers. For further details in relation to the comparison with listed industry peers, see “Basis for Offer Price” on page 120. The Offer Price of the Equity Shares is proposed to be determined by our Company and Investor Selling Shareholder in consultation with the Book Running Lead Managers and through the book-building process, and certain quantitative and due to qualitative factors as set out in “Basis for Offer Price” on page 120, the Offer Price, may not be indicative of the market price for the Equity Shares after the Offer.

The price of our Equity Shares upon listing on the Stock Exchanges will be determined by the market and may be influenced by many factors outside of our control. For further details, see “-The Equity Shares have never been publicly traded, and, after the Offer, the Equity Shares may experience price and volume fluctuations, and an active trading market for the Equity Shares may not develop. Further, the price of the Equity Shares may be volatile, and you may be unable to resell the Equity Shares at or above the Offer Price, or at all.” on page 63.

- The costs of the raw materials that we use in our manufacturing process are subject to volatility. Increases or fluctuations in raw material prices may have a material adverse effect on our business, financial condition, results of operations and cash flows.***

Our operations are dependent upon the price and availability of the raw materials that we require for the production of our wires and cables and FMEGs. Our primary raw materials include aluminum, copper, galvanized iron, packing material, low smoke zero halogen compound, master batch, solar cable compound, polyvinyl chloride compound and cross-linked polythene compound. The following table sets forth the details of our total cost of materials and our consumption of copper and aluminum for the periods indicated:

	For Fiscal			For Three Months ended June 30,	
	2021	2022	2023	2022	2023
Cost of Materials Consumed (₹ million)	21,731.99	35,755.15	43,697.88	10,401.30	11,971.13
Cost of Materials Consumed as a	84.71%	86.11%	81.24%	85.36%	79.02%

	For Fiscal			For Three Months ended June 30,	
	2021	2022	2023	2022	2023
Percentage of Total Expenses (%)					
Consumption of Copper and Aluminum (₹ million)	18,390.19	30,052.25	36,007.19	8,612.66	9,902.48
Consumption of Copper and Aluminum as a Percentage of Cost of Materials Consumed (%)	84.62%	84.05%	82.40%	82.80%	82.72%

While we currently manufacture certain raw materials such as polyvinyl chloride compound, low smoke zero halogen compound, cross-linked polythene compound and solar cable compound in-house, we purchase remaining raw materials such as copper and aluminum at market price. For further details in relation to procurement of our raw materials, see “*Our Business – Description of our Business and Operations – Procurement and Raw Materials*” on page 218. The prices of copper and aluminum used in our productions are linked to the prices on the London Metal Exchange.

We have in the past experienced cost fluctuations for these raw materials due to volatility in the commodity markets. Increasing global demand for, and uncertain supply of, any such raw materials could disrupt our or our suppliers’ ability to obtain such materials in a timely manner to meet our supply needs and may lead to increased costs. In case of increase in raw material prices, there can be no assurance that we will be able to pass such cost increases to our customers. Any increase in the cost of inputs to our production could lead to higher costs for our products. If we increase the prices of our products to offset the impact of higher costs, this may cause certain of our customers to cancel orders or refrain from purchasing our products, which may materially and adversely reduce the demand for our products, and thus, negatively impact our operating results. If we are unable to pass on cost increases to our customers or are unsuccessful in managing the effects of raw material price fluctuations, our business, financial condition, results of operations and cash flows could be materially and adversely affected. For further details, see “*Management’s Discussion and Analysis of Financial Condition and Results of Operations- Significant Factors Affecting our Results of Operations – Cost and Availability of Raw Materials*” on page 382.

The prices and supply of these raw materials are also affected by, among others, general economic conditions, competition, production costs and levels, the occurrence of pandemic (such as COVID-19), transportation costs, indirect taxes and import duties, tariffs and currency exchange rate.

3. ***Any shortages, delay or disruption in the supply of the raw materials we use in our manufacturing process may have a material adverse effect on our business, financial condition, results of operations and cash flows.***

We usually keep 20 - 25 days of inventory of raw materials and work-in-progress goods at our facilities. While we strive to maintain adequate inventory levels, we have experienced instances of shortages in a limited manner. In Fiscal 2022, as a result of supply chain disruption caused by COVID-19, we experienced shortages and difficulties in sourcing polyvinyl chloride resin, which is a type of raw material used in the production of our wires and cables. Three shipments of PVC resin totaling 500 metric tonnes were delayed for approximately 50 days. We eventually purchased the polyvinyl chloride resin needed for our production from local suppliers at higher costs. However, if we face a shortage in raw materials in the future, there can be no assurance that we may be able to acquire the raw materials from the market in a timely manner, or at all, and if we are not able to procure raw materials in sufficient quantities, we may not be able to manufacture our products according to our pre-determined timeframes or as contracted with our customers, at our previously estimated product costs, or at all. Therefore, any shortage, delay or disruption in supply of any of our raw materials could have an adverse effect on our business, results of operations, cash flows and reputation. For further details, see “*Management’s Discussion and Analysis of Financial Condition and Results of Operations- Significant Factors Affecting our Results of Operations – Cost and Availability of Raw Materials*” beginning on page 382.

4. ***Any disruption, breakdown or shutdown of our manufacturing facilities may have a material adverse effect on our business, financial condition, results of operations and cash flows.***

We have five manufacturing facilities which are located at Waghodia, Gujarat (“**Waghodia Facility**”), Silvassa, Dadra and Nagar Haveli and Daman and Diu (“**Silvassa Facility**”), Roorkee, Uttarakhand (“**Roorkee Facility**”), Bengaluru, Karnataka (“**Bengaluru Facility**”) and Gagret, Himachal Pradesh (“**Gagret Facility**”) in India. We are dependent on our manufacturing facilities for the production of all of our wires and cables and approximately 37% of our fast moving electrical goods products (by value). During Fiscals 2021, 2022 and 2023, and three months ended June 30, 2022 and June 30, 2023, our total purchases of stock-in-trade amounted to ₹1,298.64 million, ₹1,566.17 million, ₹3,688.53 million, ₹964.38 million and ₹923.35 million, representing 5.06%, 3.77%, 6.86%, 7.91% and 6.10% of our total

expenses in each respective period. Our manufacturing facilities are concentrated in West and North India and events impacting those geographical areas may disrupt our production and operations. Further, our manufacturing facilities are subject to operating risks, such as the breakdown or failure of equipment, disruption in power supply or processes, severe weather conditions, performance below expected levels of efficiency, obsolescence, labor disputes, natural disasters, industrial accidents, infectious diseases (such as COVID-19 pandemic), political instability, the need to comply with the directives of relevant government authorities and the requirement to obtain certain material approvals to operate our manufacturing facilities. We temporarily closed all of our manufacturing facilities in April 2020 for a month to comply with quarantine measures / stay-home orders issued by the government to contain the spread of COVID-19, and briefly closed our manufacturing facilities in March and April 2021 for the same reason. The temporary closure of our facilities reduced our production outputs, delayed our production schedule and negatively impacted our revenue and results of operations for Fiscal 2021. For further details in relation to the impact of the COVID-19 pandemic on our operations, see “-The COVID-19 pandemic has had a material and adverse impact on our business and operations, and it may continue to have an adverse effect on our business prospects and future financial performance” on page 58.

The following table sets forth the installed production capacity and the capacity utilization rate at our manufacturing facilities for Fiscals 2021, 2022 and 2023 and three months ended June 30, 2022 and June 30, 2023. The capacity utilization of our units in Fiscal 2021 reflects the impact of the temporary closures during that period.

Facility	Products	Unit of measurement	Fiscal 2021		Fiscal 2022		Fiscal 2023		Three months ended June 30, 2022		Three months ended June 30, 2023	
			Installed production capacity	Capacity utilization (%)	Installed production capacity	Capacity utilization (%)	Installed production capacity	Capacity utilization (%)	Installed production capacity	Capacity utilization (%)	Installed production capacity	Capacity utilization (%)
Waghodia Facility	Wires and cables – copper and aluminum	CKM	1,349,850	55%	1,719,300	62%	2,116,620	62%	490,710	61%	563,230	69%
	Various types of compounds#	Mts	25,300	64%	39,950	55%	40,400	63%	10,050	59%	10,200	73%
	Switch	Numbers	900,000	17%	5,683,000	59%	8,925,000	81%	2,372,700	98%	2,498,400	83%
Silvassa Facility	Wires and cables	CKM	1,941,000	61%	1,941,000	67%	1,936,000	87%	485,042	63%	484,000	72%
	Various types of compounds#	Mts	13,200	65%	13,200	75%	13,200	86%	3,300	86%	3,300	86%
Roorkee Facility	Fan	Numbers	1,500,000	29%	1,500,000	35%	1,500,000	50%	375,000	54%	375,000	63%
	Light	Numbers	5,512,500	62%	3,900,000	42%	1,800,000	32%	450,000	35%	450,000	18%
Gagret Facility*	Fan	Number	-*	-*	-*	-*	1,650,000	42%	412,500	42%	412,500	54%
Bangalore	Light	Numbers	132,096	50%	121,088	81%	132,096	81%	30,272	76%	33,024	79%

#Various types of compounds includes polyvinyl chloride compound, low smoke zero halogen compound, cross-linked polythene compound and solar cable compound.

*We acquired Gagret Facility during Fiscal 2023. Capacity of Gagret factory considered from May 1, 2022.

Our customers rely significantly on the timely delivery of our products and our ability to provide an uninterrupted supply of our products is critical to our business. While we seek to ensure a continuous supply of our products to our customers, our customer relationships, business and financial results may be adversely affected by any disruption of operations of our product lines and our original equipment manufacturers, due to any of the factors mentioned above.

5. ***We will not receive any proceeds from the Offer for Sale portion and objects of the Fresh Issue for which the funds are being raised have not been appraised by any bank or financial institutions. Any variation in the utilization of our Net Proceeds as disclosed in this Red Herring Prospectus would be subject to certain compliance requirements, including prior Shareholders' approval.***

The Offer includes an offer for sale of up to 17,236,808 Equity Shares by the Selling Shareholders. The proceeds from the Offer for Sale will be paid to the Selling Shareholders and we will not receive any such proceeds. We propose to use the Net Proceeds for repayment or prepayment, in part or full, of certain borrowings availed by our Company and for general corporate purposes. The proposed deployment of Net Proceeds has not been appraised by any bank or financial institution or other independent agency and is based on internal management estimates based on current market conditions and historic level of expenditures. Any variation in the utilization of the Net Proceeds shall be on account of a variety of factors such as our financial condition, business and strategy and external factors such as market conditions and competitive environment, which may not be within the control of our management, and may be subject to various other approvals, which includes, amongst others obtaining prior approval of the Shareholders of the Company. The Offer expenses are estimated to be approximately ₹[●] million. For details, see “*Objects of the Offer*” on page 120.

Various risks and uncertainties, including those set forth in this “*Risk Factors*” section, may limit or delay our efforts to use the Net Proceeds to achieve profitable growth in our business. Accordingly, the use of the Net Proceeds to fund our growth and for other purposes identified by our management may not result in actual growth of our business, increased profitability or an increase in the value of our business and your investment.

6. ***Any disruption, breakdown or shutdown of our original equipment suppliers may have a material adverse effect on our manufacturing capabilities and in turn our business, financial condition, results of operations and cash flows.***

We are dependent on our manufacturing facilities for the production of all of our wires and cables and approximately 37% of our fast moving electrical goods products (by value). We source supplies from more than 25 original equipment manufacturers for 63% of our fast moving electrical goods products, including wiring devices, switches, switchgear, wiring accessories, fans, and certain of our professional and trade lighting products. During Fiscals 2021, 2022 and 2023, and three months ended June 30, 2022 and June 30, 2023, our total purchases of stock-in-trade amounted to ₹1,298.64 million, ₹1,566.17 million, ₹3,688.53 million, ₹964.38 million and ₹923.35 million, representing 5.06%, 3.77%, 6.86%, 7.91% and 6.10% of our total expenses in each respective period. Our original equipment suppliers are subject to operating risks, such as the breakdown or failure of equipment, disruption in power supply or processes, severe weather conditions, performance below expected levels of efficiency, obsolescence, labor disputes, natural disasters, industrial accidents, infectious diseases (such as COVID-19 pandemic), political instability, the need to comply with the directives of relevant government authorities and the requirement to obtain certain material approvals to operate our manufacturing facilities. Our original equipment manufacturer suppliers had to shut down their operations during April 2020 and March and April 2021 to comply with quarantine measures / stay-home orders issued by the government to contain the spread of COVID-19. Any disruption in original equipment manufacturers' manufacturing processes could disrupt our manufacturing schedules, if we are unable to find a suitable replacement in a timely manner, or at all. This may further have a material adverse effect on our business, financial condition, results of operations and cash flows.

7. ***Our inability to maintain the stability of our distribution network in India across our distribution channels and attract additional distributors, dealers and retailers may have a material adverse effect on our results of operations and financial condition.***

We rely on our extensive pan-India distribution network of dealers, distributors and retailers to sell our products in India. As at June 30, 2023, we have 3,450 distributors, 3,656 dealers and 114,851 retailers in our pan-India distribution network. We also have a presence on recognized e-commerce platforms.

We sell our products through memoranda of understanding (“**MoUs**”) with distributors and certain customers within India and across the rest of the world, on a non-exclusive basis. Most of the MoUs with our customers in the business-to-business channel have a term of approximately one year. These MoUs may be renewed or extended in accordance with the terms of such MoUs. Our contractual arrangements with our dealers and remaining customers are predominantly purchase orders. Further, we issue purchase order to our international shipping agents at each time their services are required. There can be no assurance that we can continue to maintain our networks of distributors, dealers, retailers and international shipping agents on commercially favorable terms or at all. Any failure to enter into new and similar agreements on commercially acceptable terms or at all, or any conduct of operations with distributors and customers without entering into a MOU, could have a material adverse effect on our business, financial condition, prospects, results of operations or cash flows.

The success of our business depends on maintaining good relationships with distributors, dealers and retailers, and ensuring that these distributors, dealers and retailers find our products to be commercially remunerative and have continuing demand from customers. In addition, our growth as a business depends on our ability to attract additional distributors, dealers and retailers to our distribution network. As at the date of this Red Herring Prospectus, we do not have any arrangements with distributors, dealers and retailers which requires them to exclusively sell our products. To incentivize such distributors, dealers and retailers, we offer them discounts on purchase price of our products based on their sales level within a particular period. We have no control over our competitors who may offer greater incentives to such distributors, dealers and retailers. Furthermore, we have limited ability to manage the activities of independent third party distributors and we cannot assure you that they will, at all times, strictly adhere to the terms and conditions of our arrangements with them. In addition, if the distributors violate applicable laws or otherwise engage in illegal practices with respect to their sale and marketing of our products, our brand and reputation may be adversely affected. There can be no assurance that our current distributors, dealers and retailers will continue to do business with us, or that we can continue to attract additional distributors, dealers and retailers to our network.

Further, as we grow our e-commerce presence, the control that e-commerce platforms have over the access, fee structures and/or pricing for products on their platforms could impact the volume of purchases of our products made on their platform and our revenues from such e-commerce platforms. In Fiscals 2023 and three months ended June 30, 2022 and June 30, 2023, our revenue from e-commerce platform dealers amounted to ₹135.13 million, ₹27.37 million and ₹91.33 million, representing 0.24%, 0.22% and 0.57%, respectively, of our revenue from operations. We did not derive any revenue from e-commerce platforms in Fiscals 2021 and 2022. If such e-commerce platforms establish terms that are adverse to the sales of our products on their platform, significantly impact the financial terms on which such products are offered, or do not approve the inclusion of our products on their platform, our e-commerce business could be negatively impacted. If we fail to maintain the stability of our distribution network across distribution channel and attract additional distributors, dealers and retailers to our distribution network, our sales and market share may decline which would have a material adverse impact on our business, financial condition, results of operations and cash flows.

8. ***Our distribution to the overseas market is dependent on a few distributors and significant changes to our business arrangements with these distributors may impact our results of operations, cash flows and financial condition.***

For Fiscals 2021, 2022 and 2023 and three months ended June 30, 2022 and June 30, 2023, our revenue from outside India amounted to ₹5,867.66 million, ₹10,075.54 million, ₹12,701.90 million, ₹3,436.30 million, and ₹4,303.73 million, representing 21.54%, 22.97%, 22.69%, 27.80% and 26.94%, respectively, of our revenue from operations, as per our segment reporting under Ind AS 108. As of June 30, 2023, we have relationships with 72 distributors in our distribution channel to our overseas markets, namely, North America, Asia Pacific, Europe and Middle East. Additionally, we depend on our network of shipping agents for, *inter alia*, cargo handling, transportation, delivery at the destination and load port for export cargo and import cargo. We are exposed to the concentration risk of relying on a few distributors for our distribution to the overseas markets. In Fiscals 2021, 2022 and 2023, and three months ended June 30, 2022 and June 30, 2023, our top ten overseas distributors accounted for ₹5,454.25 million, ₹9,337.19 million, ₹11,406.64 million, ₹3,061.88 million, and ₹4,234.63 million, representing 92.95%, 92.67%, 89.81%, 89.10% and 98.39% of our revenue from operations from outside India. There can be no assurance that we can continue to enter into distribution agreement with our material overseas distributors on commercially favorable terms or at all. Any termination with our material overseas distributors could have a material adverse effect on our business, financial condition, prospects, results of operations or cash flows.

9. ***We are dependent on the performance of the wires and cables market. Any adverse changes in the conditions affecting the wires and cables market can adversely impact our business, financial condition, results of operations, cash flows and prospects.***

We derive most of our revenue from operations from the manufacture and supply of wires and cables. For Fiscals 2021, 2022 and 2023 and three months ended June 30, 2022 and June 30, 2023, revenue from operations from our wires and cables segment amounted to ₹25,202.47 million, ₹41,112.71 million, ₹49,585.32 million, ₹11,058.27 million and ₹14,230.82 million, which accounted for 92.52%, 93.74%, 88.56%, 89.47% and 89.09%, respectively of our total revenue from operations in such periods. As a result, our business and financial condition is heavily dependent on the performance of the wires and cables market globally and in India, and we are exposed to fluctuations in the performance of these markets. In Fiscal 2021, as a result of reduced economic activities arising from the general impact of COVID-19, we experienced reduced demands for wires and cables, which negatively impacted our revenue and our results of operation in Fiscal 2021. If demand for wires and cables in India or abroad decreases in the future, our business, results of operations, financial condition, cash flows and prospects may be materially and adversely affected.

The wires and cables market may be affected by, among others, changes in government policies, government initiatives, economic conditions, income levels and interest rates, which may negatively affect the demand for and the valuation of our products. These and other factors may negatively contribute to changes in the prices of and demand for our wires and cables and may have a material adverse effect on our business, financial condition, results of operations and cash flows.

10. ***We are exposed to risks arising from credit terms extended to our customers comprising distributors, dealers, retailers and end users.***

Due to the nature of, and the inherent risks in, the agreements and arrangements with distributors, dealers, retailers and end users, we are subject to counterparty credit risk and any delay in receiving payments or non-receipt of payments may adversely impact our results of operations and cash flows. As at March 31, 2021, 2022 and 2023 and June 30, 2022 and June 30, 2023, our trade receivables were ₹4,203.64 million, ₹5,171.46 million, ₹5,918.73 million, ₹5,384.47 million and ₹6,315.23 million, respectively. The following table sets forth the total allowance for expected credit loss on trade receivables as at and for the year/period indicated:

(in ₹ million)

Fiscal 2021		Fiscal 2022		Fiscal 2023		For three months ended June 30, 2022		For three months ended June 30, 2023	
As at March 31, 2021 - Total allowance for expected credit loss	For the year ended March 31, 2021 - Allowance for / (Reversal) of expected credit loss charged to restated consolidated statement of profit and loss	As at March 31, 2022 - Total allowance for expected credit loss	For the year ended March 31, 2022 - Allowance for / (Reversal) of expected credit loss charged to restated consolidated statement of profit and loss	As at March 31, 2023 - Total allowance for expected credit loss	For the year ended March 31, 2023 - Allowance for / (Reversal) of expected credit loss charged to restated consolidated statement of profit and loss	As at June 30, 2022 - Total allowance for expected credit loss	For three months ended June 30, 2022 - Allowance for / (Reversal) of expected credit loss charged to restated consolidated statement of profit and loss	As at June 30, 2023 - Total allowance for expected credit loss	For three months ended June 30, 2023 - Allowance for / (Reversal) of expected credit loss charged to restated consolidated statement of profit and loss
360.10	52.91	342.03	(18.07)	347.42	5.39	333.12	(8.91)	350.32	2.90

There is no assurance that we will accurately assess the creditworthiness of our direct customers, distributors, dealers and retailers. Macroeconomic conditions, such as a potential credit crisis in the global financial system, could also result in financial difficulties for our customers, distributors, dealers and retailers, including limited access to the credit markets, insolvency or bankruptcy. Such conditions could cause them to delay payment, request modifications of their payment terms, default on their payment obligations to us, or default their payment obligations under channel financing facilities to financial institutions, all of which could increase our receivables or our liabilities. Timely collection of dues from end users, distributors, dealers and retailers also depends on our ability to complete our contractual commitments and subsequently bill for and collect from them. If we are unable to meet our contractual obligations, we might experience delays in the collection of, or be unable to collect, our balances and our results of operations and cash flows could be adversely affected. In addition, if we experience delays in billing and collection for our services, our cash flows could be adversely affected.

11. ***If we are unable to maintain and enhance our brands, including our ability to protect our brand through intellectual property, the sales of our products will suffer, which would have a material adverse effect on our results of operations. We may also unintentionally infringe upon the intellectual property rights of others, any misappropriation of which could harm our competitive position.***

We believe that our brands plays a significant role in the success of our business and sustaining customer loyalty. The ability to differentiate our brands and products from that of our competitors through our promotional, marketing and advertising initiatives is an important factor in attracting customers. As of the date of this Red Herring Prospectus, we have 228 registered trademarks. Further, pursuant to a trademark license agreement dated April 29, 2015, as amended pursuant to an amendment to the trademark license agreement dated August 10, 2018, entered into with Ram Ratna Research and Holdings Private Limited, we have been granted a non-exclusive license to use certain trademarks,

namely ‘RR’, ‘RR✓’ and  for a period of 14 years from April 29, 2015. Additionally, we have the right to use 61 registered trademarks, five applications for trademark registrations and 18 trademarks not yet applied to be registered with Trade Marks Registry for an initial period of two years subject to extension of six months at a time for a maximum of four times, in relation to the licensed ‘Luminous Fans and Lights’ brand pursuant to the brand license agreement dated May 1, 2022 with Luminous Power Technologies Private Limited. For details, see “Our Business – Intellectual Property” on page 219. There can be no assurance that our brand name or the licensed ‘Luminous Fans and Lights’ or ‘RR’ trademarks will not be adversely affected in the future by actions that are beyond our control

including customer complaints, intellectual property infringements or adverse publicity from any other source in India and abroad. Any damage to our brand name, if not immediately and sufficiently remedied, could have an adverse effect on our reputation, competitive position in India and abroad, business, financial condition, results of operations and cash flows.

The application of laws governing intellectual property rights in India is uncertain, evolving and could involve substantial risks to us. Failure to register or renew the registration of any of our registered intellectual properties may affect our right to use such intellectual properties in future or allow others to use our products and designs as available in the public domain, without our consent. Further, if we are unable to register our intellectual properties for any reason, including our inability to remove objections to any trademark application, or if any of our unregistered trademarks are registered in favor of or used by a third party in India or abroad, we may not be able to claim registered ownership of such trademark, and as a result, we may not be able to seek remedies for infringement of those trademarks by third parties, which would cause damage to our business prospects, reputation and goodwill in India and abroad. For instance, as of June 30, 2023, 9 trademarks in relation to our RR Kabel brand have been opposed. We cannot assure you that there will not be similar instances where our applications for trademarks may be opposed, which may have a material adverse effect to our business.

While we take care to ensure that we comply with the intellectual property rights of others, we cannot determine with certainty whether we are infringing any existing third-party intellectual property rights which may force us to alter our brand offerings. We may also be susceptible to claims from third parties asserting infringement and other related claims. If claims or actions are adjudicated against us from third parties asserting infringement and other related claims in India and abroad, we may be required to obtain a license, modify our existing technology or cease the use of such technology and design, or use a new non-infringing technology. Such licenses or design modifications can be extremely costly. Further, necessary licenses may not be available to us on satisfactory terms, if at all. In addition, we may decide to settle a claim or action against us, the settlement of which could be costly and time consuming. We may also be liable for any past infringement. Any of the foregoing could adversely affect our business, financial condition, results of operations and cash flows.

12. ***The availability of counterfeit products, such as products passed off as our products by others, and any failure to protect or enforce our rights to own or use trademarks and brand name and identity could have an adverse effect on our business and competitive position.***

Our efforts to protect our brand name and our intellectual properties may not be adequate, and our operations could be adversely affected. In particular, third parties could imitate our brand name or pass off their own products as ours, including registering trademarks that may be confused with ours, producing copycat products or counterfeit or pirated products. As a result, our market share could be reduced due to replacement of demand for our products and deficiency in the quality of the copycat or counterfeit products will adversely affect our goodwill and brand reputation. We may also have to incur significant costs to remedy or manage such situations. In addition, even though we require our original equipment manufacturers to maintain manufacturing standards similar to ours and we conduct quality checks on products sourced from original equipment manufacturers, we may also suffer reputational damages if there is any quality deficiency or defect in our fast moving electrical good products supplied by our original equipment manufacturers that we fail to detect in our quality control process. Any impact on our ability to continue to promote our brand or any significant damage to our brand's image could materially and adversely affect our sales and profits.

During the past three years prior to the date of this Red Herring Prospectus, we have been made aware of several incidents of sales of counterfeit products in India. We have engaged security contractors to trace and locate counterfeit products and vendors who produce and/or sell our counterfeit products across India. Once we have gathered sufficient information and evidence, we request the local police force to seize the counterfeit products. From Fiscals 2021 to three months ended June 30, 2023, the local police, with our assistance, made 36 raids on vendors of counterfeit products. For instance, on March 13, 2023, 600 duplicate electric wire boxes of our "RR Kabel" brand were seized in Madurai, Tamil Nadu, and on April 30, 2022, 68 rolls of duplicate closed circuit television cable wires of our "RR Kabel" brand were seized in Noida, Uttar Pradesh. While such incidents of counterfeit products have not had a material adverse effect on our goodwill and results of operations, there can be no assurance that the proliferation of counterfeit and pirated products in the future, and the time and attention lost to defending such claims and complaints regarding counterfeit products would not have a material adverse effect on our goodwill and our business, prospects, financial condition, results of operations and cash flows.

Maintaining and enhancing our brand image may also require us to undertake significant expenditures and make investments in areas such as research and development, advertising and marketing, through local engagement, digital media and other channels of publicity, intellectual property development, registration, compliance monitoring and enforcement and towards employee development and training. If our initiatives in any of these areas are not effectively implemented or our products fail to find acceptance with our existing and potential customers resulting in loss of customer confidence in our brand for any reason, our ability to attract and retain customers could be adversely affected.

Further, if we fail to maintain our brand name and identity, which we believe is one of the principal factors that differentiates us from our competitors, we may not be able to maintain our competitive edge. If we are unable to compete successfully, we could lose our customers, which would negatively affect our financial performance and

profitability. Moreover, our ability to protect, enforce or utilize our brand name is subject to risks including general litigation risks.

13. ***Our inability to handle risks associated with our export sales could negatively affect our sales to customers in foreign countries, as well as our operations and assets in such countries, and our overall profitability.***

During Fiscals 2021 to 2023 and three months ended June 30, 2023, we exported our products to 63 countries across North America, Asia Pacific, Europe and Middle East. For Fiscals 2021, 2022 and 2023 and three months ended June 30, 2022 and June 30, 2023, our revenue from outside India amounted to ₹5,867.66 million, ₹10,075.54 million, ₹12,701.90 million, ₹3,436.30 million, and ₹4,303.73 million, representing 21.54%, 22.97%, 22.69%, 27.80% and 26.94%, respectively, of our revenue from operations, as per our segment reporting under Ind AS 108. The following table sets forth the revenue derived from exports to the top ten countries, for the periods indicated:

(in ₹ million)

	For Fiscal			For Three Months ended June 30,	
	2021	2022	2023	2022	2023
United Arab Emirates	1,793.07	3,252.49	3,821.30	986.09	1,457.37
United Kingdom	1,873.05	3,086.36	3,095.00	799.76	1,169.65
Myanmar	961.19	668.92	1,134.47	292.83	94.69
United States of America	303.04	1,043.37	1,002.84	339.91	498.70
Austria	162.51	554.98	981.42	352.49	-
Mauritius	70.74	203.93	224.18	65.77	144.07
Slovenia	-	-	378.21	-	413.32
New Zealand	84.86	210.46	238.94	87.41	78.46
Belgium	119.15	200.46	177.95	21.83	33.49
Australia	76.23	208.01	164.45	36.84	23.59
Total	5,443.84	9,428.97	11,218.77	2,982.92	3,913.33

Our international operations are subject to risks that are specific to each country and region in which we operate, as well as risks associated with international operations in general. Our international operations are subject to, among other risks and uncertainties, the following:

- demand for our products by our customers located outside India;
- social, economic, political, geopolitical conditions and adverse weather conditions, such as natural disasters, civil disturbance, terrorist attacks, war or other military action would affect our business and operations and may also prevent us from production or delivery of our products to our customers;
- compliance with local laws, including legal constraints on ownership and corporate structure, environmental, health, safety, labor and accounting laws, may impose onerous and expensive obligations on our foreign subsidiaries. If we are unable to comply with such laws, our business, results of operations, financial condition and cash flows could be adversely affected;
- changes in foreign laws, regulations and policies, including restrictions on trade, import and export license requirements, and tariffs and taxes, intellectual property enforcement issues and changes in foreign trade and investment policies, may affect our ability to both operate and the way in which we manage our business in the countries in which we operate;
- fluctuations in foreign currency exchange rates against the Indian Rupee, may affect our results of operations, the value of our foreign assets, such as export receivables, the relative prices at which we and our competitors sell products in the same markets and the cost of certain inventory and non-inventory items required for our operations. For instance, fluctuation of the Pound Sterling, Euro and U.S. Dollar would have an impact on the export revenues and profits of our operations;
- anti-competitive behavior, money laundering, bribery and corruption by third parties as well as crime and fraud; and
- inability to effectively enforce contractual or legal rights and adverse tax consequences; differing accounting standards and interpretations.

In addition, we may not perform as expected in our international markets, because our competitors and the established players in these markets may have a more established presence and have more experience in operating in such market, which could allow them to have better relationships with distributors and consumers, gain early access to information regarding attractive sales opportunities and, in general, be better placed to launch products with other advantages of being a first mover. For further details in relation to our quality control steps, see “*Our Business – Description of our Business and Operations – Quality control, process safety and regulatory inspections*” on page 220.

Any of these risks could have a material adverse effect on our business, financial condition, results of operations, cash flows and prospects.

14. ***We are exposed to foreign currency fluctuation risks, particularly in relation to import of raw materials, export of products and our borrowings, which may adversely affect our results of operations, financial condition and cash flows.***

We present our financial statements in Indian Rupees. However, given that we export our products to 63 countries as on June 30, 2023, a portion of our business transactions is denominated in foreign currencies. Our revenue from operations from outside India geographical segment, as per Ind AS 108, constituted 21.54%, 22.97%, 22.69%, 27.80% and 26.94% of our revenue from operations in Fiscals 2021, 2022 and 2023 and three months ended June 30, 2022 and June 30, 2023, respectively. Further, our raw materials such as aluminium and copper are priced by reference to benchmarks quoted in US dollars, and hence our expenditures are largely influenced by the value of the US dollar. For details on the exchange rates between the Indian Rupee and the USD, Euro and British Pound, see “*Management’s Discussion and Analysis of Financial Condition and Results of Operations – Significant Factors affecting our Financial Condition and Results of Operations – Fluctuations in Exchange Rates*” and “*Management’s Discussion and Analysis of Financial Condition and Results of Operations- Information about revenue split by geographical area*” on page 382 and 388.

Depreciation of the Indian Rupee against the USD, the Euro, the British Pound and other foreign currencies may adversely affect our results of operations by increasing the cost of the raw materials we import or any proposed capital expenditure in foreign currencies. Although we generally seek to pass exchange rate fluctuations through to our customers through increases in our prices, there can be no assurance that we will be able to do so immediately or fully, which could adversely affect our business, financial condition, results of operations and cash flows.

Further, while we seek to hedge our foreign currency risk by entering into foreign exchange forward contracts, any steps undertaken to hedge the risks due to fluctuations in currencies may not adequately hedge against any losses we incur due to such fluctuations. The following table sets forth details of our foreign currency exposure as at indicated dates:

(in ₹ million, unless specified otherwise)

	As at March 31, 2021	As at March 31, 2022	As at March 31, 2023	As at June 30, 2022	As at June 30, 2023
Foreign currency exposure that is not hedged by derivative instruments or otherwise					
USD	5.03	(0.26)	2.91	(4.14)	4.30
Euro	0.07	0.21	(0.37)	(0.24)	(0.31)
GBP	0.06	0.15	0.01	0.28	0.01
Total foreign currency exposure					
USD	17.26	17.07	15.77	26.30	27.00
Euro	0.69	2.57	6.95	4.13	5.09
GBP	9.16	8.35	13.54	3.64	8.72
Foreign currency exposure that is not hedged by derivative instruments or otherwise as a percentage of Total foreign currency exposure (%)					

	As at March 31, 2021	As at March 31, 2022	As at March 31, 2023	As at June 30, 2022	As at June 30, 2023
USD	29%	-2%	18%	-16%	16%
Euro	10%	8%	-5%	-6%	-6%
GBP	1%	2%	0%	8%	0%

Note: The foreign currency exposure is calculated as export trade receivables less import creditors less buyers' credit.

15. We have significant power and fuel requirements and any disruption to power sources could increase our production costs and adversely affect our results of operations and cash flows.

We require substantial power and fuel for our manufacturing facilities, and our energy costs represent a significant portion of the production costs for our operations. For Fiscals 2021, 2022 and 2023 and three months ended June 30, 2022 and June 30, 2023, our power and fuel expenses were ₹306.62 million, ₹370.24 million, ₹487.93 million, ₹109.05 million and ₹141.91 million, constituting 1.20%, 0.89%, 0.91%, 0.89% and 0.94%, respectively, of our total expenses. If energy costs were to rise, or if electricity supplies or supply arrangements were disrupted, our profitability could decline. Energy prices can be affected by numerous factors beyond our control, including global and regional supply and demand, carbon taxes, inflation, political and economic conditions, and applicable regulatory regime.

We source most of our electricity requirements for our manufacturing facilities from local power suppliers or state electricity boards. If our electricity suppliers increase the price for electricity, our cost of production and profitability would be materially adversely affected. Further, natural disasters or adverse conditions may occur in the geographical areas in which we operate including severe weather, tropical storms, floods, excessive rainfalls as well as other events beyond our control. If for any reason electricity is not available, we may need to shut down our plants until an adequate supply of electricity is restored. Interruptions of electricity supply can also result in production shutdowns, increased costs associated with restarting production and the loss of production in progress.

16. Our success depends on our ability to execute our growth strategies. If we are unable to sustain or manage our growth, our business, results of operations, cash flows and financial condition may be adversely affected

We are embarking on a growth strategy that involves steps aimed at expanding our distribution and establishing leadership position for our wires and cables segment in India, enhancing our geographical footprint of our wires and cables segment, capitalizing on the market opportunity in wires and cables segment, including through innovation and product development to expand our product portfolio, growing and expanding our fast moving electrical good segment organically and inorganically, enhancing productivity and operational efficiencies and enhancing our environmental initiatives. For further details, see “Our Business – Strategies” on page 200. Our future growth depends on our ability to significantly increase both our manufacturing capacity and production output both in our wires and cables business and our fast moving electrical good business in a cost-effective and efficient manner.

Our growth strategy will place significant demands on our management as well as our financial, accounting and operating systems. Our ability to expand our business is subject to significant risks and uncertainties, including the following:

- the need to raise significant additional funds to build an additional manufacturing facility, which we may be unable to obtain on reasonable terms or at all;
- delays and cost overruns as a result of a number of factors, many of which may be beyond our control, such as unavailability of timely supplies of equipment and technologies;
- pandemics or epidemics, such as the COVID-19 pandemic;
- inability to hire, train and retain skilled sales and marketing personnel for the sale and distribution of our products;
- inability to develop and maintain relationships with our customers;
- our dependence on customers from a range of industries such as real estate, infrastructure, automobile, telecommunication, railways, textile, pharmaceutical, paint, cement, and data centers which in turn depend on favorable general macro-economic conditions;
- delays or denial of required approvals by relevant government authorities;
- diversion of significant management attention and other resources;
- inability to derive benefits from product development efforts/ commercialization;

- inadequate infrastructure and logistics for the delivery of our products;
- inability to adapt our operational and management systems to an expanded distribution network;
- the competition we face from other manufacturers, traders, suppliers and importers of wires and cable, and consumer electrical products in relation to our offerings;
- market development of new products taking longer than expected;
- failure of our contractors and suppliers to adhere to our specifications and timelines;
- failure to maintain high quality control standards;
- shortage of raw materials or our inability to source for sufficient inventory; and
- failure to execute our expansion plans effectively.

To achieve and maintain future growth, we need to, among other things, effectively manage our expansion projects, accurately assess new markets, attract new distributors or customers, obtain sufficient financing for our expected capital expenditures, control our input costs, effectively expand, train and manage our employees, maintain sufficient operational and financial controls, acquire businesses that we believe are congruent with our expansion plans and make additional capital investments to take advantage of anticipated market conditions.

Further, our ability to sustain our rates of growth may be affected by external factors outside our control, including a decline in the demand for wires and cables or other consumer electrical products, increased price competition, the lack of availability of raw materials, or a general slowdown in the economy. The consumer electrical market may be affected by, among other things, changes in government policies, government initiatives, economic conditions, income levels and interest rates, which may negatively affect the demand for and the valuation of our products. These factors may negatively contribute to changes in the prices of, and demand for, our wires and cables and fast moving electrical good products, and could contribute to a failure to sustain our growth, which could have a material adverse effect on our business, results of operations, cash flows and financial condition.

17. ***We have utilized channel financing from banks to our customers to facilitate our cash flows and provided guarantees for a portion of the amount owed by our customers to these banks. Any failure of our customers to repay the amounts under these channel financing arrangements may result in us incurring losses and may negatively impact our profitability.***

In recent years, we used channel financing facilities to facilitate our financing needs, whereby our customers enter into arrangements with banks through which we receive payment directly from the banks, who in turn take on credit risk and seek to collect outstanding dues from our customers. As on the date of this Red Herring Prospectus, our Company has not issued any guarantees to third parties that are currently outstanding. However, we typically provide guarantees to the financial institutions for a portion of the amount owed by our customers under the channel financing facilities. If the customer defaults on repayment of the loan extended by the banks, the same is recovered from us pursuant to the guarantee and subject to other terms of the channel financing program. Channel financing reduces our risk of non-payment, and significantly increases the speed at which we receive payment, as we receive payment directly from banks. However, any decrease in the availability of credit to our customers, or banks' willingness to allow our customers to use channel financing, could significantly reduce the speed at which we receive payment, and increase our risk of non-payment. Our inability to obtain funding on reasonable terms, or at all, could affect our ability to manufacture products and would have an adverse effect on our business, results of operations and cash flows. For Fiscals 2021, 2022 and 2023, and three months ended June 30, 2022 and June 30, 2023, ₹1,085.54 million, ₹1,704.37 million, ₹2,557.76 million, ₹1,758.26 million and ₹2,697.80 million, respectively, of our channel financing guarantees have been utilized. Accordingly, for Fiscals 2021, 2022 and 2023, and three months ended June 30, 2022 and June 30, 2023, we disclosed contingency on account of customers defaulting in repayment to the respective banks of ₹546.00 million, ₹425.76 million, ₹225.00 million, ₹225.00 million and ₹225.00 million, respectively (to the extent of recourse available with the banks).

18. ***Our Company has availed unsecured loans from banks and other financial institutions, which may be recalled on demand.***

For Fiscals 2021, 2022 and 2023 and for three months ended June 30, 2022 and June 30, 2023, we have outstanding unsecured working capital loan (excluding interests accrued) amounting to ₹330.55 million, ₹1,192.56 million, ₹864.93 million, ₹1,135.73 million and ₹681.55 million, respectively as unsecured loans from banks and other financial institutions, which are repayable on demand to the relevant lenders. These loans are not repayable in accordance with any agreed repayment schedule and may be recalled by the relevant lender at any time. In such cases, we may be required to repay the entirety of the unsecured loans together with accrued interest. We may not be able to generate sufficient funds at short notice to be able to repay such loans and may resort to refinancing such loans at a higher rate of interest and on terms not favorable to it. Failure to repay unsecured loans in a timely manner may have a material

adverse effect on our business, results of operation financial condition and cash flow. For further details of our unsecured loans, please refer the section titled “*Financial Information*” beginning on page 269 of this Red Herring Prospectus.

19. ***Our insurance coverage may not be adequate to protect us against all potential losses, which may have a material adverse effect on our business, financial condition, cash flows and results of operations.***

Our operations are subject to various risks and hazards inherent in the manufacturing business, including breakdowns, failure or substandard performance of equipment, third party liability claims, labor disturbances, employee fraud and infrastructure failure, as well as fire, theft, robbery, earthquake, flood, acts of terrorism and other force majeure events. We have obtained insurance policies in relation to plant and machinery, burglary, stocks and finished goods. In addition, we have also obtained directors’ and officers’ liability insurance. The following table sets forth details of our insurance coverage as on March 31, 2021, March 31, 2022, March 31, 2023 and June 30, 2023:

(in ₹ million, unless specified otherwise)

	As on March 31, 2021		As on March 31, 2022		As on March 31, 2023		As on June 30, 2023	
	Insured Tangible Assets	Uninsured / Under-insured Tangible Assets	Insured Tangible Assets	Uninsured / Under-insured Tangible Assets	Insured Tangible Assets	Uninsured / Under-insured Tangible Assets	Insured Tangible Assets	Uninsured / Under-insured Tangible Assets
Amount of Tangible Assets*	5,348.28	74.54	5,638.95	118.49	6,644.65	160.29	6,850.84	51.51
Amount of Insurance Obtained	5,500.09	-	6,201.58	-	6,874.23	-	7,359.59	-
% of Total Tangible Assets	98.63%	1.37%	97.94%	2.06%	97.64%	2.36%	99.25%	0.75%
Insurance Coverage	102.84%	-	109.98%	-	103.46%	-	107.43%	-

* Tangible Assets value reported at gross value, excluding details of vehicles which is approximately 2.94% of total tangible assets of our Company (in value terms) as on June 30, 2023.

* Amount (in ₹ million) denotes Gross value of assets, not written down value

There are possible losses, which we may not have insured against or covered or wherein the insurance cover in relation to the same may not be adequate. If we were to incur a serious uninsured loss or a loss that significantly exceeds the limits of our insurance policies, it could have a material adverse effect on our business, financial condition, results of operations and cash flows. For details, see “*Our Business – Insurance*” on page 225.

Our policies are subject to standard limitations that apply to the length of the interruption covered and the maximum amount that can be claimed. Therefore, insurance might not necessarily cover all losses incurred by us and we cannot provide any assurance that we will not incur losses or suffer claims beyond the limits of, or outside the relevant coverage of, insurance policies. We cannot assure you that the operation of our business will not be affected by any of the risks and hazards listed above. In addition, our insurance may not provide adequate coverage in certain circumstances including losses arising due to third-party claims that are either not covered by insurance or the values of which exceed insurance limits, economic or consequential damages that are outside the scope of insurance coverage and claims that are excluded from coverage. If our arrangements for insurance are not adequate to cover claims, we may be required to make substantial payments and our results of operations, financial condition and cash flows may therefore be adversely affected.

We may not have identified every risk, and further may not be insured against every risk, including operational risks that may occur, and the occurrence of an event that causes losses more than the limits specified in our policies, or losses arising from events or risks not covered by insurance policies or due to the same being inadequate. Any of the above could materially harm our financial condition and future results of operations and cash flows. There can be no assurance that any claims filed will be honored fully or in a timely fashion under our insurance policies. In addition, we may not be able to renew certain of our insurance policies upon their expiration, either on commercially acceptable terms or at all.

20. ***We have had negative cash flows in prior periods and may continue to have negative cash flows in the future.***

We experienced the cash flows, both positive and negative, set forth in the table below for the specified periods:

	Fiscal 2021	Fiscal 2022	Fiscal 2023	Three months ended June 30, 2022	Three months ended June 30, 2023
	(₹ in million)				
Net cash generated from / (used in) operating activities	(710.57)	981.70	4,537.46	1,476.60	777.27
Net cash generated / (used in) investing activities	(58.80)	(626.55)	(3,334.97)	(1,257.82)	346.76

	Fiscal 2021	Fiscal 2022	Fiscal 2023	Three months ended June 30, 2022	Three months ended June 30, 2023
(₹ in million)					
Net cash (used in) / generated from financing activities	741.25	(316.11)	(1,015.14)	(274.71)	(1,282.97)
Net increase/(decrease) in cash and cash equivalents	(28.12)	39.04	187.35	(55.93)	(158.94)

Such negative cash flows from operating activities for Fiscal 2021 was mainly attributable to changes in working capital consisting of increases in inventories, decrease in trade payables and increase in other current assets. Negative cash flows from investing activities for Fiscal 2021 was mainly attributable to purchase of property, plant and equipment (including capital work-in-progress, capital advances, capital creditors and net off proceeds from sale of property, plant and equipment).

Negative operating cash flows over extended periods, or significant negative cash flows in the short term, could materially impact our ability to operate our business and implement our growth plans. As a result, our cash flows, business, future financial performance and results of operations could be materially and adversely affected. For further details, see “*Management’s Discussion and Analysis of Financial Condition and Results of Operations - Cash flows and cash and cash equivalents*” on page 395.

21. ***We have pursued inorganic growth opportunities in the past to grow our FMEG business. We may face difficulties integrating acquired businesses and brands, which may result in incurring significant costs and impact our business, results of operations and profitability.***

In our fast moving electrical good segment, in addition to expanding our production capacity organically, we have also made certain acquisitions in recent years. In Fiscal 2020, we acquired the light emitting diode lights and related hardware business of Arraystorm Lighting Private Limited, along with its trademarks and design certificates (other than ‘Ethos’, ‘Adappt’ and ‘WIoT’ trademarks), to expand our portfolio to cover office, industrial and warehouse spaces. In May 2022, we acquired the home electrical business of Luminous Power Technologies Private Limited, along with its trademarks and design certificates, to strengthen our fast moving electrical goods portfolio. Further, we have been granted a limited, exclusive, non-transferable, non-assignable and non-delegable license to use the ‘Luminous Fans and Lights’ brand for fan and light products for an initial period of two years subject to extension of six months at a time for a maximum of four times, that includes the right to use 61 registered trademarks, five applications for trademark registrations and 18 trademarks not yet applied to be registered with Trade Marks Registry. In terms of the brand license agreement, out of which we paid a lump sum amount of ₹50.00 million as royalty for use of the licensed brands in the first two years. Further, we need to pay royalty of ₹50.00 million for any extension of the brand license agreement on a semi-annual basis for the remaining two years to use the licensed brands. We also have a one time right to extend the license for a period of three months and have to pay ₹25.00 million as royalty for such extension. We have adopted ‘Luminous Fans and Lights’ brand for our premium fast moving electrical good products and subsequently, aim to develop and establish ‘RR Signature’ brand for our premium fast moving electrical good products in replacement of the ‘Luminous Fans and Lights’ brand over time through Fiscal 2024.

The home electrical business of Luminous Power Technologies Private Limited had incurred operating losses in the past prior to our acquisition thereof. The consideration we paid for the acquisition of the home electrical business was fair, taking into account the following factors: the arm-length negotiation process with Luminous Power Technologies Private Limited, the fair market value of home electrical business’ asset at the time of acquisition, the estimated amount additional sales the acquisition could generate and the estimated amount of cost-savings the acquisition could generate. There is no assurance that this home electrical business will not continue to experience operating losses. While we believe that our existing cash resources are sufficient to support our operation and growth strategies, there is no assurance that our acquisition strategy will be successful and we will earn a positive return on our acquisition of home electrical business.

We may fail to realize the anticipated benefits of the acquisition of the home electrical business of Luminous Power Technologies Private Limited for a variety of reasons, including the following:

- failure to successfully manage relationships with customers, distributors and suppliers;
- failure to retain customers during the terms of the brand-use agreement with Luminous Power Technologies Private Limited, and customers to accept products under RR Kabel brand, after the expiration of the brand license agreement dated May 1, 2022 with Luminous Power Technologies Private Limited;
- potential incompatibility of technologies and systems;
- general risks in integration of sales and marketing infrastructures;
- failure to combine product offerings and product lines quickly and effectively; and

- failure to effectively establish and market our ‘RR Signature’ brand or replace ‘Luminous Fans and Lights’ brand with our ‘RR Signature’ brand when the brand license agreement terminates.

If we are unable to realize anticipated benefits of our recent acquisitions, we may be unable to expand our business and improve our market share, realize economies of scales by decreasing our costs, maintain our competitive position, or sustain profitability. There can be no assurance that we will complete any proposed expansion in a timely manner, successfully consolidate any acquired business with our existing operations or whether any of these efforts will achieve the results contemplated by our management. In the event that the risks and uncertainties discussed above or any other unanticipated risks, uncertainties, contingencies or other events or circumstances limit or delay our efforts to expand our business, our business, financial condition, results of operations and cash flows could be materially adversely affected.

22. ***We are subject to strict quality requirements and any product defect issues or failure by us or our raw material suppliers to comply with quality standards may lead to the cancellation of existing and future orders, recalls or exposure to potential product liability claims.***

We face an inherent business risk of exposure to product defects and subsequent liability claims if the use of any of our products results in personal injury or property damage. We and our component suppliers may not be able to meet regulatory quality standards in India or abroad, or the quality standards imposed by our customers and applicable to our manufacturing processes, which could have a material adverse effect on our business, financial condition, results of operations and cash flows. We are also required to obtain material approvals and certifications for product quality verification in India and other jurisdictions. Further, our manufacturing facilities are subjected to rigorous quality control checks, accreditation requirements, and periodic inspections from various regulatory agencies that have issued us product and system certifications. If any of our products do not meet regulatory standards or are defective, we may be, *inter alia*, (i) responsible for damages relating to any defective products, (ii) required to replace, recall or redesign such products, (iii) incur significant costs to defend any such claims or (iv) restricted to produce or market such products to our customers.

Our Company had sales returns amounting to ₹ 180.23 million, ₹ 92.72 million, ₹ 260.96 million, ₹ 23.91 million and ₹ 52.32 million for Fiscals 2021, 2022 and 2023 and three months ended June 30, 2022 and June 30, 2023, respectively, as a result of defective or damaged products, or otherwise due to individual consumer reasons. While there have not been any material product liability claims made against our products or any cancellation of existing or future orders resulting in a material adverse impact on our business, financial condition, results of operations and cash flows, there can be no assurance that this will continue in the future. There can be no assurance that we or our component suppliers comply or can continue to comply with all regulatory requirements or the quality requirement standards of our customers. Because of the long useful life of some our products, it is possible that latent defects might not appear for several years. There is no guarantee that any future non-compliance with quality standards will not result in a material adverse effect on our business, financial condition, results of operations, cash flows and prospects.

The failure by us or any of our suppliers to achieve or maintain compliance with regulatory requirements or quality standards may disrupt our ability to supply products sufficient to meet demand until compliance is achieved or, with a component supplier, until a new supplier has been identified and evaluated. The quality of raw materials and the goods we trade in will have an impact on the quality of the finished products and in turn affect our brand image, business and revenue. There is no assurance that our products will always meet the satisfaction of our customers’ quality standards. Our or our component supplier’s failure to comply with applicable regulations could cause adverse consequences to be imposed on us, including warning letters, fines, injunctions, civil penalties, the refusal of regulatory authorities to grant approvals, delays, suspensions or withdrawal of approvals, license revocation, seizures or recalls of products, operating restrictions and criminal prosecutions, all of which could harm our business. There can be no assurance that if we need to engage new suppliers to satisfy our business requirement, we will be able locate new suppliers in compliance with regulatory requirements in a timely manner, or at all. Failure to do so could lead to the cancellation of existing and future orders and have a material adverse effect on our business and revenue.

23. ***We are highly dependent on our Key Managerial Personnel and our Senior Management Personnel for our business. The loss of or our inability to attract or retain such persons could have a material adverse effect on our business performance.***

Our business and the implementation of our strategy is dependent upon our Key Managerial Personnel and our Senior Management Personnel, who oversee our day-to-day operations, strategy and growth of our business. As of March 31, 2021, March 31, 2022, March 31, 2023 and June 30, 2023, we had three, six, eight and eight Key Managerial Personnel and Senior Management Personnel, respectively. If one or more members of our Key Managerial Personnel and our Senior Management Personnel are unable or unwilling to continue in their present positions, such persons could be difficult to replace in a timely and cost-effective manner. There can be no assurance that we will be able to retain these personnel. The loss of our Key Managerial Personnel or members of our Senior Management or our inability to replace such Key Managerial Personnel or members of our Senior Management may restrict our ability to grow, to execute our strategy, to raise the profile of our brand, to raise funding, to make strategic decisions and to manage the overall running

of our operations, which would have a material adverse impact on our business, results of operations, financial position and cash flows.

During Fiscals 2021, 2022 and 2023 and three months ended June 30, 2022 and June 30, 2023, we have experienced certain changes to our Key Managerial Personnel and our Senior Management Personnel. For further details, see “*Our Management - Changes in our Key Managerial Personnel and Senior Management Personnel in the three immediately preceding years*” on page 257.

The attrition rate of our Key Managerial Personnel and Senior Management Personnel for Fiscals 2021, 2022 and 2023 and for the three months ended June 30, 2022 and June 30, 2023, was 0.00%, 16.67%, 25.00%, 16.67% and 12.50%, respectively. For details in relation to the experience of our Key Managerial Personnel and our Senior Management team, see “*Our Management – Changes in our Key Managerial Personnel and Senior Management in the three immediately preceding years*” on page 257.

We cannot assure you that we will not lose our Key Managerial Personnel or member of Senior Management in the future, or we will be able to replace any Key Managerial Personnel or member of Senior Management in a timely manner or at all, which could have a material adverse impact on our business, results of operations, financial position and cash flows.

24. ***We are highly dependent on our skilled personnel for our day to day operations. The loss of or our inability to attract or retain such persons have a material adverse effect on our business performance.***

Our success in expanding our business will also depend, in part, on our ability to attract, retain and motivate skilled personnel. Competition for skilled personnel in our industry is intense. Our competitors may offer compensation and remuneration packages beyond what we are offering to our employees. We may also be required to increase our levels of employee compensation more rapidly than in the past to remain competitive in attracting employees that our business requires. Because of these factors, there is no assurance that we can effectively attract and retain sufficient number of skilled personnel to sustain our expansion plans, which would have a material adverse impact on our business, results of operations, financial position and cash flows. In Fiscals 2021, 2022 and 2023 and three months ended June 30, 2022 and June 30, 2023, 254, 379, 446, 98 and 109 employees, respectively, terminated their employment with us, representing an attrition rate of approximately 10.96%, 15.36%, 15.98%, 3.54% and 3.55%, respectively.

Our inability to attract and retain skilled personnel may impact our production, day to day operations and in turn adversely impact our results of operations and financial results.

25. ***We have substantial capital expenditure and working capital requirements and may require additional financing to meet those requirements, which could have a material adverse effect on our results of operations, cash flows and financial condition.***

For Fiscals 2021, 2022 and 2023 and three months ended June 30, 2022 and June 30, 2023, our capital expenditures, reflected in our financial statements as additions to property, plant and equipment, intangible asset, intangible assets under development (net of addition minus deletion), capital work-in-progress (net of addition minus deletion) and right-to-use asset, were ₹463.08 million, ₹846.26 million, ₹1,831.07 million, ₹853.12 million and ₹313.90 million, respectively. For reconciliation of non-GAAP measures, see “*Other Financial Information – Reconciliation of Non-GAAP Measures*” on page 372. The actual amount and timing of our future capital expenditure or working capital requirements may differ from estimates due to, among other factors, unforeseen delays or cost overruns, unanticipated expenses, regulatory changes, economic conditions, engineering design changes, weather related delays, technological changes, additional market developments and new opportunities in the wires and cables industry and fast moving electrical good industry. Our sources of additional financing, in the event that we need to draw on them to meet our working capital or capital expenditure needs, may include the incurrence of debt, the issue of equity or debt securities or a combination of both. If we decide to raise additional funds through the incurrence of debt or issuance of debt securities or a combination of both, our interest and debt repayment obligations will increase, which could have a significant effect on our profitability and cash flows. If we do incur debt in the future, our interest and debt repayment obligations will increase, which may adversely affect our profitability and cash flows. We may also become subject to restrictive covenants in our financing agreements, which could limit our ability to access cash flows from operations and undertake certain types of transactions. Please see “*- Our financing agreements contain covenants that limit our flexibility in operating our business. If we are not in compliance with certain of these covenants and are unable to obtain waivers from the respective lenders, our lenders may accelerate the repayment schedules, and enforce their respective security interests, leading to a material adverse effect on our business and financial condition.*” on page 54. Any issuance of equity to raise additional funds, on the other hand, would result in a dilution of the ownership of existing shareholders and our earnings per Equity Share.

Additionally, our ability to obtain additional financing on favorable commercial terms, if at all, will depend on a number of factors, including, amongst others:

- our results of operations and cash flows;

- the amount and terms of our existing indebtedness;
- general market conditions in the markets where we operate; and
- general condition of the debt and equity markets.

In many cases, a significant amount of our working capital is required to finance the purchase of materials before payment is received from our customers. Our trade receivables are non-interest bearing and are generally on credit terms up to 60 days. See “*Management’s Discussion and Analysis of Financial Condition and Results of Operations – Quantitative and Qualitative Analysis of Market Risks – Credit Risk*” on page 399.

Our working capital requirements may increase if the payment terms in our agreements with our customers or purchase orders include reduced advance payments or longer payment schedules, or if our customers’ access to channel financing is reduced. These factors may result in increases in the amount of our receivables and current borrowings. Continued increases in our working capital requirements or our inability to obtain financing at favorable terms, or at all may have a material adverse effect on our financial condition, results of operations and cash flows.

26. *We are subject to warranty claims, which may increase in the future and have a material adverse effect on our financial condition.*

We typically do not provide a guarantee or warranty against manufacturing defects on our wires and cables products, which are in line with the standard practice in the industry in which we operate. We typically provide a warranty of one to two years against manufacturing defects for our fast moving electrical good products. Any defect in our finished fast moving electrical good products may result in customers making a guarantee / warranty claim, and we typically offer to repair / replace our customer products in response to the guarantee / warranty claim. We have had warranty claims made against our products in the ordinary course of our business. Our warranty expenses for Fiscals 2021, 2022 and 2023 and three months ended June 30, 2022 and June 30, 2023 were ₹ 83.66 million, ₹ 148.18 million, ₹ 163.75 million, ₹ 59.96 million and ₹ 40.18 million, respectively, constituting 0.31%, 0.34%, 0.29%, 0.49% and 0.25% of our revenue from operations, respectively. For further details of complaints received from our customers, see “*Our Business – Description of our Business and Operations - Sales and Marketing – Manufacturing Defects and Product Warranties*” on page 216. The warranty claims we receive may increase in the future, and our inability to provide and manage any such increase may have a material adverse effect on our financial condition.

27. *We face significant competitive pressures in our business. Our inability to compete effectively would be detrimental to our business and prospects for future growth.*

We face significant competition in our business from other manufacturers and suppliers of cables and wires and fast moving electrical good products. For details, see “*Industry Overview*” and “*Our Business*” beginning on pages 139 and 190, respectively. According to Technopak, the Indian wires and cables and fast moving electrical good industry is undergoing shifts towards branded play. The market share of the branded players in the domestic wires and cables and fast moving electrical good industry grew from approximately 60% in Fiscal 2015 to approximately 76% in Fiscal 2023. (*Source: Technopak Report*) In Fiscal 2023, the market share of the branded players in the wires and cables industry was nearly 72%, while the market share of the branded players was approximately 67% in the lighting industry, close to 91% in the ceiling fans industry, and 82% in the switches and switchgear industry. (*Source: Technopak Report*)

The industry and markets for our products are characterized by factors such as the shift towards branded play, new technological innovations and increasing demand for energy efficient and premium products. The wires and cables and fast moving electrical good industries are highly competitive with the presence of many national and regional players (manufacturers, traders, suppliers and importers etc.), competing on the basis of factors such as products, price, customer service, post sales services, quality and delivery. (*Source: Technopak Report*)

Due to the fragmented nature of the wires and cables industry and price advantage that the unbranded players generally enjoy, there can be no assurance that we will maintain our competitiveness in wires and cables industry with respect to any of our products. According to Technopak, unbranded players have 28% of the market share of the wires and cable market (by value) in India as of Fiscal 2023. In addition, as a result of the intense competition and accelerated innovation in the fast moving electrical good industry, our ability to achieve and maintain profitability depends on a number of factors, including our investment in research and development, expanding manufacturing capacities at necessary levels, the public perception of our products and the pricing levels of our competitors, some of which is beyond our control. For Fiscals 2021, 2022 and 2023 and three months ended June 30, 2022 and June 30, 2023, the fast moving electrical good segment loss before tax and interest amounted to ₹(300.64) million, ₹(298.41) million, ₹(695.30) million, ₹(148.78) million and ₹(169.53) million, respectively. We expect our fast moving electrical good business to continue to be operated at a loss and we may not be able to achieve and sustain profitability.

While we work consistently to offset pricing pressures, produce new products, advance our technological capability, improve our services or enhance our production efficiency to reduce costs, such efforts may not be successful. Also, as we plan to expand our offerings to launch new products, we may face strong competition from other players in the

same markets, particularly from competitors with backward integrated manufacturing processes. Many of our existing and potential competitors may seek to equal or exceed us in terms of their financial, production, sales, marketing and other resources. If we fail to compete effectively in the future, our business and prospects could be materially and adversely affected.

28. ***If we are unable to anticipate product trends and consumer preferences and develop successful new products, we may not be able to maintain or increase our revenues and profits.***

To keep abreast of the most updated technology and respond effectively to changing customer preferences and requirements, we must be able to develop and produce new products to meet our customers' demand in a timely manner. During the three months ended June 30, 2023, we have launched 6 and 28 new products in the wires and cables and fast moving electrical good segments, respectively. Further, as of June 30, 2023, we have 15 and 55 products under development for wires and cables and fast moving electrical good segments, respectively. For further details in relation to total number of products launched in Fiscals 2021, 2022 and 2023 and three months ended June 30, 2022 and June 30, 2023, see "*Our Business - Description of our Business and Operations – Research and Development*" on page 224.

Our new products may not receive consumer acceptance as consumer preferences could shift rapidly, and our future success depends in part on our ability to anticipate and respond to these changes. If we fail to anticipate accurately and respond to trends and shifts in consumer preferences by adjusting the mix of existing product offerings, developing new products, or fail to install and commission new equipment needed to manufacture products for customers, we could experience lower sales, excess inventories and lower profit margins, any of which could have an adverse effect on our results of operations and financial condition. In addition, market acceptance of new products that we may introduce is subject to uncertainty and achieving market acceptance may require substantial marketing efforts and expenditures. We also cannot assure that our new products will have the same or better margins than our current products. In addition, we may incur, and have in the past, incurred capital expenditures to develop products to meet customer demands and those demands may be delayed at the customers end due to delays in product launches. The failure of the new product lines to gain market acceptance or our inability to maintain our current product margins with the new products could adversely affect our business, financial performance and/or results of operations.

The development of alternative technologies or a fundamental shift in technologies in key markets for our consumer electrical products could have a material adverse effect on our business. The increased acceptance and use of alternative technologies may exert a downward pressure on our sales and consequently have a material adverse effect on our future results of operations, cash flows and financial condition.

29. ***We depend on a limited number of third parties for the supply of our raw materials and delivery of products and such third parties could fail to meet their obligations, which may have a material adverse effect on our business, results of operations, financial condition and cash flows.***

Our primary raw materials include aluminum, copper, galvanized iron, packing material, low smoke zero halogen compound, master batch, solar cable compound, polyvinyl chloride compound and cross-linked polythene compound. We currently manufacture polyvinyl chloride compound, low smoke zero halogen compound, cross-linked polythene compound and solar cable compound in-house at our Waghodia and Silvassa Facilities. We are dependent on a limited number of third-party suppliers for the supply of our raw materials that we do not produce ourselves. As on June 30, 2023, we were dependent on three third-party suppliers for more than 77% of our supply of raw materials being copper and aluminum. See "*Our Business – Description of our Business and Operations - Procurement and Raw Materials*" on page 218. As a result of such dependence, our supply chain may be interrupted by circumstances beyond our control. Poor quality roads and other transportation-related infrastructure and logistics problems, inclement weather and road accidents may disrupt the transportation of raw materials.

Further, we have entered into supply contracts with certain foreign and domestic suppliers for the purchase of these raw materials. Discontinuation of production by these suppliers, failure of these suppliers to adhere to any delivery schedule, failure to provide materials of the requisite quality and quantity or any discontinuation of these supplies as result of a breach of the supply contracts either by our Company or by the suppliers, could hamper our production schedule and therefore have a material adverse effect on our business, results of operations and cash flows.

This dependence may also adversely affect the availability of raw materials to us at reasonable prices, thus affecting our margins, and may have a material adverse effect on our business, financial condition, results of operations and cash flows. Please see "*-The costs of the raw materials that we use in our manufacturing process are subject to volatility. Increases or fluctuations in raw material prices due to any reason may have a material adverse effect on our business, financial condition, results of operations and cash flows.*" on page 28. There can be no assurance that high demand, capacity limitations or other problems experienced by our suppliers such as plant shutdown or transportation strikes will not result in occasional shortages or delays in their supply of raw materials. We cannot assure you that a particular supplier will continue to supply the required components or raw materials to us in the future or at a reasonable price. Further, any change in the supply pattern of our raw materials or the delivery of our products can adversely affect our business and profits.

If we were to experience a significant or prolonged shortage of our primary raw materials from any of our suppliers, and we cannot procure such raw materials from other sources, we would be unable to meet our production schedules for some of our key products and deliver such products to our customers in timely fashion, which would adversely affect our sales, margins and customer relations.

We also use third-party services for the transport of raw materials to our manufacturing plants and finished goods to our direct customers, distributors and dealers, as well as between production facilities. If the third-party deliveries are delayed due to transportation strike, vehicle breakdown, theft or other quality maintenance issues, our business, financial condition, results of operations and cash flows could be materially and adversely affected.

30. ***We engage third party contract manufacturers and our business, financial condition and results of operations may be adversely affected by any material changes to our contract arrangements or any negative impact on our contract manufacturing suppliers.***

We entered into contract with third parties to manufacture certain fast moving electrical goods products. The following table sets forth details of traded goods from third party contract manufacturers for the periods indicated:

	For Fiscals			For Three Months ended June 30,	
	2021	2022	2023	2022	2023
Revenue from operations (₹ million)	27,239.41	43,859.36	55,992.00	12,359.10	15,973.14
Revenue from traded goods (₹ million)	1,522.61	2,110.99	4,322.02	1,007.04	1,282.22
% of revenue from traded goods as compared to revenue from operations (%)	5.59%	4.81%	7.72%	8.15%	8.03%

We depend on these contract manufacturers to allocate to us a portion of their manufacturing capacity sufficient to meet our needs, to produce products of acceptable quality and at acceptable manufacturing yields and to deliver those products to us on a timely basis and at acceptable prices.

However, we cannot guarantee that these contract manufacturers will be able to meet our near-term or long-term manufacturing requirements, which could result in lost sales and have an adverse effect on our business, financial condition, cash flows and results of operation. Other risks associated with our reliance on contract manufactures to manufacture these products include, reliance on the contract manufacturers for regulatory compliance and quality assurance, misappropriation of our intellectual property, limited ability to manage our inventory, possible breach of the manufacturing agreement by the contract manufacturer and the possible termination or non-renewal of the manufacturing agreement by the contract manufacturer at a time that is inconvenient for us. Further, most of our contracts with contract manufacturers are fixed-term contracts or have short duration of approximately three years and are not subject to automatic renewal. Some of our contracts are terminable by the contract manufacturer at a short notice, and if our current contract manufacturers were to terminate their agreements with us or otherwise stop producing products to us on acceptable terms, we may be unable to find alternative manufactures in a timely and efficient manner and on acceptable terms or at all.

Moreover, if any of our contract manufacturers suffer any damage to facilities, lose benefits under material agreements, or otherwise, theft of materials, encounter financial difficulties, are unable to secure necessary raw materials from their suppliers or suffer any other reduction in efficiency, we may experience significant business disruption. In the event of any such disruption, we would need to seek and source other qualified contract manufacturers, likely resulting in further delays and increased costs, which could affect our business adversely.

31. ***We operate in a labor-intensive industry and are subject to stringent labor laws and any strike, work stoppage or increased wage demand by our employees or any other kind of disputes with our employees could adversely affect our business, financial condition, results of operations and cash flows.***

Our manufacturing processes are labor intensive in nature. In the summer months or during the harvesting season, a significant portion of our labor force return to their hometowns for summer holiday and/or to assist their families in the harvesting of crops, resulting in a temporary labor shortage which may affect the production in our manufacturing facilities. Further, if we or our contractors are unable to negotiate with the labor or their sub-contractors, it could result in work stoppages or increased operating costs due to higher than anticipated wages or benefits. In 2017, certain of our employees in our Waghodia Facility went on strike to protest our decision to terminate employment with certain unionized works and contractors, which partially affected our production at such facility for approximately a week. Such strike did not have a material and adverse effect on our business, financial condition and results of operation.

There can be no assurance that we will not experience any strike or work stoppage in the future. In addition, work stoppages or slowdowns experienced by our customers or key suppliers could result in slow-downs or closures of our units where our products are included in the end products. If we or one or more of our customers or key suppliers experience a work stoppage, such work stoppage could have an adverse effect on our business, financial condition, cash flows and results of operations.

During periods of shortages in labor, we may not be able to manufacture our products according to our previously determined time frames, at our previously estimated product costs, or at all, which may adversely affect our business, results of operations, cash flows and reputation.

We are also subject to a number of stringent labor laws that protect the interests of workers, including legislation that sets forth detailed procedures for dispute resolution and employee removal and legislation that imposes financial obligations on employers upon retrenchment. If labor laws become more stringent, it may become more difficult for us to maintain flexible human resource policies, discharge employees or downsize, any of which could have a material adverse effect on our business, financial condition, results of operations, cash flows and prospects.

In addition, we have entered into contracts with independent contractors under the Contract Labor (Regulation and Abolition) Act, 1970, who in turn engage on-site contract labor for performance of certain of our ancillary operations in India. Although our Company does not engage these laborers directly, we may be held responsible for any wage payments to be made to such laborers in the event of default by such independent contractors. Any requirement to fund their wage requirements may have an adverse impact on our results of operations and financial condition. If we are unable to renew the contracts with our independent contractors at commercially viable terms or at all, our business, financial condition, results of operations and cash flows could be materially and adversely affected.

32. *We have entered into collective bargaining agreements with unions of workers at one of our facilities.*

As of the date of this Red Herring Prospectus, our employees at our Waghodia Facility are represented by Bhartiya Karamchhari Sangh affiliated to Bhartiya Mazdoor Sangh-Vadodara (the “**Waghodia Union**”).

As a part of our efforts to resolve the strike at our Waghodia Facility in 2017, we have previously entered into memorandum of settlement with the Waghodia Union in relation to the standard of wage and other corporate benefits for our unionized employees at Waghodia Facility. Such memorandum of settlement usually has a term of three years and is periodically renewed. Our latest memorandum of settlement with the Waghodia Union is dated March 6, 2023 (the “**2023 Waghodia Union Agreement**”), with a term of three years, from April 1, 2022 to March 31, 2025. Pursuant to the 2023 Waghodia Union Agreement, we agreed with the permanent unionized company workmen and the fixed term trainee workmen at Waghodia Facility to, among other things, provide pre-agreed basic wage and certain allowances, including education allowance, house rent allowance on a monthly basis and quarterly performance-based bonus based on the grade of unionized workers, and other customary benefits. We agreed to increase the wage level and monthly settlement amount and introduced the quarterly performance based bonus to better incentivize our unionized workers at our Waghodia Facility. In exchange, the unionized workers agreed to adhere to a matrix of performance standards. If we are not able to adhere to the terms of the 2023 Waghodia Union Agreement, there can be no assurance that our employees represented by the Waghodia Union will not take measures such as work stoppage / slowdowns / strikes in response, any of which will negatively on the operation of our Waghodia Facility, which could, in turn, have a material and adverse effect on our business, results of operation and financial condition.

Further, we cannot assure you that in the future additional employees will not seek to unionize, or unions will not seek to organize additional employees. Union organizing efforts or collective bargaining negotiations could lead to work stoppage and/or slowdowns and/or strikes by our employees, which could have a material adverse effect on our business, financial condition, results of operations, cash flows and prospects. Furthermore, in the event that all or part of our employees are represented by one or more labor union, we may face higher employee costs and increased risks of work stoppages, slowdowns and/or strikes, which could have a material adverse effect on our business, financial condition, results of operations, cash flows and prospects.

33. *We regularly work with hazardous materials and activities in our operation which can be dangerous and could cause injuries to people or property.*

Our business requires individuals to work under potentially dangerous circumstances or with flammable materials. For example, if improperly handled, molten polyvinyl chloride used in production of wires and cables and moving machineries such as stranding machines can seriously hurt or even kill employees or other persons, and cause damage to our properties and the properties of others. Despite compliance with requisite safety requirements and standards, our operations are subject to significant hazards, including explosions, fires, mechanical failures and other operational problems, discharges or releases of hazardous substances, chemicals or gases and other environmental risks. For further details in relation to our insurance coverage, see “*Our Business – Description of our Business and Operations – Insurance*” on page 225.

These hazards can cause personal injury and loss of life or destruction of property and equipment as well as environmental damage. In addition, the loss or shutting down of our facilities resulting from any accident in our

operations could disrupt our business operations and adversely affect our results of operations, financial condition and reputation. We could also face claims and litigation filed on behalf of persons alleging injury predominantly due to occupational exposure to hazards at our facilities. If these claims and lawsuits, individually or in the aggregate, are resolved against us, our business, financial condition, results of operations and cash flows could be adversely affected.

34. ***We are exposed to compliance and internal control related risks.***

As of June 30, 2023, we export our products to 63 countries and as a result, we are required to comply with a broad range of legal and regulatory requirements in a number of jurisdictions, including in the areas of anti-corruption, anti-money laundering, anti-trust and competition. While we generally do not accept payments from third parties for sale of products to our customers, there have been a few instances in the past where we have accepted such payments. In such situations, we provide the banks with remitter details and our customer details along with the relevant invoice numbers. We may not have subjected the third party to our customer on-boarding and other checks or undertaken checks as to the source of funds and co-relation between the third party and our customer. As a result, our compliance and risk management policies, programs and functions may not be effective in managing different types of risks, including risks that we fail to identify or anticipate, as well as misconduct relating to a lack of adequate internal governance or control. For instance, our Company received a notice dated January 27, 2023 from the National Investigation Agency, Ministry of Home Affairs, Government of India, (“Agency”) in relation to payment received from a third party for sale of our products to a long-standing customer. For further details, see “*Outstanding Litigation and Material Developments – Litigation involving our Company – Litigation against our Company – Actions taken by regulatory and statutory authorities*” on page 403. While we provided the necessary documents to the Agency and no further communication has been received by our Company, we cannot assure you that such instances will not occur in the future with adverse consequences for our Company or business. Any failure to effectively prevent, identify or address violations as a result of inadequate internal controls, procedures, compliance systems and risk management systems could result in penalties and other sanctions, liabilities, the assertion of damages claims by third parties, and reputational damage, each of which could have a material adverse effect on our business, operations, financial condition or prospects.

35. ***Our Company is involved in certain legal proceedings. Any adverse decision in such proceedings may render us/them liable to liabilities/penalties and may adversely affect our business, financial condition, results of operations and cash flows.***

Our Company is involved in certain legal proceedings. These legal proceedings are pending at different levels of adjudication before various courts and tribunals or other governmental authorities. The amounts claimed in these proceedings have been disclosed to the extent ascertainable and include amounts claimed jointly and severally from us and other parties. Should any new developments arise, such as any change in applicable Indian law or any rulings against us by appellate courts or tribunals, we may need to make provisions in our financial statements that could increase expenses and current liabilities. Any adverse decision in such legal proceedings may have a material adverse effect on our business, financial condition, results of operations and cash flows. We also investigate and resolve internal complaints we receive in accordance with our policies and as required by law including in relation to complaints from employees including inter-employee related complaints and any failure to investigate and resolve them adequately or at all may result in additional legal proceedings.

A summary of outstanding litigation proceedings involving our Company, our Promoters, our Directors and our Group Companies as on the date of this Red Herring Prospectus and as disclosed in the section titled “*Outstanding Litigation and Other Material Developments*” in terms of the SEBI ICDR Regulations is provided below:

Name of entity	Criminal proceedings	Tax proceedings	Statutory or regulatory proceedings	Disciplinary actions including penalty imposed by the SEBI or Stock Exchanges against our Promoters	Material civil litigations#	Aggregate amount involved* (in ₹ million)
Company						
By the Company	208 ^s	32	-	-	2	461.93
Against the Company	-	7	1	-	-	68.31
Directors						
By our Directors	-	-	-	-	-	-
Against the Directors	-	-	-	-	-	-
Promoters**						
By Promoters	-	-	-	-	-	-
Against Promoters	-	-	-	-	-	-
Group Companies						

Name of entity	Criminal proceedings	Tax proceedings	Statutory or regulatory proceedings	Disciplinary actions including penalty imposed by the SEBI or Stock Exchanges against our Promoters	Material civil litigations#	Aggregate amount involved* (in ₹ million)
By Group Companies	-	-	-	-	-	-
Against Group Companies	-	-	-	-	-	-

Determined in accordance with the Materiality Policy.

* To the extent quantifiable. The amount in dispute in relation to taxation matters is to the extent quantifiable as per notice of demand and excluding any further liabilities towards interest and penalty.

** Other than proceedings involving three of our Promoters, who are also Directors on our Board.

\$ 205 of these matters are cases filed by our Company and Ram Ratna Electricals Limited (now amalgamated with our Company) before various forums for alleged violations of Section 138 of the Negotiable Instruments Act, 1881, involving a total amount aggregating to approximately ₹188.09 million.

There can be no assurance that these litigations will be decided in favor of our Company and such proceedings may divert management time and attention and consume financial resources in their defense or prosecution. An adverse outcome in any of these proceedings may affect our reputation, standing and future business, and could have an adverse effect on our business, prospects, financial condition, results of operations and cash flows. We cannot assure you that any of these proceedings will be decided in our favor or that no further liability will arise out of these proceedings.

36. ***We have commissioned and paid for a report titled “Consumer Electrical Industry in India” from Technopak Advisors Private Limited, which has been used for industry related data in this Red Herring Prospectus.***

We have commissioned and paid for a report titled “Consumer Electrical Industry in India” (the “**Technopak Report**”) dated August 30, 2023, which is exclusively prepared for the purposes of the Offer and issued by Technopak Advisors Private Limited, which has been used for industry related data that has been disclosed in this Red Herring Prospectus. Our Company, our Promoters and our Directors are not related to Technopak Advisors Private Limited. Technopak Advisors Private Limited uses certain methodologies for market sizing and forecasting. Accordingly, investors should read the industry related disclosure in this Red Herring Prospectus in this context. Industry sources and publications are also prepared based on information as of specific dates and may no longer be current or reflect current trends. Industry sources and publications may also base their information on estimates, projections, forecasts and assumptions that may prove to be incorrect. Technopak Advisors Private Limited has advised that while it has taken reasonable care to ensure the accuracy and completeness of the Technopak Report, it believes that the Technopak Report presents a true and fair view of the industry within the limitations of, among others, secondary statistics and primary research, and it does not purport to be exhaustive, and that the results that can be or are derived from these findings are based on certain assumptions and parameters/ conditions. As such, a blanket, generic use of the derived results or the methodology is not encouraged. Further, the Technopak Report is not a recommendation to invest / disinvest in any company covered in the Technopak Report. Accordingly, prospective investors should not base their investment decision solely on the information in the Technopak Report.

The commissioned Technopak Report also highlights certain industry and market data, which may be subject to assumptions. There are no standard data gathering methodologies in the industry in which we conduct our business, and methodologies and assumptions vary widely among different industry sources. Further, such assumptions may change based on various factors. We cannot assure you that Technopak Advisors Private Limited’s assumptions are correct and will not change and, accordingly, our position in the market may differ, favorably or unfavorably, from that presented in this Red Herring Prospectus.

In view of the foregoing, you may not be able to seek legal recourse for any losses resulting from undertaking any investment in the Offer pursuant to reliance on the information in this Red Herring Prospectus based on, or derived from, the Technopak Report. You should consult your own advisors and undertake an independent assessment of information in this Red Herring Prospectus based on, or derived from, the Technopak Report before making any investment decision regarding the Offer.

37. ***We are subject to various laws and extensive government regulations and if we fail to obtain , maintain or renew our statutory and regulatory licenses, permits and approvals required in the ordinary course of our business, including environmental, health and safety laws and other regulations, our business financial condition, results of operations and cash flows may be adversely affected.***

We are required to comply with Indian laws, among other things, relating to occupational health and safety (including laws regulating the generation, storage, handling, use and transportation of waste materials, the emission and discharge of hazardous waste materials into soil, air or water, and the health and safety of employees) and mandatory certification requirements for our facilities and products. For regulations and policies applicable to our Company, see “Key Regulations and Policies” beginning on page 229. There can be no assurance that we will be in compliance at all times

with such laws, regulations and the terms and conditions of any such consents or permits. If we violate or fail to comply adequately with these requirements, we could be fined or otherwise sanctioned by the relevant regulators.

Our business and operations are subject to a number of approvals, licenses, registrations and permissions for construction and operation of our manufacturing facilities, warehouses, branch offices and regional offices, in addition to extensive government regulations for the protection of the environment and occupational health and safety. We have either made or are in the process of making an application or renewal for obtaining necessary approvals that are not in place or have expired. Further, we may also need to apply for additional approvals including the renewal of approvals which may expire from time to time, in the ordinary course of business. For instance, in respect of the Garget Facility, we have made applications for approval of the factory layout plan and consent to operate under the environmental laws and are yet to apply for the factory licence and BIS registration. We cannot assure you that these approvals will be granted by the relevant authorities. In the event these approvals are not granted, we will have to make alternate manufacturing arrangements including increasing production in our other existing manufacturing facilities, which may adversely impact our business, financial condition, results of operations, cash flows and prospects. Further, we may be required to obtain a no objection certificate under the relevant state tenancy laws, when applying for a factory license for the Gagret Facility. For further details of pending renewals and pending material approvals, see “*Government and Other Approvals*” on page 407. If we fail to retain, renew or receive any of such approvals, licenses, registrations, permissions or renewals, in a timely manner or at all, our business, financial condition, results of operations, cash flows and prospects may be adversely affected.

Further, our government approvals and licenses are subject to certain conditions, some of which are onerous and require us to make substantial compliance-related expenditure. If we fail to comply or a regulator claims that we have not complied with such conditions, our business, prospects, financial condition, results of operations and cash flows may be adversely affected.

There can be no assurance that other environmental and safety allegations will not be made against us in the future. The relevant regulator may order closure of our unit where it is found to be non-compliant with the applicable norm. In some instances, such a fine or sanction could adversely affect our business, reputation, financial condition, results of operations or cash flows. In addition, these requirements may become more stringent over time and there can be no assurance that we will not incur significant environmental costs or liabilities in the future. We are also subject to laws requiring the clean-up of contaminated property. Under such laws, we could be held liable for costs and damages relating to contamination at our facilities and at third party sites to which these facilities send waste material, which could have a material adverse effect on our business, financial condition, results of operations and cash flows.

In addition, we may be subject to additional laws, regulations and rules with respect to environment protection, health and safety in the jurisdiction we currently operate. As we expand into new markets, we may be required to comply with various environmental, health and safety laws and regulations. In complying with these additional laws, regulations and rules, we may incur substantial costs, including those relating to maintenance and inspection, development and implementation of emergency procedures and insurance coverage or other additional costs to address environmental incidents or external threats. Our inability to control the costs involved in complying with these and other relevant laws and regulations could have an adverse effect on our business, financial condition, results of operations and cash flows.

38. ***Our failure to maintain optimum inventory levels could adversely affect our business, financial condition, results of operation and cash flow.***

While we manufacture a significant portion of our products for sale based on confirmed orders under direct contractual arrangements, we determine the quantities manufactured for sales and distribution through our distribution networks pursuant to management estimates based on historical levels of sales, actual sale orders on hand and the anticipated production requirements taking into consideration any expected fluctuation in raw material prices and delivery delay.

Our future earnings through the sale and distribution of our products may not be realized as forecasted, due to cancellations or modifications of firm orders or our failure to accurately prepare demand forecasts. If we are unable to appropriately estimate the demand for our products for any reason, it could result in excess inventory levels or the unavailability of our products during increased demand, resulting in loss in potential sales.

Our ability to accurately forecast customer demand for our products is affected by various factors, including:

- a substantial increase or decrease in the demand for our products or for similar offerings of our competitors;
- changes in customer requirements;
- aggressive pricing strategies employed by our competitors;
- failure to accurately forecast or changes in customer acceptance of our products;
- limited historical demand and sales data for our products in newer markets;
- fluctuations in foreign currencies; and

- weakening of general economic conditions or customer confidence that could reduce the sale of our products.

We maintain an inventory level that we think is appropriate to meet our customer demands. We usually keep 20-25 days of inventory of raw materials, work-in-progress and finished goods at our facilities. Our number of inventory days with respect to any period, which we define as the average inventory divided by Cost of Goods Sold (i.e. as cost of materials consumed plus purchase of stock-in-trade plus changes in inventories of finished goods, stock-in-trade, work-in-progress and scrap) multiplied by the number of days in the period (i.e. 365 days for fiscal years and 91 days for three-month periods) is 77 days, 63 days, 63 days, 69 days and 60 days for Fiscals 2021, 2022 and 2023 and three months ended June 30, 2022 and June 30, 2023.

Inventory levels that exceed customer demand may result in inventory write-downs or write-offs or we may be required to sell our excess inventory at discounted prices, which will adversely affect our gross margins and negatively impact our reputation and brand exclusivity. On the other hand, if we face demand in excess of our production, we may not be able to adequately respond to the demand for our products. This could result in delays in delivery of our products to our customers and we may suffer damage to our reputation and customer relationships. In addition, our customers may be driven to purchase products offered by our competitors, thereby affecting our market share. There can be no assurance that we will be able to manage our inventories at optimum levels to successfully respond to customer demand.

39. ***Improper storage, processing and handling of our raw materials, work products and products could damage our inventories and, as a result, have an adverse effect on our business, results of operations and cash flows.***

We typically store our raw materials, work-in-progress, stock in trade and finished goods in covered warehouses. For further details in relation to our warehouses, see “*Our Business -Description of our Business and Operations – Distribution*” on page 213. In the event that our raw materials, work products and products are improperly stored, processed and handled, the quality our raw materials, such as copper, aluminum and PVC compound, could be reduced and our work products could be damaged. As a result, our production outputs could be adversely affected, which could have a material adverse effect on our business, financial condition, results of operations and cash flows.

40. ***Information relating to historical installed capacity and estimated capacity utilization of our manufacturing facilities included in this Red Herring Prospectus is based on various assumptions and estimates and our future production and capacity utilization may vary. Under-utilization of our manufacturing capacity and an inability to effectively utilize our manufacturing facilities may have an adverse effect on our business and future financial performance.***

Information relating to our historical installed capacity and estimated capacity utilization of our manufacturing facilities included in this Red Herring Prospectus is based on various assumptions and estimates of our management and independent chartered engineer, namely, Vishvakarma Consultancy Services Private Limited, including proposed operations, assumptions relating to availability and quality of raw materials, potential utilization levels and operational efficiencies. For further information regarding our manufacturing facilities, including our historical installed capacity and estimated capacity utilization, see “*Our Business—Description of our Business and Operations - Manufacturing Facilities*” and “*Our Business—Description of our Business and Operations – Capacity and Capacity Utilization*” on pages 209 and 210, respectively. Actual and future manufacturing volumes and capacity utilization rates may differ significantly from the estimated production capacities of our manufacturing facilities. Undue reliance should therefore not be placed on the information relating to our installed capacities or historical capacity utilization of our manufacturing facilities included in this Red Herring Prospectus.

Further, there is no guarantee that our future production or capacity utilization levels will match or exceed our historical levels. In addition, we intend to continue to evaluate options to further backward integrate other aspects of our manufacturing process, which will allow us to reduce the reliance on the supply chain, particularly third party vendors and suppliers, ensure quality control and give us cost optimization opportunities. For instance, we have backward integrated our manufacturing process by producing several key raw materials such as PVC compound, LS0H compound, XLPE compound and solar cable compound. We intend to start manufacturing other raw materials such as thermoset e-beamable low smoke zero halogen compound and ethylene propylene rubber compound in Fiscal 2024. There is no assurance that we will be successful in our backward integration business strategy or that the capacity utilization of our manufacturing facilities, including any new manufacturing facilities, will operate at an optimal level which will enable us to achieve operational efficiencies and achieve our expected return on capital invested. Under-utilization of our manufacturing capacities over extended periods, or significant under-utilization in the short term could increase our cost of production and our operating costs and adversely impact our business, growth prospects and future financial performance. Our expected return on capital invested is subject to, among other factors, the ability to ensure satisfactory performance of personnel to further grow our business, our ability to absorb additional infrastructure costs and utilize the expanded capacities as anticipated. In case of oversupply in the industry or lack of demand, we may not be able to utilize our capacity efficiently.

41. ***A portion of the Net Proceeds may be utilized for repayment or pre-payment of loans taken from Citicorp Finance India Limited and HSBC Bank Limited, which are affiliates of two of the Book Running Lead Managers, Citigroup Global Markets India Private Limited and HSBC Securities and Capital Markets (India) Private Limited.***

Our Company has availed certain loans from Citicorp Finance India Limited and HSBC Bank Limited which comprised of 0.96% and 2.32% of the total outstanding borrowings (both fund based and non-fund based), respectively of the Company as of August 28, 2023. We propose to use the Net Proceeds to make repayment or prepayments towards the outstanding amounts in relation to these borrowings. For details, including in relation to the nature and purpose of the borrowings as well as the sanctioned and outstanding amount as on August 28, 2023, see “*Objects of the Offer*” on page 113. Citicorp Finance India Limited and HSBC Bank Limited are affiliates of two of our Book Running Lead Managers, Citigroup Global Markets India Private Limited and HSBC Securities and Capital Markets (India) Private Limited, and they are not our associates in terms of Securities and Exchange Board of India (Merchant Bankers) Regulations, 1992, as amended (“**MB Regulations**”). Loans and facilities sanctioned to our Company by Citicorp Finance India Limited and HSBC Bank Limited are a part of their respective normal commercial lending activity and we do not believe that there is any conflict of interest under the MB Regulations, or any other applicable SEBI rules or regulations. However, the amount of Net Proceeds utilized towards such repayment or prepayment to Citicorp Finance India Limited and HSBC Bank Limited, will not be available for use in our business for any other purposes. For details, see “*Objects of the Offer*” on page 113.

42. ***We are entitled to certain tax benefits. These tax benefits are available for a definite period of time, which, on expiry or if withdrawn prematurely, may adversely affect our business, financial condition, results of operations, cash flows and prospects.***

We are entitled to certain tax benefits under direct tax laws and indirect tax laws such as certain specific deductions under the Income-tax Act 1961, certain customs duty exemption on import of inputs and capital goods, refund of accumulated input tax credit on certain exports, rebate of taxes and duties on inputs at applicable rates, duty drawback of duty paid on import of materials used in manufacture of exported goods. For further details, see “*Statement of Special Tax Benefits*” beginning on page 131.

Our profitability will be affected to the extent that such benefits will not be available beyond the periods currently contemplated. Our profitability may be further affected in the future if any of such benefits are reduced or withdrawn prematurely or if we are subject to any dispute with the tax authorities in relation to these benefits or in the event we are unable to comply with the requisite conditions to avail ourselves of each of these benefits. If any adverse development in the law or the manner of its implementation affects our ability to benefit from these tax incentives, our business, financial condition, results of operations, cash flows and prospects may be materially adversely affected.

43. ***If we fail to maintain an effective system of internal controls, we may not be able to successfully manage, or accurately report, our financial risks. Despite our internal control systems, we may be exposed to operational risks, including fraud, petty theft and embezzlement, which may adversely affect our reputation, business, financial condition, results of operations and cash flows.***

Effective internal controls are necessary for us to prepare reliable financial reports and effectively avoid fraud. Moreover, any internal controls that we may implement, or our level of compliance with such controls, may deteriorate over time, due to evolving business conditions.

Notwithstanding that the auditors’ report issued on the internal financial controls over financial reporting of our Company for Fiscals 2021, 2022 and 2023 did not contain a qualified opinion or disclaimer of opinion, there can be no assurance that deficiencies in our internal controls will not arise in the future, or that we will be able to implement, and continue to maintain, adequate measures to rectify or mitigate any such deficiencies in our internal controls. Any inability on our part to adequately detect, rectify or mitigate any such deficiencies in our internal controls may adversely impact our ability to accurately report, or successfully manage, our financial risks, and to avoid fraud, each of which may have an adverse effect on our business, financial condition, results of operations and cash flows.

Further, given the high volume of transactions we process on a daily basis, notwithstanding the internal controls that we have in place, we may be exposed to the risk of fraud or other misconduct by employees, contractors, customers, distributors or dealers. Fraud and other misconduct can be difficult to detect and deter. Certain instances of fraud and misconduct may go unnoticed or may only be discovered and successfully rectified after substantial delays. Even when we discover such instances of fraud or theft and pursue them to the full extent of the law or with our insurance carriers, there can be no assurance that we will recover any of the amounts involved in these cases. In addition, our dependence upon automated systems to record and process transactions may further increase the risk that technical system flaws or employee tampering or manipulation of those systems will result in losses that are difficult to detect, which may adversely affect our reputation, business, financial condition, results of operations and cash flows.

44. ***Failure or disruption of our information technology systems may adversely affect our business, financial condition, results of operations, cash flows and prospects.***

We have implemented various information technology solutions to cover key areas of our operations including sourcing, planning, manufacturing, supply chain, accounting, distribution network and data security. For further details, see “*Our Business -Description of our Business and Operations – Information Technology*” on page 227. However, these systems are potentially vulnerable to damage or interruption from a variety of sources, which could result in a material adverse effect on our operations. A large-scale information technology malfunction could disrupt our business or lead to disclosure of, and unauthorized access to, sensitive Company information. Our ability to keep our business operating depends on the proper and efficient operation and functioning of various information technology systems, which are susceptible to malfunctions and interruptions (including those due to equipment damage, power outages, computer viruses and a range of other hardware, software and network problems). Such malfunction or disruptions could interrupt our business operations and result in economic losses. Any failure of our information technology systems could also cause damage to our reputation which could harm our business. Any of these developments, alone or in combination, could have a material adverse effect on our business, financial condition, results of operations and cash flows.

From April 25 to April 28, 2021, we were not able to access our internal enterprise resources planning system as a result of a computer virus on our cloud servers. We restored the functionality of our enterprise resources planning system on April 28, 2021. In consultation with our external vendors, we determined that the virus was planted on our system due to improper access to one of our server terminals through a public internet protocol address. We revised our information technology policy to permit access to our server terminals only through virtual private network to prevent similar instances in the future. There is no assurance that we will not experience disruption in our information technology systems in the future and we will be able to remedy such disruption in timely manner, or at all. Any such disruption of our information technology systems could have a material adverse effect on our business, results of operation and financial condition.

Further, unavailability of, or failure to retain, well trained employees capable of constantly servicing our information technology systems may lead to inefficiency or disruption of our information technology systems, thereby adversely affecting our ability to operate efficiently.

Any failure in overhauling or updating our information technology systems in a timely manner could cause our operations to be vulnerable to external attacks and inefficient. Hence, any failure or disruption in the operation of these systems or the loss of data due to such failure or disruption (including due to human error or sabotage) may affect our ability to conduct our normal business operations, which may materially adversely affect our business, financial condition, results of operations, cash flows and prospects. In addition, technological advances from time to time may result in our systems, methods or processing facilities becoming obsolete.

Further, we are dependent on various external vendors for certain elements of our operations and are exposed to the contractual risks and operational risks of these external vendors. Their failure to perform their contractual obligations could materially and adversely affect our business, results of operations and cash flows.

45. ***Our suppliers and customers may engage in certain transactions in or with countries or persons that are subject to international economic sanctions.***

Various international jurisdictions, including the United States and the United Kingdom, restrict investments or otherwise doing business in or with certain countries or territories and with certain persons or businesses that have been specially designated by such government agencies. Other governments and international or regional organizations also administer similar economic sanctions.

Our suppliers and customers may be located in and/ or may enter into transactions with end customers, either directly or indirectly through distributors and agents, located in, jurisdictions to which certain Office of Foreign Assets Control-administered and other sanctions apply, such as Turkey and Myanmar. We have exported our products to entities located in Myanmar representing 0.58% of our total income in three months ended June 30, 2023. Further, we have imported stores, spares and capital goods from entities located in Turkey representing less than 0.01% of our total expense in three months ended June 30, 2023. For further details in relation to our revenue from outside India, see “*Management’s Discussion and Analysis of Financial Condition and Results of Operations – Segment Reporting – Information about revenue split by geographical area.*” on page 388.

Although we do not qualify (i) as a U.S. person under the various U.S. sanctions programs administered by Office of Foreign Assets Control or (ii) as “owned or controlled” by a U.S. person for purposes of the Office of Foreign Assets Control sanctions targeting Myanmar, and we believe we comply fully with international sanctions to the extent applicable to us, there can be no assurance that we will be able to fully monitor the transactions for any potential violation. If we fail to comply with current or future applicable laws we could incur significant fines and other penalties and suffer negative publicity and reputational damage, which could have an adverse effect on our financial condition, cash flows, results of operations or business. Further, investors in the Equity Shares could incur reputational or other risks as a consequence. There can be no assurance that our future business will be free of risk under sanctions implemented by these jurisdictions or that we will be able to conform our business operations to the expectations and requirements of such international regulatory agencies that do not have jurisdiction over our business but nevertheless assert the right to impose sanctions on an extraterritorial basis.

46. ***A downgrade in our credit ratings could materially adversely affect our business and financial condition and our ability to raise capital in the future.***

The credit ratings assigned to us and our borrowing facilities could change based upon, among other things, our results of operations and financial condition. The following table sets forth the affirmation and upgrades on our India Ratings and Research Long-Term Issuer Rating and Outlook for the last five years:

	July 20, 2018	April 4, 2019	June 5, 2020	September 30, 2021	December 19, 2022
Rating	IND A	IND A	IND A+	IND AA-	IND AA-
Outlook	Stable	Positive	Stable	Stable	Stable

We have also been assigned an additional bank facility rating of 'IND A+' with a Stable outlook on September 17, 2020 by India Ratings and Research.

These ratings are subject to ongoing evaluation by credit rating agencies, and we cannot assure you that any rating will not be changed or withdrawn by a rating agency in the future if, in its judgment, circumstances warrant. Moreover, these credit ratings are not recommendations to buy, sell or hold the equity securities. If any of the credit rating agencies that have rated us and our borrowing facilities downgrades or lowers our credit ratings, or if any credit rating agency indicates that it has placed any such rating on a so-called "watch list" for a possible downgrading or lowering or otherwise indicates that its outlook for that rating is negative, it could have a material adverse effect on our costs and availability of capital, which could in turn have a material adverse effect on our financial condition, results of operations, cash flows and our ability to raise capital in the future. However, we cannot assure you that our credit ratings will not be lowered or withdrawn by credit rating agencies that rate us, which could have a material adverse effect on our financial condition, results of operations, cash flows and our ability to raise capital in the future.

47. ***Our financing agreements contain covenants that limit our flexibility in operating our business. If we are not in compliance with certain of these covenants and are unable to obtain waivers from the respective lenders, our lenders may accelerate the repayment schedules, and enforce their respective security interests, leading to a material adverse effect on our business and financial condition.***

As at June 30, 2023, our borrowings, on a consolidated basis, were ₹4,037.65 million. A portion of these borrowings is secured by mortgage of immovable properties, hypothecation of current assets (both present and future), fixed immovable assets and personal guarantees given by our Promoters and Directors. The details of the outstanding guarantees given by the Promoters and Directors in relation to loans availed by our Company as on June 30, 2023 are as follows:

S. No.	Date of sanction letter/ deed of guarantee	Guarantee given by	Lender	Type of facility	Sanctioned amount of facility (in ₹ million)
1.	March 25, 2021	Tribhuvanprasad Rameshwarlal Kabra, Mahendrakumar Rameshwarlal Kabra and Shreegopal Rameshwarlal Kabra	State Bank of India	Cash credit, pre-shipment and post-shipment, overdraft, letter of credit facility	1,215.00
			Standard Chartered Bank		900.00
			DBS Bank India Limited		250.00
			Yes Bank Limited		250.00
			HSBC Limited		600.00
			Kotak Mahindra Bank Limited		435.00
			Citibank NA.		300.00
			HDFC Bank Limited		700.00
2.	July 3, 2019	Tribhuvanprasad Rameshwarlal Kabra and Mahendrakumar Rameshwarlal Kabra	Federal Bank Limited	Working capital facility and forward cover limit	450.00
3.	November 26, 2019	Tribhuvanprasad Rameshwarlal Kabra and Mahendrakumar Rameshwarlal Kabra	DBS Bank India Limited	Working capital facility	500.00
4.	January 7, 2020	Tribhuvanprasad Rameshwarlal Kabra, Mahendrakumar Rameshwarlal Kabra and Shreegopal Rameshwarlal Kabra	HDFC Bank Limited	Short term loan	270.00
5.	December 2, 2019	Tribhuvanprasad Rameshwarlal Kabra, Mahendrakumar Rameshwarlal Kabra	HDFC Bank Limited*	Rupee term loan	1,000.00

S. No.	Date of sanction letter/ deed of guarantee	Guarantee given by	Lender	Type of facility	Sanctioned amount of facility (in ₹ million)
		and Shreegopal Rameshwarlal Kabra			
6.	September 30, 2017	Tribhuvanprasad Rameshwarlal Kabra, Mahendrakumar Rameshwarlal Kabra and Shreegopal Rameshwarlal Kabra	Citicorp Finance (India) Limited [#]	Rupee term loan	600.0
7.	May 11, 2021	Tribhuvanprasad Rameshwarlal Kabra and Mahendrakumar Rameshwarlal Kabra	Axis Bank Limited	Working capital facility and letter of credit	300.00
8.	December 18, 2017	Tribhuvanprasad Rameshwarlal Kabra, Mahendrakumar Rameshwarlal Kabra and Shreegopal Rameshwarlal Kabra	Kotak Mahindra Bank Limited	Working capital facility	65.00
9.	March 12, 2020	Tribhuvanprasad Rameshwarlal Kabra, Mahendrakumar Rameshwarlal Kabra and Shreegopal Rameshwarlal Kabra	HSBC Limited	Working capital facility	400.00
10.	August 11, 2021	Tribhuvanprasad Rameshwarlal Kabra and Mahendrakumar Rameshwarlal Kabra	Yes Bank Limited	Letter of credit	650.00

[†] Personal guarantee is executable on the outstanding amount of ₹437.47 million as on June 30, 2023.

[#] Personal guarantee is executable on the outstanding amount of ₹74.45 million as on June 30, 2023.

Our existing financing arrangements contain a number of restrictive covenants that impose significant operating and financial restrictions on us and may limit our ability to, without prior consents from the lenders, engage in acts that may be in our long-term best interest, including restrictions on our ability to, among other matters, make loans and investments, change our capital structure, undertake merger or amalgamation, change our ownership and composition of our board of directors, issue further Equity Shares, make certain payments (including payment of dividends, redemption of shares and prepayment of indebtedness), alter the business we conduct, carry out modifications, amendments or alterations to the constitutional documents of the Company, enter into borrowing arrangements with any other bank, financial institution, company or otherwise, create any charges, lien or encumbrances over our assets or undertaking or any part thereof in favor of any third party, or sell, assign, mortgage or dispose off any fixed assets charged to a lender or wind-up, liquidate or dissolve affairs or take steps for voluntary winding up or liquidation or dissolution.

If we are not in compliance with certain of these covenants and are unable to obtain waivers from the respective lenders or if any events of default occur, our lenders may accelerate the repayment schedules or terminate our credit facilities. Further, certain of our subsisting loans may be recalled at any time at the option of the lender. There can be no assurance that the lenders will not recall such borrowings or if we will be able to repay loans advanced to us in a timely manner or at all. Subsequently, if we are unable to pay our debt, affected lenders could also proceed against any collateral granted to them to secure such indebtedness. Further, such covenant defaults could result in cross-defaults in our other debt financing agreements. In the event our lenders accelerate the repayment of our borrowings, there can be no assurance that we will have sufficient assets to repay our indebtedness.

If our future cash flows from operations and other capital resources become insufficient to pay our debt obligations or our contractual obligations, or to fund our other liquidity needs, we may be forced to sell assets or attempt to restructure or refinance our existing indebtedness. Our ability to restructure or refinance our debt will depend on the condition of the capital markets, our financial condition at such time and the terms of our other outstanding debt instruments. Any refinancing of our debt could be at higher interest rates and may require us to comply with more onerous covenants, which could further restrict our business operations. The terms of existing or future debt instruments may restrict us from adopting some of these alternatives. In addition, any failure to make payments of interest or principal on our outstanding indebtedness on a timely basis would likely result in a reduction of our creditworthiness or credit rating, which could harm our ability to incur additional indebtedness on acceptable terms.

48. ***Certain of our manufacturing properties are located on leasehold lands. If we are unable to renew existing leases or relocate our operations on commercially reasonable terms, there may be a material adverse effect on our business,***

financial condition and operations. Certain of our warehouses are not registered in our name, which could have a material adverse effect on our business financial condition and operations.

Two of our manufacturing facilities, namely our Gagret Facility and Bengaluru Facility, are located on leasehold lands. For further details, see “*Our Business –Description of our Business and Operations – Properties*” on page 227. If we are unable to renew certain or all of these leases on commercially reasonable terms or at all and we cannot relocate our manufacturing facilities in a timely manner, we may suffer a disruption in our operations, and our results of operations, financial condition and cash flows may be materially and adversely affected.

In addition, our warehouse in Howrah, which we purchased in 2016, have not been registered in our name. If we are not able to procure the third party seller to register the warehouse in our name, we are denied access to the warehouse, and we cannot find a suitable replacement in a timely manner, we may suffer a disruption in our operations, and our results of operations, financial condition and cash flows may be materially and adversely affected.

49. *We conduct a portion of our operations through a joint venture and our control over the joint venture is limited by the interests of our joint venture partners.*

We have entered into a joint venture agreement with third parties to expand our production capacity and address local customer’s demands more effectively. In December 2010, we, along with MEW Electricals Limited, and Ram Ratna Wires Limited, , both of which are our Group Companies, entered into a joint venture agreement with six Bangladeshi individuals (“**Joint Venture Partners**”), who are in the business of manufacturing and processing of, and buying, among other things, all kinds of wires, litz wires, cables, felexes, telecables, non-ferrous conductors and all electrical goods in Bangladesh, to establish RR-Imperial Electricals Limited (the “**Joint Venture**”). For details, see “*Our Business*” on page 190. As on June 30, 2023, our shareholding in the Joint Venture is 35%. For Fiscals 2021, 2022 and 2023 and three months ended June 30, 2022 and June 30, 2023, share of profit/(loss) of joint venture net of tax accounted for 0.04%, 0.10%, 0.02%, (0.01)% and 0.04%, respectively of our revenue from operations in such periods.

Certain business actions of the Joint Venture require consent of our Joint Venture Partner. These actions include, among others, any borrowings or financial accommodation by the Joint Venture in excess of an amount equivalent to approximately ₹38.20 million (Bangladesh Taka 50.00 million), incurring or authorizing capital expenditures in excess of the current capital expenditure by 10%, pledging or encumbering any of the Joint Venture’s assets, entering into any loans, guarantees, indemnities, charges or other security arrangements by the Joint Venture, except in the ordinary course of business and excluding those which together remain below an amount of approximately ₹15.30 million (Bangladesh Taka 20.00 million), and incurring any liability or entering into contracts, commitments, obligations or undertakings of any kind, when such liability or commitment is in excess of an amount of approximately ₹38.20 million (Bangladesh Taka 50.00 million). Due to these restrictions, we may be constrained in our ability to expand our Joint Venture operations, raise capital for our Joint Venture operations, or to flexibly respond to any changing business environment. Any of the foregoing may have a material adverse effect on our business in Bangladesh, which in turn, could have a material adverse our business, financial condition, results of operations, cash flows and prospects.

In addition, our participation in the Joint Venture is subject to risks that may not be present with other method of ownership, including but not limited to:

- our interests and those of our Joint Venture Partners may not always be aligned, resulting in, among other things, possible project delays, additional costs, disagreements and / or other conflict of interest issues;
- we could experience an impasse on certain decisions because we do not have sole decision-making authority, which could require us to expend additional resources to resolve such impasses or potential disputes, including litigation or arbitration;
- the Joint Venture may not be able to obtain or renew approvals and permits in a timely manner from the jurisdictions in which it operates;
- we may also suffer unexpected costs or other losses if any of our Joint Venture Partners become insolvent, is unable to pay its debts as they fall due, does not meet the obligations under the agreements governing our relationship with the Joint Venture Partners, or if such violations lead to fines, penalties, restrictions, withdrawal of licenses and termination of the agreements under which the Joint Venture operates; and
- our ability to transfer our interest in the Joint Venture to a third party may be restricted and the market for our interest may be limited.

50. *We have certain contingent liabilities and commitments, which, if they materialize, may adversely affect our results of operations, financial condition and cash flows.*

Our contingent liabilities and commitments as of June 30, 2023 are as follows:

Particulars	Amount (₹ in million)
Contingent Liabilities	

Particulars	Amount (₹ in million)
Claims against our Company not acknowledged as debts	
• Service tax demands	39.20
• Income tax demands	31.71
• Sales tax / VAT demands	96.73
• Labor law demand	1.91
Channel Financing guarantee	225.00
Total	394.55
Commitments	
On capital account (net of advance)	834.78
Contingent Liabilities and Commitments	1,229.33

If any such contingent liability or commitment materializes, it could have an adverse effect on our results of operations, financial condition and cash flows. For details, see “*Management’s Discussion and Analysis of Financial Condition and Results of Operations – Liquidity and capital resources*”, “*Management’s Discussion and Analysis of Financial Condition and Results of Operations – Contingent Liabilities and Commitments*” and “*Financial Information*” beginning on pages 397, 398 and 269, respectively.

51. *Our Promoters and Promoter Group will continue to retain a majority shareholding in our Company after the Offer, which will allow them to exercise significant influence over us.*

After the completion of the Offer, our Promoters and Promoter Group is expected to hold [●]% of our outstanding Equity Shares. Further, the involvement of our Promoters in our operations, including through strategy, direction and customer relationships have been integral to our development and business and the loss of any of our Promoters may have a material adverse effect on our business and prospects.

Accordingly, our Promoters and Promoter Group will continue to exercise significant influence over our business and all matters requiring shareholders’ approval, including the composition of our Board of Directors, the adoption of amendments to our constitutional documents, the approval of mergers, strategic acquisitions or joint ventures or the sales of substantially all of our assets, and the policies for dividends, investments and capital expenditures. This concentration of ownership may also delay, defer or even prevent a change in control of our Company and may make some transactions more difficult or impossible without the support of our Promoters and Promoter Group. Further, the Promoters’ shareholding may limit the ability of a third party to acquire control. The interests of our Promoters and Promoter Group, as our Company’s controlling shareholder, could conflict with our Company’s interests, your interests or the interests of our other shareholders. There is no assurance that our Promoters and Promoter Group will act to resolve any conflicts of interest in our Company’s or your favor.

52. *Our Directors and Promoters may enter into ventures that may lead to real or potential conflicts of interest with our business.*

The interests of our Directors or Promoters may conflict with the interests of our other Shareholders due to their involvement in other ventures that may compete with our business or may benefit from preferential treatments when doing business with our Company. Our Directors, or Promoters, as applicable, may, for business considerations or otherwise, in transactions with other ventures where they have interest, cause our Company to take actions, or refrain from taking actions, in order to benefit themselves instead of our Company’s interests or the interests of its other Shareholders and which may be harmful to our Company’s interests or the interests of our other Shareholders, which may materially adversely impact our business, financial condition, results of operations and cash flows.

Certain companies or firms controlled by our Promoters deals in our products by purchasing directly from our Company. For instance, Ram Ratna International, a member of our Promoter Group, trades in our products to sell in the overseas markets. As a result, conflicts of interest may arise when we sell our products to such Promoter Group Company at lower prices, or give it any other form of preferential treatment. In cases of conflict, our Promoters, who will continue to retain majority shareholding in our Company (directly and indirectly) subsequent to the Issue, may favor other companies in which our Promoter has interests. There can be no assurance that our Promoters or any company controlled by our Promoters will not compete with our existing business or any future business that we may undertake or that their interests will not conflict with ours. Any such present and future conflicts could have a material adverse effect on our reputation, business, results of operations, cash flows and financial condition. For further details of our Group Companies, see “*Our Group Companies*” beginning on page 265.

53. *We have acquired and agreed to acquire land in the last five years from entities related to our Promoters and Directors and may undertake such transactions in the future.*

We have purchased land measuring approximately 47,652 square metres in Waghodia from MEW Electricals Limited, one of our Group Companies, for a consideration of ₹128.66 million pursuant to a sale deed dated January 10, 2019. We have also agreed to purchase land measuring approximately 34,358 square metres in aggregate in Silvassa for a

total consideration of ₹135.71 million pursuant to two agreements for sale, each dated March 7, 2023, from Ram Ratna Wires Limited. Subsequently, we entered into a sale deed dated August 18, 2023 for the purchase of land measuring approximately 20,353 square metres in Karad, Dadra and Nagar Haveli for a total consideration of ₹80.39 million from Ram Ratna Wires Limited. Further, pursuant to a resolution passed by our Board on September 2, 2021, we have also agreed to purchase land measuring approximately 4,149 square metres in Waghodia from MEW Electricals Limited, for a consideration of ₹8.50 million.

While we believe such related party transactions have been conducted on an arms-length basis, there can be no assurance that we could not have achieved more favorable terms had such transactions not been entered into with related parties. In the future, we may undertake further acquisitions of land from our Promoters or Directors, or entities related to them.

54. ***Our ability to pay dividends in the future will depend on our future cash flows, working capital requirements, capital expenditures and financial condition.***

We have declared and paid dividend in the previous three financial years. For details, see “Dividend Policy” on page 268. However, the amount of our future dividend payments, if any, will depend on our future earnings, cash flows, financial condition, working capital requirements, capital expenditures, applicable Indian legal restrictions and other factors. There can be no assurance that we will pay dividends. We may decide to retain all of our earnings to finance the development and expansion of our business and, therefore, may not declare dividends on our Equity Shares. Additionally, in the future, we may be restricted by the terms of our financing agreements in making dividend payments unless otherwise agreed with our lenders.

55. ***We have entered, and will continue to enter, into related party transactions which may involve conflicts of interest. Further, our Promoters, Directors and Key Managerial Personnel have interests in us other than reimbursement of expenses incurred and normal remuneration or benefits.***

We have in the past entered into certain related party transactions with our Key Managerial Personnel, Directors, relatives of Key Managerial Personnel, entities over which Key Managerial Personnel and their relatives are able to exercise significant influence and our Joint Venture. Further, our Promoters, Directors and Key Managerial Personnel have interests in us other than reimbursement of expenses incurred and normal remuneration or benefits. For further details in relation to our related party transactions for Fiscals 2021, 2022 and 2023 and three months ended June 30, 2022 and June 30, 2023, see “Summary of the Offer Document – Summary of Related Party Transactions” and “Other Financial Information – Related Party Transactions” on pages 18 and 375, respectively. While we believe that all such related party transactions for Fiscals 2021, 2022 and 2023 and three months ended June 30, 2022 and June 30, 2023, have been conducted on an arm’s length basis and are in compliance with applicable law, including the Companies Act, we cannot assure you that we could not have obtained more favorable terms had such transactions been entered into with unrelated parties.

56. ***The determination of the Price Band is based on various factors and assumptions and the Offer Price of the Equity Shares may not be indicative of the market price of the Equity Shares upon listing on the Stock Exchanges. Further, the current market price of some securities listed pursuant to initial public offerings which were managed by the Book Running Lead Managers in the past, is below their respective issue prices.***

The determination of the Price Band and discount, if any, is based on various factors and assumptions, and will be determined by our Company and the Investor Selling Shareholder in consultation with the Book Running Lead Managers. Furthermore, the Offer Price of the Equity Shares will be determined by our Company and the Investor Selling Shareholder in consultation with the Book Running Lead Managers through the Book Building Process. These will be based on numerous factors, including those described under “Basis for Offer Price” on page 120, and may not be indicative of the market price of the Equity Shares upon listing on the Stock Exchanges. The price of our Equity Shares upon listing on the Stock Exchanges will be determined by the market and may be influenced by many factors outside of our control. For further details, see “ – The Equity Shares have never been publicly traded, and, after the Offer, the Equity Shares may experience price and volume fluctuations, and an active trading market for the Equity Shares may not develop. Further, the price of the Equity Shares may be volatile, and you may be unable to resell the Equity Shares at or above the Offer Price, or at all.” on page 63. Further, the current market price of securities listed pursuant to certain previous initial public offerings managed by the Book Running Lead Managers is below their respective issue prices. For further details, see “Other Regulatory and Statutory Disclosures – Price information of past issues handled by the Book Running Lead Managers” on page 416.

57. ***The COVID-19 pandemic has had a material and adverse impact on our business and operations, and it may continue to have an adverse effect on our business prospects and future financial performance.***

The outbreak of the COVID-19 pandemic and its continuing impact, as well as government measures to reduce the spread of the COVID-19 pandemic, has impacted our operations and could continue to materially and adversely affect our business in the future. As a result of the COVID-19 pandemic, our ability to perform critical functions of our business, such as manufacturing, managing production, sourcing supplies, planning expansion, engaging with customers and prospective customers, was adversely affected. In Fiscal 2021, we temporarily closed our five

manufacturing facilities in April 2020 for a month to comply with quarantine measures / stay-home orders issued by the government to contain the spread of COVID-19, and briefly closed our five manufacturing facilities in March and April 2021 for the same reason. The temporary disclosure of our facilities reduced our production outputs, delayed our production schedule and negatively impacted our revenue and results of operations for Fiscal 2021. In addition, in Fiscal 2022, as a result of supply chain disruption caused by COVID-19, we experienced shortages and difficulties in sourcing PVC resin, which is a type of raw materials used in our wires and cables production. In Fiscal 2022, three shipments of polyvinyl chloride resin of total 500 metric tonnes were delayed for approximately 50 days. We eventually purchased the polyvinyl chloride resin needed for our production from local suppliers at higher costs.

The COVID-19 pandemic has resulted in, and may in the future, result in, significant economic volatility and uncertainty in Indian and international markets, which could adversely affect the level of demands for our products, the availability and price level of our raw materials and our access to capital markets, which could have a material and adverse effect on our business, financial condition and prospects.

58. ***Our performance is subject to seasonality.***

The wires and cables and fast moving electrical good industry is subject to seasonality. Typically, customers purchase FMEG products such as fans and water heaters due to seasonal factors. For example, fans sales increase leading up to the summer season and water heaters sales increase in the cooler winter months. For our wires and cables business, sales are slower in the first of the year as certain customers may not have finalized their annual business plans or budgets at the start of the year. These factors result in the second half of the fiscal year seeing higher sales volume compared to the first half of the fiscal year.

As our sales tend to be relatively lower and expenses can be relatively higher in the first half of the fiscal year, our total income, total expenses, profit and profit margin can experience seasonal fluctuations. Accordingly, our results for any particular period within a fiscal year may not necessarily be indicative of our results for a full fiscal year. See “*Management’s Discussion and Analysis of Financial Condition and Results of Operations-Seasonality*” on page 386.

59. ***We have presented certain supplemental information of our performance and liquidity which is not prepared under or required under Ind AS.***

This Red Herring Prospectus includes our Net Worth, Return on Net Worth, Net Asset Value per Equity Share, EBITDA, EBITDA Growth, EBITDA Margin, PAT Margin, Tangible Net Worth, Capital Employed, Return on Capital Employed, Capital Expenditure, Return on Equity, Debt to Equity Ratio, Net Debt and Net Debt to EBITDA (collectively “**Non-GAAP Measures**”) and certain other industry measures related to our operations and financial performance, which are supplemental measures of our performance and liquidity and are not required by, or presented in accordance with, Ind AS, IFRS or U.S. GAAP. For further details in relation to reconciliation of non-GAAP measures, see “*Other Financial Information*” on page 372.

Further, these Non-GAAP Measures and industry measures are not a measurement of our financial performance or liquidity under Ind AS, IFRS or U.S. GAAP and should not be considered in isolation or construed as an alternative to cash flows, profit/ (loss) for the years/ period or any other measure of financial performance or as an indicator of our operating performance, liquidity, profitability or cash flows generated by operating, investing or financing activities derived in accordance with Ind AS, IFRS or U.S. GAAP. In addition, such Non-GAAP Measures and industry measures are not standardized terms, and may vary from any standard methodology that is applicable across the Indian financial services industry, and therefore may not be comparable with financial or industry related statistical information of similar nomenclature computed and presented by other companies, and hence a direct comparison of these Non-GAAP Measures and industry measures between companies may not be possible. Other companies may calculate these Non-GAAP Measures and industry measures differently from us, limiting its usefulness as a comparative measure. Although such Non-GAAP Measures and industry measures are not a measure of performance calculated in accordance with applicable accounting standards, our Company’s management believes that they are useful to an investor in evaluating us as they are widely used measures to evaluate a company’s operating performance.

60. ***Significant differences exist between Ind AS and other accounting principles, such as US GAAP and International Financial Reporting Standards (“IFRS”), which investors may be more familiar with and consider material to their assessment of our financial condition.***

Our restated consolidated statements of assets and liabilities as at March 31, 2021, March 31, 2022, March 31, 2023, June 30, 2022 and June 30, 2023, and restated consolidated statements of profit and loss (including other comprehensive income), cash flows and changes in equity for Fiscals 2021, 2022 and 2023 and three months ended June 30, 2022 and June 30, 2023 have been prepared in accordance with the Indian Accounting Standards notified under Section 133 of the Companies Act, 2013, read with the Ind AS Rules and restated in accordance with the SEBI ICDR Regulations, the SEBI Circular and the Prospectus Guidance Note.

We have not attempted to quantify the impact of US GAAP, IFRS or any other system of accounting principles on the financial data included in this Red Herring Prospectus, nor do we provide a reconciliation of our financial statements to those of US GAAP, IFRS or any other accounting principles. US GAAP and IFRS differ in significant respects from

Ind AS. Accordingly, the degree to which the Restated Consolidated Financial Information included in this Red Herring Prospectus will provide meaningful information is entirely dependent on the reader's level of familiarity with Ind AS and the SEBI ICDR Regulations. Any reliance by persons not familiar with Indian accounting practices on the financial disclosures presented in this Red Herring Prospectus should accordingly be limited.

EXTERNAL RISK FACTORS

61. ***Slowdown in sectors that we sell to such as the real estate sector, and any adverse changes in the conditions affecting these markets can adversely impact our business, results of operations, financial condition and cash flows.***

Because the primary uses of our products include real estate construction, our business is dependent to a significant extent on the performance and growth of the sectors where we are present, particularly the real estate sector. As almost all homebuyers financing their purchase through mortgage financing, any change in mortgage interest rate, or any change in regulation with respect to mortgage loan could materially and adversely affect demands for housing. In the event of a downturn in the real estate sector or any of the other key sectors in which we are present, demand for their products may decline and to that extent, our business, financial condition, results of operations and cash flows could be adversely affected.

62. ***Changes in trade policies may adversely affect our profitability.***

There have been on-going discussions and commentary regarding changes to Indian trading policies, treaties and tariffs, which could create uncertainties about the future relationship between India and other countries with respect to trade policies, treaties and tariffs. Any such change in policies by India, such as the lapse of anti-dumping duty on polyvinyl chloride imports from China in 2022, and any such changes by the countries, in terms of tariff and non-tariff barriers, from which our suppliers import their raw materials, components and/or countries to which we export our products, may increase our operating costs, reduce our margins and make it more difficult for us to compete in the Indian and overseas markets, and our business, financial condition and results of operation could be severely impacted.

63. ***We may be affected by competition law in India and any adverse application or interpretation of the Competition Act could in turn adversely affect our business.***

The Competition Act was enacted for the purpose of preventing practices that have or are likely to have an adverse effect on competition in India and has mandated the Competition Commission of India to regulate such practices. Under the Competition Act, any arrangement, understanding or action, whether formal or informal, which causes or is likely to cause an appreciable adverse effect on competition is void and attracts substantial penalties.

Further, any agreement among competitors which, directly or indirectly, involves determination of purchase or sale prices, limits or controls production, or shares the market by way of geographical area or number of subscribers in the relevant market is presumed to have an appreciable adverse effect in the relevant market in India and shall be void. The Competition Act also prohibits abuse of a dominant position by any enterprise. On March 4, 2011, the Central Government notified and brought into force the Competition Commission of India (Procedure in regard to the transaction of business relating to combinations) Regulations ("**Combination Regulations**") under the Competition Act with effect from June 1, 2011. The Combination Regulations require acquisitions of shares, voting rights, assets or control or mergers or amalgamations that cross the prescribed asset and turnover based thresholds to be mandatorily notified to, and pre-approved by, the Competition Commission of India. Additionally, on May 11, 2011, the Competition Commission of India issued the Competition Commission of India (Procedure for Transaction of Business Relating to Combinations) Regulations, 2011, which sets out the mechanism for implementation of the merger control regime in India. The Competition Act aims to, among other things, prohibit all agreements and transactions which may have an appreciable adverse effect in India. Consequently, all agreements entered into by us could be within the purview of the Competition Act. Further, the Competition Commission of India has extraterritorial powers and can investigate any agreements, abusive conduct or combination occurring outside of India if such agreement, conduct or combination has an appreciable adverse effect in India. However, the impact of the provisions of the Competition Act on the agreements entered into by us cannot be predicted with certainty at this stage. We do not have any outstanding notices in relation to non-compliance with the Competition Act or the agreements entered into by us.

The Government of India has also introduced the Competition (Amendment) Bill, 2023 in the Lok Sabha on February 8, 2023, which has proposed several amendments to Competition (Amendment) Bill, 2022 introduced in the Lok Sabha in August, 2022 and the Competition Act. These amendments include the introduction of deal value thresholds for assessing whether a merger or acquisition qualifies as a "combination", expedited merger review timelines, codification of the lowest standard of "control" and enhanced penalties for providing false information or a failure to provide material information. As these are draft amendments, we cannot ascertain at this stage whether the proposed amendments will come into force in the form suggested or at all, their applicability, partially or at all, in respect of our operations once they come into force, or the extent to which the amendments, if and when they come into force, will result in additional costs for compliance, which in turn may adversely affect our business, results of operations, cash flows and prospects.

However, if we are affected, directly or indirectly, by the application or interpretation of any provision of the Competition Act, or any enforcement proceedings initiated by the Competition Commission of India, or any adverse publicity that may be generated due to scrutiny or prosecution by the Competition Commission of India or if any prohibition or substantial penalties are levied under the Competition Act, it would adversely affect our business.

64. ***Changing laws, rules and regulations and legal uncertainties, including the withdrawal of certain benefits or adverse application of tax laws, may adversely affect our business, prospects, results of operations and cash flows. Further, failure to comply with the existing laws and regulations applicable to our business could subject our Company to enforcement actions and penalties and otherwise harm our business.***

In India, our business is governed by various laws and regulations including, amongst others, the Bureau of Indian Standards Act, 2016, The Electrical Wires, Cables, Appliances and Protection Devices and Accessories (Quality Control) Order, 2003, The Legal Metrology Act, 2009, the Indian Stamp Act, 1899, the Maharashtra Stamp Act, 1958, the Indian Registration Act, 1908, the Environment (Protection) Act, 1986, Water (Prevention and Control of Pollution) Act, 1974, Air (Prevention and Control of Pollution) Act, 1981, The Noise Pollution (Regulation & Control) Rules, 2000, Hazardous and Other Wastes (Management and Transboundary Movement) Rules, 2016, various laws relating to employment and the Consumer Protection Act, 1986. For details, see “*Key Regulations and Policies*” beginning on page 229. Any failure or alleged failure to comply with the applicable laws, regulations or requirements could subject us to inspection, enforcement actions and penalties imposed by authorities.

For instance, in past there have been delays in reporting of foreign investment in our Company under applicable foreign investment laws. With respect to the allotments of (a) CCPS pursuant to the Scheme of Amalgamation in 2020 and (b) Equity Shares by way of bonus issue on March 20, 2023, although our Company had filed the form FC-GPR and have paid the late submission fees as specified by the RBI, our Company is yet to receive acknowledgments from the RBI for payment of late submission fees. Further, there have been delays in employees’ provident fund (“**EPF**”) payments in the past, due to, inter alia, technical issues faced while making the payment and delays in giving effect to the salary increments received by our employees that came into effect in prior periods. There have also been delayed fillings in relation to GST returns in the past, due to, inter alia, negative liability in central goods and services tax and state goods and services tax and a mismatch in the input tax credit amount

Our business could be adversely affected by any change in laws, municipal plans or interpretation of existing laws, or promulgation of new laws, rules and regulations applicable to us. For instance, starting from January 1, 2023, the manufacturers of ceiling fans in India are mandated by the revised norms issued by the Bureau of Energy Efficiency, Ministry of Power, Government of India to comply with the Bureau of Energy Efficiency’s Standards and Labeling program. Pursuant to the revised norms, the manufacturers are required to display on their products the energy efficiency star label assigned to such product by the Bureau of Energy Efficiency, and the products should have at least achieved one star energy efficiency rating. We cannot assure you that we will be able to comply with the revised norms or any other additional regulation applicable to us, or pass any cost arising from the compliance with the revised norms by the Bureau of Energy Efficiency to our consumers, and if we are not able to do so, our business, financial condition and prospects may be adversely affected.

Any political instability in India, such as corruption, scandals and protests against certain economic reforms, which have occurred in the past, could slow the pace of liberalization and deregulation. The rate of economic liberalization could change, and specific laws and policies affecting foreign investment, currency exchange rates and other matters affecting investment in India could change as well.

There can be no assurance that the Government of India may not implement new regulations and policies which will require us to obtain approvals and licenses from the Government of India and other regulatory bodies or impose onerous requirements and conditions on our operations. Any such changes and the related uncertainties with respect to the applicability, interpretation and implementation of any amendment or change to governing laws, regulation or policy in the jurisdictions in which we operate may have a material adverse effect on our business, financial condition, results of operations and cash flows. In addition, we may have to incur expenditures to comply with the requirements of any new regulations, which may also materially harm our results of operations and cash flows. Any unfavorable changes to the laws and regulations applicable to us could also subject us to additional liabilities.

In addition, unfavorable changes in or interpretations of existing, or the promulgation of new laws, rules and regulations including foreign investment laws governing our business, operations and group structure could result in us being deemed to be in contravention of such laws or may require us to apply for additional approvals. We may incur increased costs and other burdens relating to compliance with such new requirements, which may also require significant management time and other resources, and any failure to comply may adversely affect our business, results of operations, cash flows and prospects. Uncertainty in the applicability, interpretation or implementation of any amendment to, or change in, governing law, regulation or policy, including by reason of an absence, or a limited body, of administrative or judicial precedent may be time consuming as well as costly for us to resolve and may affect the viability of our current business or restrict our ability to grow our business in the future.

65. ***Regulation of greenhouse gas emissions and climate change issues may adversely affect our operations.***

Many governments are moving to enact climate change legislation and treaties at the international, national, state, provincial and local levels. Where legislation already exists, regulations relating to emission levels and energy efficiency are generally becoming more stringent. Some of the costs associated with meeting more stringent regulations can be offset by increased energy efficiency and technological innovation. However, if the current regulatory trend continues, meeting more stringent regulations is anticipated to result in increased costs, and this may have a material adverse impact on our financial condition and results of operations. Further, India and many other nations are signatories to international agreements related to climate change including the 1992 United Nations Framework Convention on Climate Change, which is intended to limit or capture emissions of greenhouse gas, such as carbon dioxide and the 2016 Paris Agreement, which extended the potentially binding set of emissions targets to all nations. Our compliance with any new environmental laws or regulations, particularly relating to greenhouse gas emissions, may require significant capital expenditure or result in the incurrence of fees and other penalties in the event of non-compliance. We cannot guarantee that future legislative, regulatory, international law, industry, trade or other developments will not negatively impact our operations and the demand for the products we sell. If any of the foregoing were to occur, our business, financial condition and results of operations may be adversely affected.

66. ***Our business is substantially affected by prevailing economic, political and other conditions.***

We are incorporated in and substantially all our operations are located in India. As a result, we are highly dependent on prevailing economic conditions in India and our results of operations and cash flows are significantly affected by factors influencing the Indian economy. Factors that may adversely affect the Indian economy, and hence our results of operations and cash flows, may include:

- any increase in Indian interest rates or inflation;
- any exchange rate fluctuations;
- any scarcity of credit or other financing in India, resulting in an adverse impact on economic conditions in India and scarcity of financing for our expansions;
- prevailing income conditions among Indian consumers and Indian corporates;
- volatility in, and actual or perceived trends in trading activity on India's principal stock exchanges;
- changes in India's tax, trade, fiscal or monetary policies;
- political instability, terrorism or military conflict in India or in countries in the region or globally, including in India's various neighboring countries;
- occurrence of natural or man-made disasters;
- prevailing regional or global economic conditions, including in India's principal export markets;
- any downgrading of India's debt rating by a domestic or international rating agency;
- financial instability in financial markets; and
- other significant regulatory or economic developments in or affecting India or its construction sector.

On February 24, 2022, Russian military forces invaded Ukraine. Although the length, impact and outcome of the ongoing military conflict in Ukraine is highly unpredictable, this conflict and responses from international communities could lead to significant market and other disruptions, including significant volatility in commodity prices and supply of energy resources, instability in financial markets, supply chain interruptions, political and social instability, changes in consumer or purchaser preferences as well as increase in cyberattacks and espionage.

To date, we have not experienced any material interruptions in our supply chain, manufacturing facility and distribution network in connection with this conflicts. We have no way to predict the progress or outcome of the conflict in Ukraine as the conflict, and any resulting government reactions, are rapidly developing and beyond our control. The extent and duration of the military action, sanctions and resulting market disruptions could be significant and could potentially have a substantial impact on the global economy and our business for an unknown period of time. Any of the abovementioned factors could affect our business, financial condition and results of operations.

In addition, any slowdown or perceived slowdown in the Indian economy, or in specific sectors of the Indian economy, could adversely affect our business, results of operations, cash flows and financial condition and the price of the Equity Shares.

67. ***Terrorist attacks, communal disturbances, civil unrest and other acts of violence or war involving India and other countries in which we have operations may adversely affect the financial markets and our business.***

Terrorist attacks and other acts of violence or war may negatively affect the Indian markets on which our Equity Shares trade and also adversely affect markets in which we have operations, as well as the worldwide financial markets. These acts may also result in a loss of business confidence, and adversely affect our business. In addition, any deterioration in relations between India and its neighboring countries might result in investor concern about stability in the region, which may adversely affect the price of our Equity Shares.

Some states in India have also witnessed civil unrest including communal disturbances in recent years and it is possible that future civil unrest, as well as other adverse social, economic and political events in India may have a negative impact on us. Such incidents may also create a greater perception that investment in Indian companies involves a higher degree of risk and may have an adverse impact on our business and the price of our Equity Shares.

68. ***Any downgrading of India's debt rating by an independent agency may harm our ability to raise financing.***

Any adverse revisions to India's credit ratings for domestic and international debt by domestic or international rating agencies may adversely affect our ability to raise additional financing and the interest rates and other commercial terms on which such additional financing is available. This could have a material adverse effect on our capital expenditure plans, business and financial performance and the price of our Equity Shares.

69. ***If the rate of Indian price inflation increases, our business and results of operations may be adversely affected.***

In the recent past, India has experienced fluctuating wholesale price inflation as compared to historical levels due to the global economic downturn. An increase in inflation in India could cause a rise in the price of raw materials and wages, or any other expenses that we incur. If this trend continues, we may be unable to accurately estimate or control our costs of production or pass on increase in costs to our customers and this could have a material adverse effect on our business and results of operations.

70. ***Financial instability in Indian financial markets could adversely affect our results of operations and financial condition.***

The Indian financial market and the Indian economy are influenced by economic and market conditions in other countries, particularly in the emerging market in Asian countries. Financial turmoil in Asia, Europe, the United States and elsewhere in the world in recent years has affected the Indian economy. Although economic conditions are different in each country, investors' reactions to developments in one country can have a material adverse effect on the securities of companies in other countries, including India. A loss in investor confidence in the financial systems of other emerging markets may cause increased volatility in Indian financial markets and, indirectly, in the Indian economy in general. Any global financial instability, including continued volatility in global financial markets due to the economic slowdown in China and the increase in the federal interest rates by the United States Federal Reserve, could also have a negative impact on the Indian financial markets and economy.

71. ***Any future issuance of Equity Shares may dilute your shareholding and sale of our Equity Shares by our Promoters or other major shareholders may adversely affect the trading price of the Equity Shares.***

Any future equity issuances by us, including a primary offering, may lead to the dilution of investors' shareholdings in our Company. Any future equity issuances by us or sales of our Equity Shares by our Promoters may adversely affect the trading price of the Equity Shares, which may lead to other adverse consequences for us including difficulty in raising debt-financing. In addition, any perception by investors that such issuances or sales might occur may also affect the trading price of our Equity Shares.

72. ***Holders of Equity Shares may be restricted in their ability to exercise pre-emptive rights under Indian law and thereby suffer future dilution of their ownership position.***

Under the Companies Act, a company incorporated in India must offer its equity shareholders pre-emptive rights to subscribe and pay for a proportionate number of equity shares to maintain their existing ownership percentages prior to issuance of any new equity shares, unless the pre-emptive rights have been waived by the adoption of a special resolution by shareholders of such company.

However, if the law of the jurisdiction that you are in does not permit the exercise of such pre-emptive rights without our filing an offering document or registration statement with the applicable authority in such jurisdiction, you will be unable to exercise such pre-emptive rights, unless we make such a filing. To the extent that you are unable to exercise pre-emptive rights granted in respect of the Equity Shares, your proportional interests in our Company may be reduced.

73. ***The Equity Shares have never been publicly traded, and, after the Offer, the Equity Shares may experience price and volume fluctuations, and an active trading market for the Equity Shares may not develop. Further, the price of***

the Equity Shares may be volatile, and you may be unable to resell the Equity Shares at or above the Offer Price, or at all.

Prior to the Offer, there has been no public market for the Equity Shares, and an active trading market on the Stock Exchanges may not develop or be sustained after the Offer. Listing and quotation does not guarantee that a market for the Equity Shares will develop, or if developed, the liquidity of such market for the Equity Shares. The Offer Price of the Equity Shares is proposed to be determined through a book-building process and may not be indicative of the market price of the Equity Shares at the time of commencement of trading of the Equity Shares or at any time thereafter. The market price of the Equity Shares may be subject to significant fluctuations in response to, among other factors, variations in operating results of our Company, market conditions specific to the industry we operate in, developments relating to India, volatility in securities markets in jurisdictions other than India, variations in the growth rate of financial indicators, variations in revenue or earnings estimates by research publications, and changes in economic, legal and other regulatory factors.

74. *Investors may be subject to stamp duty on transfer and taxes arising out of capital gains on the sale of the Equity Shares.*

Under current Indian tax laws, unless specifically exempted, capital gains arising from the sale of equity shares held as investments in an Indian company are generally taxable in India. Any capital gain realized on the sale of listed equity shares on a Stock Exchange held for more than 12 months immediately preceding the date of transfer will be subject to long term capital gains in India at the specified rates depending on certain factors, such as whether the sale is undertaken on or off the Stock Exchanges, the quantum of gains and any available treaty relief. Accordingly, the Investors may be subject to payment of long-term capital gains tax in India, in addition to payment of Securities Transaction Tax, on the sale of any Equity Shares held for more than 12 months immediately preceding the date of transfer. Securities Transaction Tax will be levied on and collected by a domestic stock exchange on which the Equity Shares are sold. Further, any capital gains realized on the sale of listed equity shares held for a period of 12 months or less immediately preceding the date of transfer will be subject to short-term capital gains tax in India.

Capital gains arising from the sale of the Equity Shares will not be chargeable to tax in India in cases where relief from such taxation in India is provided under a treaty between India and the country of which the seller is resident and the seller is entitled to avail benefits thereunder. Generally, Indian tax treaties do not limit India's ability to impose tax on capital gains. As a result, residents of other countries may be liable for tax in India as well as in their own jurisdiction on a gain upon the sale of the Equity Shares. We cannot predict whether any tax laws or other regulations impacting it will be enacted or predict the nature and impact of any such laws or regulations or whether, if at all, any laws or regulations would have an adverse effect our business, financial condition and results of operations.

75. *Investors may not be able to enforce judgments obtained in foreign courts against us.*

We are a public limited company under the laws of India. Many of our directors and officers are Indian nationals and all or a significant portion of the assets of all of the directors and officers and a substantial portion of our assets are located in India. As a result, it may be difficult for investors to effect service of process outside India on us or on such directors or officers or to enforce judgments against them obtained from courts outside India, including judgments predicated on the civil liability provisions of the United States federal securities laws.

India has reciprocal recognition and enforcement of judgments in civil and commercial matters with only a limited number of jurisdictions, which includes the United Kingdom, United Arab Emirates, Singapore and Hong Kong. In order to be enforceable, a judgment from a jurisdiction with reciprocity must meet certain requirements of the Indian Code of Civil Procedure, 1908 (the "Civil Code"). The Civil Code only permits the enforcement of monetary decrees, not being in the nature of any amounts payable in respect of taxes, other charges, fines or penalties. Judgments or decrees from jurisdictions which do not have reciprocal recognition with India cannot be enforced by proceedings in execution in India. Therefore, a final judgment for the payment of money rendered by any court in a non-reciprocating territory for civil liability, whether or not predicated solely upon the general laws of the non-reciprocating territory, would not be enforceable in India. Even if an investor obtained a judgment in such a jurisdiction against us, our officers or directors, it may be required to institute a new proceeding in India and obtain a decree from an Indian court. However, the party in whose favor such final judgment is rendered may bring a fresh suit in a competent court in India based on a final judgment that has been obtained in a non-reciprocating territory within three years of obtaining such final judgment. It is unlikely that an Indian court would award damages on the same basis or to the same extent as was awarded in a final judgment rendered by a court in another jurisdiction if the Indian court believed that the amount of damages awarded was excessive or inconsistent with public policy in India. In addition, any person seeking to enforce a foreign judgment in India is required to obtain prior approval of the Reserve Bank of India to repatriate any amount recovered pursuant to the execution of the judgment.

76. *Foreign investors are subject to foreign investment restrictions under Indian law, which may adversely affect the market price of the Equity Shares.*

Under the exchange control regulations currently in force in India, transfers of shares between non-residents and residents are freely permitted (subject to certain restrictions) if they comply with the pricing guidelines and reporting

requirements specified by the Reserve Bank of India. If the transfer of shares is not in compliance with such pricing guidelines or reporting requirements or falls under any of the exceptions referred to above, then the approval of the Reserve Bank of India will be required for such transaction to be valid.

Additionally, shareholders who seek to convert Rupee proceeds from a sale of shares in India into foreign currency and repatriate that foreign currency from India require a no-objection or a tax clearance certificate from the Indian income tax authorities. Further, in accordance with Press Note No. 3 (2020 Series), dated April 17, 2020 issued by the Department for Promotion of Industry and Internal Trade, Ministry of Commerce and Industry, Government of India (formerly known as Department of Industrial Policy and Promotion) and the Foreign Exchange Management (Non-debt Instruments) Amendment Rules, 2020 which came into effect from April 22, 2020, any investment, subscription, purchase or sale of equity instruments by entities of a country which shares a land border with India or where the beneficial owner of an investment into India is situated in or is a citizen of any such country, will require prior approval of the Government of India, as prescribed in the Consolidated FDI Policy and the FEMA Rules. These investment restrictions shall also apply to subscribers of offshore derivative instruments. Neither the Consolidated FDI Policy nor the FEMA Rules provide a definition of the term “beneficial owner”. The interpretation of “beneficial owner” and enforcement of this regulatory change may differ in practice, which may have an adverse effect on our ability to raise foreign capital. We cannot assure you that any required approval from the Reserve Bank of India or any other governmental agency can be obtained on any particular terms or at all.

77. *QIBs and Non-Institutional Investors are not permitted to withdraw or lower their Bids (in terms of quantity of Equity Shares or the Bid Amount) at any stage after submitting a Bid, and Retail Individual Investors are not permitted to withdraw their Bids after Bid/Offer Closing Date.*

Pursuant to the SEBI ICDR Regulations, Qualified Institutional Buyers and Non-Institutional Investors are required to pay the Bid Amount on submission of the Bid and are not permitted to withdraw or lower their Bids (in terms of quantity of Equity Shares or the Bid Amount) at any stage after submitting a Bid. Similarly, Retail Individual Investors can revise or withdraw their Bids at any time during the Bid/Offer Period and until the Bid/Offer Closing Date, but not thereafter. Therefore, Qualified Institutional Buyers and Non-Institutional Investors will not be able to withdraw or lower their Bids following adverse developments in international or national monetary policy, financial, political or economic conditions, our business, results of operations or otherwise at any stage after the submission of their Bids.

78. *Pursuant to listing of the Equity Shares, we may be subject to pre-emptive surveillance measures like Additional Surveillance Measure (“ASM”) and Graded Surveillance Measures (“GSM”) by the Stock Exchanges in order to enhance market integrity and safeguard the interest of investors.*

SEBI and the Stock Exchanges have introduced various pre-emptive surveillance measures in order to enhance market integrity and safeguard the interests of investors, including ASM and GSM. ASM and GSM are imposed on securities of companies based on various objective criteria such as significant variations in price and volume, concentration of certain client accounts as a percentage of combined trading volume, average delivery, securities which witness abnormal price rise not commensurate with financial health and fundamentals such as earnings, book value, fixed assets, net worth, price / earnings multiple, market capitalization etc.

Upon listing, the trading of our Equity Shares would be subject to differing market conditions as well as other factors which may result in high volatility in price, low trading volumes, and a large concentration of client accounts as a percentage of combined trading volume of our Equity Shares. The occurrence of any of the abovementioned factors or other circumstances may trigger any of the parameters prescribed by SEBI and the Stock Exchanges for placing our securities under the GSM and/or ASM framework or any other surveillance measures, which could result in significant restrictions on trading of our Equity Shares being imposed by SEBI and the Stock Exchanges. These restrictions may include requiring higher margin requirements, requirement of settlement on a trade for trade basis without netting off, limiting trading frequency, reduction of applicable price band, requirement of settlement on gross basis or freezing of price on upper side of trading, as well as mentioning of our Equity Shares on the surveillance dashboards of the Stock Exchanges. The imposition of these restrictions and curbs on trading may have an adverse effect on market price, trading and liquidity of our Equity Shares and on the reputation and conditions of our Company.

SECTION III: INTRODUCTION

THE OFFER

The following table summarizes the Offer details:

Offer of Equity Shares	Up to [●] Equity Shares aggregating up to ₹[●] million
of which	
Fresh Issue ⁽¹⁾	Up to [●] Equity Shares aggregating up to ₹1,800.00 million
Offer for Sale ⁽¹⁾⁽²⁾	Up to 17,236,808 Equity Shares aggregating up to ₹[●] million
The Offer consists of:	
(i) Employee Reservation Portion ⁽³⁾	Up to [●] Equity Shares, aggregating to ₹108.00 million
(ii) Net Offer	Up to [●] Equity Shares, aggregating to ₹[●] million
The Net offer comprises of:	
A) QIB Portion ⁽⁴⁾⁽⁵⁾	Not more than [●] Equity Shares, aggregating to ₹[●] million
of which:	
Anchor Investor Portion ⁽⁴⁾	Up to [●] Equity Shares
Net QIB Portion (assuming Anchor Investor Portion is fully subscribed)	[●] Equity Shares
of which:	
Available for allocation to Mutual Funds only (5% of the Net QIB Portion) ⁽⁵⁾	[●] Equity Shares
Balance of the Net QIB Portion for all QIBs including Mutual Funds	[●] Equity Shares
B) Non-Institutional Portion ⁽⁴⁾	Not less than [●] Equity Shares, aggregating to ₹[●] million
One-third of the Non-Institutional Portion available for allocation to Bidders with an application size of more than ₹0.20 million to ₹1.00 million	[●] Equity Shares
Two-third of the Non-Institutional Portion available for allocation to Bidders with an application size of more than ₹1.00 million	[●] Equity Shares
C) Retail Portion ⁽⁴⁾	Not less than [●] Equity Shares, aggregating to ₹[●] million
Pre-Offer and post-Offer Equity Shares	
Equity Shares outstanding prior to the Offer prior to the conversion of the Preference Shares	95,696,296 Equity Shares
Equity Shares outstanding prior to the Offer post conversion of the Preference Shares	111,068,856 Equity Shares
Equity Shares outstanding after the Offer	[●] Equity Shares
Use of Proceeds	For details on the use of the Net Proceeds, see “ <i>Objects of the Offer</i> ” beginning on page 113.

⁽¹⁾ The Offer (including the Fresh Issue) has been authorized by our Board of Directors pursuant to the resolutions passed at their meeting dated February 13, 2023 and our Shareholders pursuant to the resolution passed at their meeting held on March 20, 2023. Our Board has taken on record the consent of the Selling Shareholders to participate in the Offer for Sale pursuant to a resolution passed in its meeting held on May 5, 2023. In the event of under-subscription in the Offer, subject to receiving minimum subscription for 90% of the Fresh Issue and compliance with Rule 19(2)(b) of the Securities Contracts (Regulation) Rules, 1957, the Allotment for the valid Bids will be made in the first instance towards subscription for 90% of the Fresh Issue. If there remain any balance valid Bids in the Offer, the Allotment for the balance valid Bids will be made towards the sale of the Offered Shares being offered by the Selling Shareholders and only thereafter, towards the balance Fresh Issue. For avoidance of doubt, the balance Equity Shares of the Fresh Issue (i.e., 10% of the Fresh Issue) will be offered only once the entire portion of the Offered Shares are Allotted in the Offer.

⁽²⁾ The Equity Shares being offered by the Selling Shareholders have been held for a period of at least one year immediately preceding the date of filing this Red Herring Prospectus with SEBI or are otherwise eligible for being offered for sale pursuant to the Offer in terms of the SEBI ICDR Regulations. The Selling Shareholders have confirmed and authorized their participation in the Offer for Sale as set out below:

Selling Shareholders	Number of Offered Shares	Date of corporate authorisation/board resolution	Date of consent letter
Mahendrakumar Rameshwarlal Kabra	Up to 754,417 Equity Shares	N.A.	May 5, 2023
Hemant Mahendrakumar Kabra	Up to 754,417 Equity Shares	N.A.	May 5, 2023
Sumeet Mahendrakumar Kabra	Up to 754,417 Equity Shares	N.A.	August 31, 2023
Kabel Buildcon Solutions Private Limited	Up to 707,200 Equity Shares	March 18, 2023	May 5, 2023
Ram Ratna Wires Limited	Up to 1,364,480 Equity Shares	April 12, 2023	May 5, 2023
TPG Asia VII SF Pte. Ltd.	Up to 12,901,877 Equity Shares	March 9, 2023	August 31, 2023

⁽³⁾ In the event of under-subscription in the Employee Reservation Portion, the unsubscribed portion will be available for allocation and Allotment, proportionately to all Eligible Employees who have Bid in excess of ₹0.20 million, subject to the maximum value of Allotment made to such Eligible Employee not exceeding ₹0.50 million (net of Employee Discount). The unsubscribed portion, if any, in the Employee Reservation Portion (after allocation

up to ₹0.50 million, net of Employee Discount), shall be added to the Net Offer. Further, an Eligible Employee Bidding in the Employee Reservation Portion can also Bid under the Net Offer and such Bids will not be treated as multiple Bids. The Employee Reservation Portion shall not exceed 5% of our post-Offer paid-up Equity Share capital. For further details, see “Offer Structure” beginning on page 433. Our Company and the Investor Selling Shareholder may, in consultation with the BRLMs, offer an Employee Discount of up to [●]% to the Offer Price (equivalent of ₹[●] per Equity Share), which shall be announced two Working Days prior to the Bid/Offer Opening Date.

- (4) Subject to valid bids being received at or above the Offer Price, under subscription, if any, in any category, except in the QIB Portion, would be allowed to be met with spill-over from any other category or combination of categories of Bidders at the discretion of our Company and the Investor Selling Shareholder, in consultation with the Book Running Lead Managers, and the Designated Stock Exchange, subject to applicable laws.
- (5) Our Company and the Investor Selling Shareholder shall, in consultation with the Book Running Lead Managers, allocate up to 60% of the QIB Portion to Anchor Investors on a discretionary basis in accordance with the SEBI ICDR Regulations. One-third of the Anchor Investor Portion shall be reserved for domestic Mutual Funds only, subject to valid Bids being received from domestic Mutual Funds at or above the Anchor Investor Allocation Price. Further, 5% of the Net QIB Portion shall be available for allocation on a proportionate basis to Mutual Funds only, and the remainder of the Net QIB Portion shall be available for allocation on a proportionate basis to all QIB Bidders other than Anchor Investors, including Mutual Funds, subject to valid Bids being received at or above the Offer Price. In the event of under-subscription in the Anchor Investor Portion, the remaining Equity Shares shall be added to the Net QIB Portion. The Net QIB Portion shall be available for allocation on a proportionate basis to all QIB Bidders other than Anchor Investors, including Mutual Funds, subject to valid Bids being received at or above the Offer Price. For details, see “Offer Procedure” beginning on page 436.

Allocation to Bidders in all categories except the Anchor Investor Portion, Non-Institutional Portion and the Retail Portion, if any, shall be made on a proportionate basis subject to valid Bids received at or above the Offer Price.

The allocation to each of the RIBs shall not be less than the minimum Bid Lot, subject to availability of Equity Shares in the Retail Portion and the remaining available Equity Shares, if any, shall be allocated on a proportionate basis. The allocation to each of the NIIs shall not be less than the minimum application size, subject to the availability of Equity Shares in Non-Institutional Portion, and the remaining Equity Shares, if any, shall be allocated on a proportionate basis in accordance with the SEBI ICDR Regulations. For further details, see “Offer Procedure” beginning on page 436.

For details of the terms of the Offer, see “Terms of the Offer” beginning on page 427.

SUMMARY OF RESTATED CONSOLIDATED FINANCIAL INFORMATION

The following tables provide the summary of financial information of our Company derived from the Restated Consolidated Financial Information as at and for the three months period ended June 30, 2023 and June 30, 2022 and for the Financial Years ended March 31, 2023, March 31, 2022 and March 31, 2021.

The Restated Consolidated Financial Information referred to above are presented under “Financial Information” beginning on page 269. The summary of financial information presented below should be read in conjunction with the “Restated Consolidated Financial Information” and “Management’s Discussion and Analysis of Financial Condition and Results of Operations” beginning on pages 269 and 379, respectively.

(The remainder of this page is intentionally left blank)

SUMMARY OF RESTATED CONSOLIDATED STATEMENT OF ASSETS AND LIABILITIES

(₹ in million)

Particulars	As at June 30, 2023	As at June 30, 2022	As at March 31, 2023	As at March 31, 2022	As at March 31, 2021
ASSETS					
Non-current assets					
Property, plant and equipment	4,538.70	4,301.96	4,488.25	3,837.06	3,859.90
Capital work-in-progress	497.40	318.25	435.78	423.08	66.81
Right of use assets	663.61	398.91	618.46	111.17	81.48
Other intangible assets	54.26	96.81	64.86	36.65	52.75
Intangible assets under development	-	-	-	6.00	4.85
Investment accounted for using equity method	200.39	206.16	196.29	216.36	171.43
Financial assets					
Investments	919.46	357.59	581.05	405.57	234.58
Loans	1.99	0.39	2.87	0.52	0.96
Other financial assets	61.29	21.63	35.76	21.72	15.90
Income tax assets (net)	118.37	151.71	118.34	133.72	52.35
Other non-current assets	349.32	105.57	333.35	65.99	143.34
	7,404.79	5,958.98	6,875.01	5,257.84	4,684.35
Current assets					
Inventories	8,592.78	8,779.49	8,601.77	7,096.21	5,340.56
Financial assets					
Investments	2,792.08	2,006.99	2,849.23	2,054.74	1,960.20
Trade receivables	6,315.23	5,384.47	5,918.73	5,171.46	4,203.64
Cash and cash equivalents	151.41	67.07	310.35	123.00	83.96
Bank balances other than cash and cash equivalents	-	-	500.40	-	0.70
Loans	5.20	4.48	0.60	2.20	6.48
Other financial assets	176.31	88.34	89.69	118.97	34.74
Other current assets	1,005.33	1,174.45	1,190.43	682.02	836.51
	19,038.34	17,505.29	19,461.20	15,248.60	12,466.79
Total assets	26,443.13	23,464.27	26,336.21	20,506.44	17,151.14
EQUITY AND LIABILITIES					
Equity					
Equity share capital	478.48	239.24	478.48	239.24	239.24
Instrument entirely equity in nature	4,151.86	4,151.86	4,151.86	4,151.86	4,151.86
Other equity	10,608.74	8,411.08	9,566.61	8,111.93	6,075.21
	15,239.08	12,802.18	14,196.95	12,503.03	10,466.31
Liabilities					
Non-current liabilities					
Financial liabilities					
Borrowings	187.49	511.92	268.59	593.13	712.82
Lease liabilities	613.88	358.26	564.05	82.27	52.64
Other financial liabilities	21.89	19.23	21.29	-	-
Provisions	153.70	82.25	140.81	71.72	60.44
Deferred tax liabilities (net)	191.04	125.84	148.67	131.04	78.87
Other non-current liabilities	0.08	0.13	0.09	0.09	0.18
	1,168.08	1,097.63	1,143.50	878.25	904.95
Current liabilities					
Financial liabilities					
Borrowings	3,850.16	4,518.00	4,889.82	4,617.98	4,274.31
Lease liabilities	83.42	48.67	81.95	32.51	30.66
Trade payables					
total outstanding dues of micro enterprises and small enterprises	308.29	161.01	458.81	110.99	93.22
total outstanding dues of creditors other than micro enterprises and small enterprises	4,218.88	3,643.79	3,942.48	1,567.75	1,041.81
Other financial liabilities	380.87	324.15	377.72	240.49	164.82
Other current liabilities	725.28	643.89	958.72	415.45	120.42
Provisions	239.53	224.95	221.92	139.99	54.64
Income tax liabilities (net)	229.54	-	64.34	-	-
	10,035.97	9,564.46	10,995.76	7,125.16	5,779.88
Total equity and liabilities	26,443.13	23,464.27	26,336.21	20,506.44	17,151.14

SUMMARY OF RESTATED CONSOLIDATED STATEMENT OF PROFIT AND LOSS

(₹ in million, except per share data)

Particulars	For the period ended June 30, 2023	For the period ended June 30, 2022	For the year ended March 31, 2023	For the year ended March 31, 2022	For the year ended March 31, 2021
Revenue from operations	15,973.14	12,359.10	55,992.00	43,859.36	27,239.41
Other income	162.84	73.90	344.40	462.82	219.95
Total Income	16,135.98	12,433.00	56,336.40	44,322.18	27,459.36
Expenses					
Cost of materials consumed	11,971.13	10,401.30	43,697.88	35,755.15	21,731.99
Purchases of stock-in-trade	923.35	964.38	3,688.53	1,566.17	1,298.64
Changes in inventories of finished goods, stock-in-trade, work-in-progress and scrap	160.83	(940.95)	(1,629.40)	(1,241.50)	(1,538.45)
Employee benefits expense	767.69	611.75	2,641.59	1,888.53	1,483.45
Finance costs	144.24	80.77	420.86	232.84	270.56
Depreciation and amortization expense	160.87	144.82	596.27	460.84	447.50
Other expenses	1,020.65	922.87	4,370.20	2,858.53	1,962.31
Total expenses	15,148.76	12,184.94	53,785.93	41,520.56	25,656.00
Profit before share of profit of joint venture and tax	987.22	248.06	2,550.47	2,801.62	1,803.36
Add: Share of profit/(loss) of joint venture net of tax	6.66	(1.83)	9.44	41.97	10.98
Profit before tax	993.88	246.23	2,559.91	2,843.59	1,814.34
Tax expense:					
Current tax	247.25	64.15	658.32	648.27	489.12
Short/(excess) provision of tax of earlier years	-	-	3.87	2.99	(7.89)
Deferred tax charge / (credit)	3.15	0.66	(1.00)	52.96	(20.87)
	250.40	64.81	661.19	704.22	460.36
Profit for the year/period	743.48	181.42	1,898.72	2,139.37	1,353.98
Other comprehensive income/(loss)					
A) Items that will not be reclassified to profit and loss					
a) (i) Re-measurement of post employment benefits obligation	(1.14)	(1.81)	(4.54)	(7.23)	4.04
(ii) Income tax relating to items that will not be reclassified to profit and loss	0.29	0.46	1.14	1.82	(1.02)
b) (i) Fair value gain/(loss) on investment in equity instrument through OCI	338.40	(47.97)	175.49	170.98	80.55
(ii) Income tax relating to items that will not be reclassified to profit and loss	(39.51)	5.40	(19.77)	(1.03)	(6.99)
B) Items that will be reclassified to profit or loss					
a) Exchange difference arising on translation of foreign operation	(2.57)	(8.37)	(29.51)	2.96	(4.70)
Total other comprehensive income/ (loss) (net of tax)	295.47	(52.29)	122.81	167.50	71.88
Total comprehensive income for the year/period	1,038.95	129.13	2,021.53	2,306.87	1,425.86
Earnings per Equity Share (face value of ₹ 5 each)*					
Basic	6.69	1.63	17.09	19.26	12.19
Diluted	6.68	1.63	17.07	19.22	12.18

*Not annualized for the period ended June 30, 2023 and June 30, 2022.

SUMMARY OF RESTATED CONSOLIDATED STATEMENT OF CASH FLOWS

(₹ in million)

Particulars	For the period ended June 30, 2023	For the period ended June 30, 2022	For the year ended March 31, 2023	For the year ended March 31, 2022	For the year ended March 31, 2021
(A) CASH FLOWS FROM OPERATING ACTIVITIES:					
Profit before tax	993.88	246.23	2,559.91	2,843.59	1,814.34
Adjustments for :					
Depreciation and amortization expense	160.87	144.82	596.27	460.84	447.50
Property, plant and equipment write off	0.25	-	0.83	-	-
Grant related to property, plant and equipment	(0.01)	(0.97)	(1.01)	(36.92)	(0.04)
Share of (profit)/loss from joint venture	(6.66)	1.83	(9.44)	(41.97)	(10.98)
Finance costs	144.24	80.77	420.87	232.83	270.56
Employees share based payment expenses	3.18	2.86	5.04	7.52	-
Interest income	(8.41)	(2.67)	(30.72)	(9.67)	(32.89)
Dividend income	-	-	(7.06)	(1.41)	(0.71)
Gain on sale of mutual fund investments	(7.67)	(0.41)	(8.70)	(0.04)	-
Fair value gain on investment on mutual fund	(38.47)	(12.04)	(104.34)	(94.53)	(40.02)
Allowance for / (reversal) of expected credit loss on trade receivables(net)	2.90	(7.31)	9.14	(18.07)	52.91
Bad debts	0.23	-	-	10.60	-
Reversal of provision on advances to vendor	-	(19.26)	(19.26)	-	-
Provisions for warranty expenses	12.61	78.64	96.49	75.25	21.68
Unrealised foreign exchange loss/(gain)	(28.95)	64.47	78.60	60.89	23.06
Gain on sale of property, plant and equipment	-	-	(0.80)	(20.28)	(0.87)
	1,227.99	576.96	3,585.82	3,468.63	2,544.54
Adjustments for:					
(Increase) in trade receivables	(603.63)	(34.61)	(179.30)	(959.53)	(114.70)
(Increase)/decrease in financial assets	(89.00)	(7.00)	(25.69)	(82.71)	10.02
(Increase)/decrease in other assets	135.78	(403.62)	(428.69)	164.02	(424.34)
(Increase)/decrease in inventories	8.99	(976.53)	(798.79)	(1,755.66)	(1,588.45)
Increase /(decrease) in trade payables	128.23	1,816.90	2,401.13	540.67	(667.60)
Increase /(decrease) in financial liabilities	12.54	8.96	41.02	(69.23)	(7.47)
Increase /(decrease) in other liabilities and provision	38.46	577.68	524.42	408.13	(44.05)
Cash generated from/(used in) operations	859.36	1,558.74	5,119.92	1,714.32	(292.05)
Income taxes paid (net of refund)	(82.09)	(82.14)	(582.46)	(732.62)	(418.52)
Net cash generated from/(used in) operating activities (A)	777.27	1,476.60	4,537.46	981.70	(710.57)
(B) CASH FLOWS FROM INVESTING ACTIVITIES					
Purchases of property, plant and equipment including payments towards capital advance and capital creditors	(252.19)	(228.69)	(1,083.48)	(682.25)	(474.21)
Proceeds from sale of property, plant and equipment	-	6.48	5.32	47.18	9.64
Refund of Share application money - Joint Venture	-	-	-	-	0.82
(Investment in)/Proceed from fixed deposits with banks	476.71	(2.40)	(506.63)	(2.30)	398.67
Purchase of home electrical business, net of cash acquired	-	(1,095.82)	(1,095.82)	-	-
(Investment in) / Redemption of mutual fund (net)	103.30	60.21	(681.46)	0.04	(32.00)
Dividend received from investments in quoted equity shares	-	-	7.06	1.41	0.71
Interest received	18.94	2.40	20.04	9.37	37.57
Net cash generated / (used in) Investing activities (B)	346.76	(1,257.82)	(3,334.97)	(626.55)	(58.80)
(C) CASH FLOWS FROM FINANCING ACTIVITIES					
Proceeds from non current borrowing	-	-	-	338.00	350.00
Repayment of non current borrowing	(81.10)	(100.53)	(382.02)	(75.78)	(151.32)
Proceeds from/(repayment) of short term borrowing (net)	(1,036.59)	(84.54)	318.40	(38.51)	863.07
Finance costs paid	(130.06)	(73.53)	(355.47)	(222.23)	(287.46)
Repayment of lease obligations	(35.22)	(16.11)	(96.24)	(39.92)	(33.04)
Dividend paid	-	-	(499.81)	(277.67)	-
Net cash (used in) / generated from financing activities (C)	(1,282.97)	(274.71)	(1,015.14)	(316.11)	741.25

Particulars	For the period ended June 30, 2023	For the period ended June 30, 2022	For the year ended March 31, 2023	For the year ended March 31, 2022	For the year ended March 31, 2021
(D) Net increase/(decrease) in cash and cash equivalents (A+B+C)	(158.94)	(55.93)	187.35	39.04	(28.12)
Add : Cash and cash equivalents as at the beginning of the period/year	310.35	123.00	123.00	83.96	112.08
Cash and cash equivalents as at the end of the period/year	151.41	67.07	310.35	123.00	83.96

Note :

- a) The above Statement of Cash Flows has been prepared under the "Indirect Method" as set out in the Indian Accounting Standard (Ind AS 7) Statement of Cash Flows.
- b) Cash and cash equivalents

(₹ in million)

Particulars	As at June 30, 2023	As at June 30, 2022	As at March 31, 2023	As at March 31, 2022	As at March 31, 2021
Cash on hand	0.36	0.32	0.37	0.33	0.51
Balance with banks	151.05	66.75	121.98	72.67	83.45
Term deposits (with original maturity of 3 months or less)	-	-	188.00	50.00	-
Cash and cash equivalents in Statement of Cash Flows	151.41	67.07	310.35	123.00	83.96

GENERAL INFORMATION

Registered Office of our Company

R R Kabel Limited
Ram Ratna House
Victoria Mill Compound
Pandurang Budhkar Marg
Worli, Mumbai 400 013
Maharashtra, India

For details in relation to the changes in the registered office of our Company, see “*History and Certain Corporate Matters – Changes in our Registered Office*” on page 235.

Corporate Office of our Company

R R Kabel Limited
Alembic Business Park (West)
Ground Floor, Bhailal Amin Marg
Gorwa, Vadodara 390 003
Gujarat, India

Corporate Identity Number: U28997MH1995PLC085294

Registration Number: 085294

Address of the RoC

Our Company is registered with the RoC situated at the following address

Registrar of Companies
100, Everest, Marine Drive
Mumbai 400 002
Maharashtra, India

Board of Directors of our Company

Details regarding our Board as on the date of this Red Herring Prospectus are set forth below:

Name	Designation	DIN	Address
Tribhuvanprasad Rameshwarlal Kabra	Executive Chairman	00091375	Uma Sadan, 178, Vinayak Society, Akota, Vadodara 390 020, Gujarat, India
Shreegopal Rameshwarlal Kabra	Managing Director	00140598	9th & 10th Floor, Ishan Building, Plot No. 547, Jame Jamshed Road, Matunga CR, Mumbai 400 019, Maharashtra, India
Mahendrakumar Rameshwarlal Kabra	Joint Managing Director	00473310	Flat No. 1908, Tower 2, Casa Grande, 20th Floor, Senapati Bapat Marg, Lower Parel, Delisle Road, Mumbai 400 013, Maharashtra, India
Mitesh Daga	Non-Executive Nominee Director ⁽¹⁾	08189217	F-2302, Oberoi Splendor, JVLR, Opp. Majas Bus Depot, Jogeshwari East, Mumbai 400 060, Maharashtra, India
Bhagwat Singh Babel	Independent Director	01476935	221, Ameya, behind Sagar Darshan Apartment, near Vidya Bhavan School, Devali, Udaipur 313 001, Rajasthan, India
Ramesh Chandak	Independent Director	00026581	Tower No.- 5, Flat No. 2901, Crescent Bay, Jerbai Wadia Road, Parel, Mumbai 400 012, Maharashtra, India
Vipul Sabharwal	Independent Director	03429263	House no. 9218, DLF Phase - 4, Gurgaon 122 001, Haryana, India
Jyoti Davar	Independent Director	09757889	A – 2A, Swarn Singh Road, Adarsh Nagar, Delhi 110 033, Delhi, India

(1) Nominee of TPG Asia VII SF Pte. Ltd.

For further details of our Board, see “*Our Management*” beginning on page 243.

Company Secretary and Compliance Officer

Himanshu Navinchandra Parmar is our Company Secretary and Compliance Officer. His contact details are as follows:

Himanshu Navinchandra Parmar

Alembic Business Park (West),
Ground Floor, Bhailal Amin Marg,
Gorwa, Vadodara 390 003
Gujarat, India
Tel: +91 265683 0800
E-mail ID: investorrelations.rrkl@rrglobal.com

Book Running Lead Managers

Axis Capital Limited

1st Floor, Axis House
C-2, Wadia International Centre
Pandurang Budhkar Marg, Worli,
Mumbai 400 025, Maharashtra, India
Tel: +91 22 4325 2183
E-mail: rrkabel.ipo@axiscap.in
Investor grievance ID: complaints@axiscap.in
Website: www.axiscapital.co.in
Contact person: Pratik Pednekar
SEBI registration no.: INM000012029

Citigroup Global Markets India Private Limited

1202, 12th Floor, First International Financial Centre G Block,
Bandra Kurla Complex, Bandra (East) Mumbai 400 098,
Maharashtra, India
Tel: +91 22 6175 9999
E-mail: rrkabel.ipo@citi.com
Investor grievance ID: investors.cgimib@citi.com
Website:
www.online.citibank.co.in/rhtm/citigroupglobalscreen1.htm
Contact person: Vedika Chitnis
SEBI registration no: INM000010718

HSBC Securities and Capital Markets (India) Private Limited

52/60, Mahatma Gandhi Road
Fort, Mumbai 400 001, Maharashtra, India
Tel: +91 22 6864 1289
E-mail: rrkabelipo@hsbc.co.in
Investor grievance ID: investor grievance@hsbc.co.in
Website: <https://www.business.hsbc.co.in/en-gb/regulations/hsbc-securities-and-capital-market>
Contact person: Sumant Sharma/ Vipin Jha
SEBI registration no: INM000010353

JM Financial Limited

7th Floor, Cnergy
Appasaheb Marathe Marg
Prabhadevi, Mumbai 400 025
Maharashtra, India
Tel: +91 22 6630 3030
E-mail: rrkabel.ipo@jmfl.com
Investor grievance ID: grievance.ibd@jmfl.com
Website: www.jmfl.com
Contact person: Prachee Dhuri
SEBI registration no.: INM000010361

Legal Counsel to the Issuer

Cyril Amarchand Mangaldas

5th Floor, Peninsula Chambers
Peninsula Corporate Park
Ganpatrao Kadam Marg
Mumbai 400 013
Maharashtra, India
Tel: +91 22 2496 4455

Registrar to the Offer

Link Intime India Private Limited

C 101, 1st Floor, 247 Park
L.B.S. Marg, Vikhroli (West)
Mumbai 400 083
Maharashtra, India
Tel: +91-022-810 811 4949
E-mail ID: rrkabel.ipo@linkintime.co.in
Website: www.linkintime.co.in
Investor grievance e-mail ID: rrkabel.ipo@linkintime.co.in
SEBI registration no: INR000004058
Contact person: Shanti Gopalkrishnan

Statutory Auditor to our Company

B S R & Co. LLP, Chartered Accountants

903, Commerce House V

Near Vodafone House
Pralhadnagar, Corporate Road
Ahmedabad 380 051, Gujarat, India
Tel: +91 79 7145 0001
E-mail ID: rupenshah2@bsraffiliates.com
Peer Review Number.: 014196
Firm Registration Number: 101248W/W-100022

There has been no change in the statutory auditors of our Company during the three years preceding the date of this Red Herring Prospectus.

Bankers to the Offer

Escrow Collection Bank, Refund Bank and Sponsor Bank

ICICI Bank Limited

Capital Market Division
5th Floor, HT Parekh Marg
Churchgate, Mumbai 400 020
Maharashtra, India
Tel: +91 022 6805 2182
Email: sagar.welekar@icicibank.com/ipocmg@icicibank.com
Website: www.icicibank.com
Contact person: Sagar Welekar

Public Offer Bank and Sponsor Bank

Axis Bank Limited

Axis House, 6th Floor
C-2, Wadia International Centre
Pandurang Budhkar Marg
Worli, Mumbai 400 025
Maharashtra, India
Tel: +91 022 2425 3672
Email: vishal.lade@axisbank.com
Website: www.axisbank.com
Contact person: Vishal M. Lade

Bankers to our Company

State Bank of India

3rd and 4th Floor, Mid Town Heights
Jetalpur Road, Vadodara 390 007
Gujarat, India
Tel: +91 0265 2303423
E-mail ID: sbi.01946@sbi.co.in

Standard Chartered Bank

1st Floor, Raindrops Building, C G Road
Opposite Cargo Ford Motors
Ahmedabad 380 009
Gujarat, India
Tel: +91 98253 00885
E-mail ID: Pradeep.bhatt@sc.com

Kotak Mahindra Bank

7th Floor, B –Wing, Venus Amadeus
Jodhpur Cross Roads, Ahmedabad 380 015
Gujarat, India
Tel: +91 079 67168701
E-mail ID: niraj.shah@kotak.com

HSBC Limited

Mardia Plaza, C.G. Road
Ahmedabad 380 006
Gujarat, India
Tel: +91 91369 49865

HDFC Bank Limited

Vasana Bhayli II Priya Talkies
Cross Road Branch, Ground Floor
Urban 2 Complex Opposite Akshar Pavillion
Vadodara 390 007
Gujarat, India
Tel: +91 265 719 1425
E-mail ID: rushabh.shah2@hdfcbank.com

Yes Bank Limited

7th Floor, B Block, Times Square Grand
Sindhu Bhavan Road, Thaltej
Ahmedabad 380 069
Gujarat, India
Tel: +91 79 6923 5116
E-mail ID: ashish.ranjan@yesbank.in

DBS Bank

Ground Floor, Express towers, Block III
Backbay Reclamation, Nariman Point
Mumbai 400 021
Maharashtra, India
Tel: +91 22 6629 7509
E-mail ID: anandsoochak@dbs.com

Citibank, N. A.

1st Floor, Kalapurnam

E-mail ID: vivek.j.agarwal@hsbc.co.in

ICICI Bank Limited

42, Haribhakti Society
Nr. Chakli Circle, O.P. Road
Vadodara 390 007
Gujarat, India

Tel: +91 0265 6722013

E-mail ID: puneet.kapoor@icicibank.com

Federal Bank Limited

GF Gokulesh – II
RC Dutt Road
Alkapuri, Baroda 390 007
Gujarat, India

Tel: +91 0265 2350941

E-mail ID: pragnesh@federalbank.co.in

Off C.G Road, Ahmedabad 380 009

Gujarat, India

Tel: +91 079 4001 5835

E-mail ID: birud.shah@citi.com

Axis Bank Limited

Wardhaman Complex, Race Course (North)
Opposite GEB, Vadodara 390 007
Gujarat, India

Tel: +91 98250 31212

E-mail ID: bharatt.kale@axisbank.com

IndusInd Bank Limited

3rd Floor Parker House
Nr Radisson Blue Hotel, Opp C.G.Road
Ahmedabad 380 009

Gujarat, India

Tel: +91 99091 83389

E-mail ID: jigar.shah@indusind.com

Syndicate Member

JM Financial Services Limited

Ground Floor, 2,3&4
Kamanwala Chambers, Sir P.M. Road
Fort, Mumbai 400 001
Maharashtra, India

Tel: +91 22 6136 3400

E-mail ID: tn.kumar@jmfl.com / sona.verghese@jmfl.com

Website: www.jmfinancialservices.in

Contact Person: T N Kumar/ Sona Verghese

Filing of this Red Herring Prospectus

A copy of the Draft Red Herring Prospectus has been filed electronically on the SEBI intermediary portal at <https://siportal.sebi.gov.in>, in accordance with the SEBI circular no. SEBI/HO/CFD/DIL1/CIR/P/2018/011 dated January 19, 2018 and at cfddil@sebi.gov.in in accordance with the instructions issued by the SEBI on March 27, 2020, in relation to “Easing of Operational Procedure – Division of Issues and Listing – CFD”, as specified in Regulation 25(8) of the SEBI ICDR Regulations. It will also be filed with the Securities and Exchange Board of India at:

Securities and Exchange Board of India

Corporation Finance Department
Division of Issues and Listing
SEBI Bhavan, Plot No. C4 A, ‘G’ Block
Bandra Kurla Complex, Bandra I
Mumbai 400 051, Maharashtra, India

Our Company is registered with the Registrar of Companies, Maharashtra at Mumbai. This Red Herring Prospectus and the Prospectus will be filed with RoC at its address, Registrar of Companies 100, Everest, Marine Drive, Mumbai 400 002 Maharashtra, India in accordance with Section 32 read with Section 26 of the Companies Act, along with the material contracts and documents referred to in this Red Herring Prospectus and the Prospectus with the RoC at its office and through electronic portal at: <http://www.mca.gov.in/mcafoportal/loginvalidateuser.do>.

Designated Intermediaries

Self-Certified Syndicate Banks

The list of recognised intermediaries notified by SEBI is available at <https://www.sebi.gov.in/sebiweb/other/OtherAction.do?doRecognisedFpi=yes&intmId=34>, or at such other website as may be prescribed by SEBI from time to time. A list of the Designated SCSB branches with which an ASBA Bidder (other than a UPI Bidder using the UPI Mechanism), not Bidding through Syndicate/Sub Syndicate or through a Registered Broker, RTA or CDP may submit the Bid cum Application Forms, is available at <https://www.sebi.gov.in/sebiweb/other/OtherAction.do?doRecognisedFpi=yes&intmId=34>, or at such other websites as may be prescribed by SEBI from time to time.

Self-Certified Syndicate Banks and mobile applications enabled for Unified Payments Interface Mechanism

In accordance with SEBI Circular No. SEBI/HO/CFD/DIL2/CIR/P/2019/76 dated June 28, 2019, SEBI Circular No. SEBI/HO/CFD/DIL2/CIR/P/2019/85 dated April 5, 2022, SEBI Circular No. SEBI/HO/CFD/DIL2/CIR/P/2022/45 dated April 5, 2022, read with other applicable UPI Circulars, UPI Bidders bidding through UPI Mechanism may apply through the SCSBs and mobile applications, using UPI handles, whose names appears on the SEBI website. A list of SCSBs and mobile applications, which, are live for applying in public issues using UPI mechanism is provided in the list available on the website of SEBI at www.sebi.gov.in/sebiweb/other/OtherAction.do?doRecognisedFpi=yes&intmId=43 and updated from time to time and at such other websites as may be prescribed by SEBI from time to time..

Syndicate Self-Certified Syndicate Banks' Branches

In relation to Bids (other than Bids by Anchor Investors and RIBs) submitted under the ASBA process to a member of the Syndicate, the list of branches of the SCSBs at the Specified Locations named by the respective SCSBs to receive deposits of Bid cum Application Forms from the members of the Syndicate is available on the website of the SEBI (<https://www.sebi.gov.in/sebiweb/other/OtherAction.do?doRecognisedFpi=yes&intmId=35>) and updated from time to time or any such other website as may be prescribed by SEBI from time to time.

Registered Brokers

Bidders (other than RIBs) can submit ASBA Forms in the Offer using the stockbroker network of the stock exchange, i.e. through the Registered Brokers at the Broker Centres. The list of the Registered Brokers, including details such as postal address, telephone number and e-mail address, is provided on the websites of the Stock Exchanges at <https://www.bseindia.com/> and <https://www.nseindia.com>, as updated from time to time.

Registrar and Share Transfer Agents

The list of the RTAs eligible to accept ASBA Forms (other than RIBs) at the Designated RTA Locations, including details such as address, telephone number and e-mail address, is provided on the websites of the Stock Exchanges at <https://www.bseindia.com/Static/PublicIssues/RtaDp.aspx> and <https://www.nseindia.com/products-services/initial-public-offerings-asba-procedures>, respectively, as updated from time to time.

Collecting Depository Participants

The list of the CDPs eligible to accept ASBA Forms at the Designated CDP Locations, including details such as name and contact details, is provided on the websites of the Stock Exchanges at <https://www.bseindia.com/Static/PublicIssues/RtaDp.aspx> and <https://www.nseindia.com/products-services/initial-public-offerings-asba-procedures>, respectively, as updated from time to time.

Experts to the Offer

Except as disclosed below, our Company has not obtained any expert opinions in connection with this Red Herring Prospectus:

Our Company has received a written consent dated September 6, 2023, from our Statutory Auditor, namely, B S R & Co. LLP, Chartered Accountants, to include their name as required under section 26(5) of the Companies Act, 2013 read with SEBI ICDR Regulations, in this RHP, and as an “expert” as defined under section 2(38) of the Companies Act, 2013 to the extent and in their capacity as our Statutory Auditor, and in respect of their (a) examination report dated August 30, 2023 on the Restated Consolidated Financial Information, and (b) report dated September 6, 2023, on the statement of special tax benefits. Such consent has not been withdrawn as on the date of this RHP. However, the term “expert” and “consent” shall not be construed to mean an “expert” and “consent” as defined under the U.S. Securities Act.

Our Company has received written consent dated August 28, 2023, from Vishvakarma Consultancy Services Private Limited, Chartered Engineer, to include their name as required under Section 26(5) of the Companies Act read with SEBI ICDR Regulations, in this Red Herring Prospectus and as an “expert”, as defined under Section 2(38) of the Companies Act, 2013 to the extent and in their capacity as an Independent Chartered Engineer, in relation to the certificate dated August 28, 2023, certifying, *inter alia*, the details of the installed and production capacity of our manufacturing facilities

Inter-se allocation of responsibilities among the Book Running Lead Managers to the Offer

The following table sets forth the inter-se allocation of responsibilities for various activities among the Book Running Lead Managers to the Offer:

Sr. No	Activities	Responsibility	Coordination
1.	Capital structuring with the relative components and formalities such as composition of debt and equity, type of instruments, and positioning strategy. Due diligence of Company including its operations / management / business plans / legal etc. Drafting and design of Draft Red Herring Prospectus, Red Herring Prospectus and Prospectus.	Axis, Citi, HSBC, JM	Axis

Sr. No	Activities	Responsibility	Coordination
	Ensure compliance and completion of prescribed formalities with the Stock Exchanges, SEBI and RoC including finalization of RHP, Prospectus, Offer Agreement, Syndicate and Underwriting Agreements and RoC filing		
2.	Drafting and approval of all statutory advertisements.	Axis, Citi, HSBC, JM	Axis
3.	Drafting and approval of all publicity material other than statutory advertisements as mentioned in point 2 above, including corporate advertising and brochures and filing of media compliance report with SEBI.	Axis, Citi, HSBC, JM	HSBC
4.	Appointment of intermediaries – Registrar to the Offer, advertising agency, Banker(s) to the Offer, Sponsor Bank, printer and other intermediaries including coordination of all agreements	Axis, Citi, HSBC, JM	Citi
5.	Preparation of roadshow presentation and FAQs for the road show team	Axis, Citi, HSBC, JM	Citi
6.	International institutional marketing of the Offer, which will cover, <i>inter alia</i> : <ul style="list-style-type: none"> • Institutional marketing strategy • Finalising the list and division of international investors for one- to-one meetings • Finalising international road show and investor meeting schedules 	Axis, Citi, HSBC, JM	HSBC
7.	Domestic Institutional marketing of the Offer, which will cover, <i>inter alia</i> : <ul style="list-style-type: none"> • Institutional marketing strategy preparation of publicity budget; • Finalizing the list and division of domestic investors for one- to-one meetings; and • Finalizing domestic road show and investor meeting schedule. <p>These will be done in consultation with & approval of the management and selling shareholders</p>	Axis, Citi, HSBC, JM	Axis
8.	Conduct non-institutional marketing of the Offer.	Axis, Citi, HSBC, JM	JM
9.	Conduct retail marketing of the Offer, which will cover, inter-alia: <ul style="list-style-type: none"> • Finalising media, marketing, public relations strategy and publicity budget • Finalising collection centres • Finalising centres for holding conferences for brokers etc. • Follow-up on distribution of publicity and Offer material including form, RHP/Prospectus and deciding on the quantum of the Offer material 	Axis, Citi, HSBC, JM	Axis
10.	Coordination with Stock Exchanges for book building software, bidding terminals and mock trading and Deposit of 1% security deposit with the designated stock exchange, anchor coordination, anchor CAN and intimation of anchor allocation and preparation of CAN for Anchor Investors.	Axis, Citi, HSBC, JM	HSBC
11.	Managing the book and finalization of pricing in consultation with Company and Selling Shareholders	Axis, Citi, HSBC, JM	Citi
12.	Post-Offer activities, which shall involve essential follow-up with Bankers to the Offer and SCSBs to get quick estimates of collection and advising Bank about the closure of the Offer, based on correct figure finalization of the basis of allotment based on technical rejections, post Offer stationery and, coordination with various agencies connected with the post-offer activity such as registrar to the offer, bankers to the offer, Sponsor Banks Self-Certified Syndicate Bank including responsibility for underwriting arrangements (as applicable), listing of instruments, demat credit and refunds/ unblocking of funds, announcement of allocation and dispatch of refunds to Bidders, etc., payment of the applicable STT on behalf of Selling Shareholders, coordination for investor complaints	Axis, Citi, HSBC, JM	JM

Sr. No	Activities	Responsibility	Coordination
	related to the Offer, Coordinating with Stock Exchanges and SEBI for submission of all post-Offer reports including the submission of final post issue report and coordination with SEBI and Stock Exchanges for refund of 1% security deposit		

IPO Grading

No credit rating agency registered with SEBI has been appointed for grading the Offer.

Monitoring Agency

Our Company has appointed ICRA Limited as the Monitoring Agency in accordance with Regulation 41 of the SEBI ICDR Regulations. The details of the Monitoring Agency are as follows:

ICRA Limited

B-710, Statesman House

148, Barakhamba Road

New Delhi 110 001

Tel: +91 011 2335 7940-45

Email ID: shivakumar@icraindia.com

Appraising Entity

None of the objects for which the Net Proceeds will be utilised have been appraised by any agency.

Credit Rating

As this is an Offer of Equity Shares, credit rating is not required.

Debenture Trustees

As this is an Offer of Equity Shares, the appointment of debenture trustees is not required.

Green Shoe Option

No green shoe option is contemplated under the Offer.

Book Building Process

Book building, in the context of the Offer, refers to the process of collection of Bids from bidders on the basis of this Red Herring Prospectus, the Bid Cum Application Forms and the Revision Forms, if any, within the Price Band and the minimum Bid Lot, which will be decided by our Company and the Investor Selling Shareholder in consultation with the Book Running Lead Managers, and will be advertised in all editions of English national daily newspaper, The Financial Express, all editions of Hindi national daily newspaper, Jansatta, and the Mumbai edition of the Marathi daily newspaper, Navshakti (Marathi being the regional language of Maharashtra, where our Registered Office is located) each with wide circulation at least two Working Days prior to the Bid/Offer Opening Date and shall be made available to the Stock Exchanges for the purpose of uploading on their respective websites. The Offer Price and discount (if any), shall be determined by our Company and the Investor Selling Shareholder in consultation with the Book Running Lead Managers, after the Bid/Offer Closing Date. For details, see “*Offer Procedure*” beginning on page 436.

All Bidders (other than Anchor Investors) shall participate in this Offer mandatorily through the ASBA process by providing the details of their respective bank accounts in which the corresponding Bid Amount will be blocked by the SCSBs. In addition to this, the UPI Bidders shall participate through the ASBA process by either (a) providing the details of their respective ASBA Account in which the corresponding Bid Amount will be blocked by the SCSBs; or (b) through the UPI Mechanism. Anchor Investors are not permitted to participate in the Offer through the ASBA process.

In terms of the SEBI ICDR Regulations, QIBs and Non-Institutional Investors are not permitted to withdraw their Bid(s) or lower the size of their Bid(s) (in terms of the number of Equity Shares or the Bid Amount) at any stage. RIBs and Eligible Employees Bidding in the Employee Reservation Portion can revise their Bid(s) during the Bid/ Offer Period and withdraw their Bid(s) until Bid/ Offer Closing Date. Anchor Investors are not allowed to withdraw their Bids after the Anchor Investor Bidding Date. Except for Allocation to RIBs, NIIs, Eligible Employees Bidding in the Employee Reservation Portion and the Anchor Investors, allocation in the Offer will be on a proportionate basis. Further, allocation to Anchor Investors will be on a discretionary basis.

Each Bidder by submitting a Bid in the Offer, will be deemed to have acknowledged the above restrictions and the terms of the Offer.

For further details, see “Terms of the Offer”, “Offer Structure” and “Offer Procedure” beginning on pages 427, 433 and 436, respectively.

The process of Book Building under the SEBI ICDR Regulations and the Bidding Process are subject to change from time to time and the investors are advised to make their own judgment about investment through this process prior to submitting a Bid in the Offer.

Bidders should note that, the Offer is also subject to obtaining (i) the final approval of the RoC after the Prospectus is filed with the RoC; and (ii) final listing and trading approvals of the Stock Exchanges, which our Company shall apply for after Allotment.

Underwriting Agreement

After the determination of the Offer Price and allocation of Equity Shares, but prior to the filing of the Prospectus with the RoC, our Company and the Selling Shareholders will enter into an Underwriting Agreement with the Underwriters for the Equity Shares proposed to be offered through the Offer. The Underwriting Agreement is dated [●]. Pursuant to the terms of the Underwriting Agreement, the obligations of each of the Underwriters will be several and will be subject to certain conditions specified therein.

The Underwriters have indicated their intention to underwrite the following number of Equity Shares:

(The Underwriting Agreement has not been executed as on the date of this Red Herring Prospectus. This portion has been intentionally left blank and will be filled in before filing of the Prospectus with the RoC.)

Name, address, telephone number and e-mail address of the Underwriters	Indicative number of Equity Shares to be underwritten	Amount underwritten (in ₹ million)
[●]	[●]	[●]
[●]	[●]	[●]
[●]	[●]	[●]
[●]	[●]	[●]

The aforementioned underwriting commitments are indicative and will be finalised after the Offer Price is determined and allocation of Equity Shares in accordance with provisions of Regulation 40(2) of the SEBI ICDR Regulations.

In the opinion of our Board of Directors (based on representations made to our Company by the Underwriters), the resources of the aforementioned Underwriters are sufficient to enable them to discharge their respective underwriting obligations in full. The aforementioned Underwriters are registered with SEBI under Section 12(1) of the SEBI Act or registered as brokers with the Stock Exchanges. Our Board of Directors/ IPO Committee, at its meeting held on [●], has approved the acceptance and entered into the Underwriting Agreement mentioned above on behalf of our Company.

Allocation among the Underwriters may not necessarily be in proportion to their underwriting commitment set forth in the table above.

Notwithstanding the above table, the Underwriters shall be severally responsible for ensuring payment with respect to the Equity Shares allocated to investors respectively procured by them in accordance with the Underwriting Agreement. In the event of any default in payment, the respective Underwriter, in addition to other obligations defined in the Underwriting Agreement, will also be required to procure purchasers for or purchase the Equity Shares to the extent of the defaulted amount in accordance with the Underwriting Agreement.

CAPITAL STRUCTURE

The share capital of our Company as on the date of this Red Herring Prospectus is set forth below:

(in ₹, except share data)

	Aggregate value at face value	Aggregate value at Offer Price*
A AUTHORISED SHARE CAPITAL⁽¹⁾		
120,000,000 Equity Shares (having face value of ₹5 each)	600,000,000.00	-
3,843,140 Preference Shares (having face value of ₹1,080.33 each)	4,151,859,437.00	-
Total	4,751,859,437.00	-
B ISSUED, SUBSCRIBED AND PAID-UP SHARE CAPITAL BEFORE THE OFFER		
111,068,856 Equity Shares (having face value of ₹5 each)	555,344,280.00	[●]
C PRESENT OFFER IN TERMS OF THIS RED HERRING PROSPECTUS⁽²⁾		
Offer of up to [●] Equity Shares aggregating up to ₹[●] million ⁽²⁾⁽³⁾	[●]	[●]
of which		
Fresh Issue of up to [●] Equity Shares aggregating up to ₹1,800.00 million ⁽²⁾	[●]	[●]
Offer for Sale of up to 17,236,808 Equity Shares aggregating up to ₹[●] million ⁽³⁾	86,184,040	[●]
Which includes:		
Employee Reservation Portion of up to [●] Equity Shares aggregating up to ₹108.00 million ⁽⁴⁾	[●]	[●]
Net Offer of up to [●] Equity Shares aggregating up to ₹[●] million	[●]	[●]
D ISSUED, SUBSCRIBED AND PAID-UP SHARE CAPITAL AFTER THE OFFER		
[●] Equity Shares (having face value of ₹5 each)	[●]	-
E SECURITIES PREMIUM ACCOUNT		
Before the Offer (in million) (as on date of this Red Herring Prospectus)		4,075.00
After the Offer (in million)		[●]

* To be included upon finalisation of the Offer Price.

- (1) For details in relation to the changes in the authorised share capital of our Company in the last 10 years, see "History and Certain Corporate Matters – Amendments to our Memorandum of Association" on page 236.
- (2) The Offer has been authorized by a resolution of our Board of Directors at their meeting held on February 13, 2023, the Fresh Issue has been authorised by a special resolution passed by our Shareholders at their meeting held on March 20, 2023. Each of the Selling Shareholders have severally and not jointly, specifically confirmed and authorised their respective participation in the Offer for Sale pursuant to their respective consent letters. For further details, see "Other Regulatory and Statutory Disclosures" beginning on page 409.
- (3) Each of the Selling Shareholders confirms that the Equity Shares being offered by each of the Selling Shareholders have been held by such Selling Shareholder for a period of at least one year prior to the date of filing of this Red Herring Prospectus with SEBI or are otherwise eligible for being offered for sale pursuant to the Offer in terms of the SEBI ICDR Regulations. For details of authorisations for the Offer for Sale, see "Other Regulatory and Statutory Disclosures" beginning on page 409.
- (4) Eligible Employees Bidding in the Employee Reservation Portion must ensure that the maximum Bid Amount does not exceed ₹0.50 million (net of Employee Discount). However, the initial Allotment to an Eligible Employee in the Employee Reservation Portion shall not exceed ₹0.20 million. Only in the event of an under-subscription in the Employee Reservation Portion post the initial Allotment, such unsubscribed portion may be Allotted on a proportionate basis to Eligible Employees Bidding in the Employee Reservation Portion, for a value in excess of ₹0.20 million, subject to the total Allotment to an Eligible Employee not exceeding ₹0.50 million (net of Employee Discount). Our Company and the Investor Selling Shareholder in consultation with the BRLMs, may offer an Employee Discount of up to [●]% to the Offer Price (equivalent of ₹[●] per Equity Share) to Eligible Employee(s) Bidding in the Employee Reservation Portion, subject to necessary approvals as may be required, and which shall be announced at least two Working Days prior to the Bid / Offer Opening Date. Our Company and the Investor Selling Shareholder may, in consultation with the BRLMs, offer an Employee Discount of up to [●]% to the Offer Price (equivalent of ₹[●] per Equity Share), which shall be announced two Working Days prior to the Bid/Offer Opening Date.

Notes to the Capital Structure

1. Equity share capital history of our Company

The history of the Equity Share capital of our Company is set forth below:

Date of allotment of equity shares / Shareholders' resolution / buy-back	Nature of allotment/ buy-back	Nature of consideration	Number of equity shares	Face value per equity share (in ₹)	Issue price per equity share (in ₹)	Names of allottees/ shareholders
February 13, 1995	Initial subscription to the Memorandum of Association	Cash	700	10	10	Allotment of 100 equity shares each to Rameshwarlal Jagannath Kabra, Late Satyanarayan Loya, Mahendrakumar Rameshwarlal Kabra, Shreegopal Rameshwarlal Kabra, Kirtidevi Shreegopal Kabra, Late Ashok S. Loya and Late Dinesh Modani
April 15, 1995	Further issue	Cash	255,000	10	10	Allotment of 5,000 equity shares to Rameshwarlal Jagannath Kabra, 20,000 equity shares to Late Hemlata Kabra, 60,000 equity shares to Tribhuvanprasad Rameshwarlal Kabra and 170,000 equity shares to Kirtidevi Shreegopal Kabra
March 18, 1997	Further issue	Cash	80,000	10	10	Allotment of 80,000 equity shares to Mahendrakumar Rameshwarlal Kabra
February 11, 1998	Further issue	Cash	2,945,990	10	10	Allotment of 3,100 equity shares to Tribhuvanprasad Rameshwarlal Kabra, 10,000 equity shares to Tribhuvanprasad Kabra HUF, 20,000 equity shares to Mahendra Kumar Kabra HUF, 227,500 equity shares to Kabra Shreegopal Rameshwarlal HUF, 375,000 equity shares to Late Umadevi Tribhuvanprasad Kabra, 445,000 equity shares to Rameshwarlal Kabra HUF, 505,000 equity shares to Rajesh Shreegopal Kabra, 654,390 equity shares to Kirtidevi Shreegopal Kabra and 706,000 equity shares to Mahendrakumar Rameshwarlal Kabra
March 11, 1998	Further issue	Cash	850,000	10	10	Allotment of 20,000 equity shares to Mahendra Kumar Kabra HUF, 30,000 equity shares to Tribhuvanprasad Rameshwarlal Kabra, 50,000 equity shares to Rameshwarlal Jagannath Kabra, 80,000 equity shares to Mahhesh Tribhuvanprasad Kabra, 150,000 equity shares to Mahesh Enamelled Wires Private Limited (now known as MEW Electricals Limited), 150,000 equity shares to Ram Ratna Wires Limited, 170,000 equity shares to Rameshwarlal Kabra HUF and 200,000 equity shares to Shramik Winding Wires Private Limited (now known as Kabel Buildcon Solutions Private Limited)
May 31, 1998	Further issue	Cash	2,158,700	10	10	Allotment of 10,000 equity shares to Mahendra Kumar Kabra HUF, 25,000 equity shares to Mahhesh Tribhuvanprasad Kabra, 25,000 equity shares to Ratnidevi Rameshwarlal Kabra, 51,600 equity shares to Late Hemlata Kabra, 55,600 equity shares to Tribhuvanprasad Rameshwarlal Kabra, 100,000 equity shares to Mahesh Enamelled Wires Private Limited (now known as MEW Electricals Limited), 132,500 equity shares to Rameshwarlal Jagannath Kabra, 180,000

Date of allotment of equity shares / Shareholders' resolution / buy-back	Nature of allotment/ buy-back	Nature of consideration	Number of equity shares	Face value per equity share (in ₹)	Issue price per equity share (in ₹)	Names of allottees/ shareholders
						equity shares to Kabra Shreegopal Rameshwarlal HUF, 224,200 equity shares to Kirtidevi Shreegopal Kabra, 250,000 equity shares to Ram Ratna Wires Limited, 323,000 equity shares to Late Umadevi Tribhuvanprasad Kabra, 380,000 equity shares to Rameshwarlal Kabra HUF and 401,800 equity shares to Mahendrakumar Rameshwarlal Kabra
November 23, 1998	Further issue	Cash	1,569,610	10	10	Allotment of 12,500 equity shares to Hemant Mahendrakumar Kabra, 35,000 equity shares to Late Hemlata Kabra, 45,000 equity shares to Sumeet Mahendrakumar Kabra, 60,000 equity shares to Kabra Shreegopal Rameshwarlal HUF, 60,500 equity shares to Tribhuvanprasad Rameshwarlal Kabra, 93,500 equity shares to Ratnidevi Rameshwarlal Kabra, 95,000 equity shares to Shreegopal Rameshwarlal Kabra, 150,000 equity shares to Kirtidevi Shreegopal Kabra, 181,000 equity shares to Mahendrakumar Rameshwarlal Kabra, 182,000 equity shares to Rameshwarlal Jagannath Kabra, 261,510 equity shares to Rameshwarlal Kabra HUF and 393,600 equity shares to Late Umadevi Tribhuvanprasad Kabra
March 28, 2000	Further issue	Cash	614,500	10	10	Allotment of 102,000 equity shares to Rajesh Shreegopal Kabra, 227,100 equity shares to Late Umadevi Tribhuvanprasad Kabra and 285,400 equity shares to Mahendrakumar Rameshwarlal Kabra
January 15, 2001	Further issue	Cash	525,500	10	10	Allotment of 1,500 equity shares to Hemant Mahendrakumar Kabra, 1,610 equity shares to Kirtidevi Shreegopal Kabra, 3,500 equity shares to Ratnidevi Rameshwarlal Kabra, 5,000 equity shares to Mahesh Tribhuvanprasad Kabra, 30,500 equity shares to Rameshwarlal Jagannath Kabra, 110,000 equity shares to Tribhuvanprasad Kabra HUF, 161,390 equity shares to Rameshwarlal Kabra HUF and 212,000 equity shares to Tribhuvanprasad Rameshwarlal Kabra
February 27, 2003	Further issue	Cash	401,000	10	10	Allotment of 1,000 equity shares to Late Gangadevi Rathi, 5,000 equity shares to Late Satyanarayan Loya, 5,000 equity shares to Neha Loya, 10,000 equity shares to Gaurishankar Satyanarayan Loya HUF, 15,000 equity shares to Mamta Anant Loya, 20,000 equity shares to Anant S. Loya HUF, 67,500 equity shares to Mamta Ashok Loya, 102,500 equity shares to Late Ashok S. Loya and 175,000 equity shares to Gaurishankar Satyanarayan Loya
March 20, 2004	Further issue	Cash	554,000	10	10	Allotment of 9,000 equity shares to Ratnidevi Rameshwarlal Kabra, 15,000 equity shares to Late Ashok S. Loya, 40,000 equity shares to Satyanarayan Mohanlal Loya HUF, 100,000 equity shares to Mahesh Enamelled Wires Private Limited (now known as MEW

Date of allotment of equity shares / Shareholders' resolution / buy-back	Nature of allotment/ buy-back	Nature of consideration	Number of equity shares	Face value per equity share (in ₹)	Issue price per equity share (in ₹)	Names of allottees/ shareholders
						Electricals Limited), 130,000 equity shares to Late Umadevi Tribhuvanprasad Kabra, 130,000 equity shares to Mahendrakumar Rameshwarlal Kabra and 130,000 equity shares to Rajesh Shreegopal Kabra
March 31, 2004	Further issue	Cash	1,375,000	10	15	Allotment of 100,000 equity shares to Ram Ratna Research and Holdings Private Limited, 140,000 equity shares to Rameshwarlal Kabra HUF, 155,000 equity shares to Tribhuvanprasad Kabra HUF, 227,000 equity shares to Late Umadevi Tribhuvanprasad Kabra, 355,000 equity shares to Rajesh Shreegopal Kabra and 398,000 equity shares to Mahendrakumar Rameshwarlal Kabra
March 29, 2005	Further issue	Cash	432,500	10	15	Allotment of 3,300 equity shares to Saroj A. Loya, 11,000 equity shares to Mamta Ashok Loya, 13,300 equity shares to Sunita G. Loya, 51,500 equity shares to Late Satyanarayan Loya, 53,000 equity shares to Late Ashok S. Loya, 66,800 equity shares to Mahendrakumar Rameshwarlal Kabra, 66,800 equity shares to Shreegopal Rameshwarlal Kabra, 66,800 equity shares to Late Umadevi Tribhuvanprasad Kabra, and 100,000 equity shares to Kirtidevi Shreegopal Kabra
March 8, 2006	Further issue	Cash	2,897,500	10	20	Allotment of 1,500 equity shares to Anant S. Loya HUF, 1,500 equity shares to Gaurishankar Satyanarayan Loya, 1,500 equity shares to Neha Loya, 1,500 equity shares to Saroj A. Loya, 1,500 equity shares to Sunita G. Loya, 1,875 equity shares to Saraswatidevi Satyanarayan Loya, 2,055 equity shares to Nikunj A. Loya, 2,550 equity shares to Anuj A. Loya, 2,700 equity shares to Aditya G. Loya, 3,000 equity shares to Satyanarayan Mohanlal Loya HUF, 3,750 equity shares to Mamta Ashok Loya, 4,875 equity shares to Ashok S. Loya HUF, 5,250 equity shares to Ashish G. Loya, 23,170 equity shares to Kabra Shreegopal Rameshwarlal HUF, 25,000 equity shares to Late Hemlata Kabra, 25,000 equity shares to Rameshwarlal Kabra HUF, 34,500 equity shares to Late Ashok S. Loya, 50,000 equity shares to Tribhuvanprasad Rameshwarlal Kabra, 65,000 equity shares to Mahendra Kumar Kabra HUF, 67,500 equity shares to Sarita Jhwar, 80,000 equity shares to Mahesh Enamelled Wires Private Limited (now known as MEW Electricals Limited), 95,000 equity shares to Shreegopal Rameshwarlal Kabra, 100,000 equity shares to Kirtidevi Shreegopal Kabra, 100,000 equity shares to Ram Ratna Research and Holdings Private Limited, 181,000 equity shares to Mahendrakumar Rameshwarlal Kabra, 212,000 equity shares to Rajesh Shreegopal Kabra, 260,000 equity shares to Mahhesh Tribhuvanprasad Kabra, 605,775 equity shares to Hemant Mahendrakumar Kabra, and 940,000 equity

Date of allotment of equity shares / Shareholders' resolution / buy-back	Nature of allotment/ buy-back	Nature of consideration	Number of equity shares	Face value per equity share (in ₹)	Issue price per equity share (in ₹)	Names of allottees/ shareholders
						shares to Late Umadevi Tribhuvanprasad Kabra
March 30, 2007	Further issue	Cash	585,100	10	50	Allotment of 4,000 equity shares to Sunita G. Loya, 4,000 equity shares to Late Satyanarayan Loya, 10,000 equity shares to Rajesh Shreegopal Kabra, 12,000 equity shares to Kirtidevi Shreegopal Kabra, 20,000 equity shares to Shreegopal Rameshwarlal Kabra, 25,000 equity shares to Gaurishankar Satyanarayan Loya, 29,000 equity shares to Kabra Shreegopal Rameshwarlal HUF, 34,000 equity shares to Sarita Jhavar, 40,000 equity shares to Hemant Mahendrakumar Kabra, 45,600 equity shares to Anant S. Loya HUF, 60,000 equity shares to Mahhesh Tribhuvanprasad Kabra, 65,000 equity shares to Late Ashok S. Loya, 74,000 equity shares to Mamta Ashok Loya and 162,500 equity shares to Rameshwarlal Kabra HUF
November 28, 2007	Bonus issue in the ratio of 3:10	N.A.	4,573,530	10	-	Allotment of 30 equity shares to Late Dinesh Modani, 300 equity shares to Late Gangadevi Rathi, 563 equity shares to Saraswatidevi Satyanarayan Loya, 616 equity shares to Nikunj A. Loya, 765 equity shares to Anuj A. Loya, 810 equity shares to Aditya G. Loya, 1,440 equity shares to Saroj A. Loya, 1,462 equity shares to Ashok S. Loya HUF, 1,575 equity shares to Ashish G. Loya, 1,950 equity shares to Neha Loya, 3,000 equity shares to Gaurishankar Satyanarayan Loya HUF, 5,640 equity shares to Sunita G. Loya, 12,900 equity shares to Satyanarayan Mohanlal Loya HUF, 15,000 equity shares to Priti Amit Saboo, 18,180 equity shares to Late Satyanarayan Loya, 20,130 equity shares to Anant S. Loya HUF, 30,000 equity shares to Asha Muchhal, 30,450 equity shares to Sarita Jhavar, 39,300 equity shares to Ratnadevi Rameshwarlal Kabra, 39,480 equity shares to Late Hemlata Kabra, 51,375 equity shares to Mamta Ashok Loya, 58,500 equity shares to Sumeet Mahendrakumar Kabra, 60,000 equity shares to Ram Ratna Research and Holdings Private Limited, 60,000 equity shares to Shramik Winding Wires Private Limited (now known as, Kabel Buildcon Solutions Private Limited), 60,450 equity shares to Gaurishankar Satyanarayan Loya, 64,500 equity shares, Mahendra Kumar Kabra HUF, 81,030 equity shares to Late Ashok S. Loya, 82,500 equity shares to Tribhuvanprasad Kabra HUF, 83,070 equity shares to Shreegopal Rameshwarlal Kabra, 120,000 equity shares to Ram Ratna Wires Ltd., 120,030 equity shares to Rameshwarlal Jagannath Kabra, 129,000 equity shares to MEW Electricals Private Limited, 155,901 equity shares to Kabra Shreegopal Rameshwarlal HUF, 171,360 equity shares to Tribhuvanprasad Rameshwarlal Kabra, 174,000 equity shares to Mahhesh Tribhuvanprasad Kabra, 257,933 equity

Date of allotment of equity shares / Shareholders' resolution / buy-back	Nature of allotment/ buy-back	Nature of consideration	Number of equity shares	Face value per equity share (in ₹)	Issue price per equity share (in ₹)	Names of allottees/ shareholders
						shares to Hemant Mahendrakumar Kabra, 288,690 equity shares to Kirtidevi Shreegopal Kabra, 394,200 equity shares to Rajesh Shreegopal Kabra, 523,620 equity shares to Rameshwarlal Kabra HUF, 654,030 equity shares to Mahendrakumar Rameshwarlal Kabra and 759,750 equity shares to Late Umadevi Tribhuvanprasad Kabra
March 29, 2008	Further issue	Cash	327,370	10	110	Allotment of 100 equity shares to Anuj A. Loya, 100 equity shares to Aditya G. Loya, 150 equity shares to Nikunj A. Loya, 250 equity shares to Neha Loya, 400 equity shares to Ashish G. Loya, 500 equity shares to Saraswatidevi Satyanarayan Loya, 500 equity shares to Saroj A. Loya, 750 equity shares to Ashok S. Loya HUF, 750 equity shares to Mamta Ashok Loya, 1,000 equity shares to Satyanarayan Mohanlal Loya HUF, 2,719 equity shares to Kabra Shreegopal Rameshwarlal HUF, 7,945 equity shares to Sarita Jhavar, 8,000 equity shares to Anant S. Loya HUF, 9,500 equity shares to Late Ashok S. Loya, 12,926 equity shares to Kirtidevi Shreegopal Kabra, 68,180 equity shares to Rajesh Shreegopal Kabra, 90,000 equity shares to Sumeet Mahendrakumar Kabra and 123,600 equity shares to Shreegopal Rameshwarlal Kabra
October 25, 2008	Further issue	Cash	300,000	10	300	Allotment of 100,000 equity shares each to Oasis Realty Private Limited, Pepeyon Enterprises Private Limited and The Ambika Silk Mills Co. Limited
November 12, 2014	Allotment pursuant to the Scheme of Amalgamation 2014	Other than cash	3,700,000	10	N.A.	Allotment of 250 equity shares to Chhaya Ahuja, 250 equity shares to Vvidhi Mahhesh Kabra, 250 equity shares to Yash Kabra, 250 equity shares to Janvi Kabra, 250 equity shares to Rameshwarlal Jagannath Kabra, 500 equity shares to Sarita Jhavar, 750 equity shares to Mahendra Kumar Kabra HUF, 1,000 equity shares to Late Ashok S. Loya, 1,000 equity shares to Late Dinesh Modani, 1,000 equity shares to Priti Amit Saboo, 1,500 equity shares to Tribhuvanprasad Kabra HUF, 2,250 equity shares to Ratnidevi Rameshwarlal Kabra, 4,500 equity shares to Rameshwarlal Kabra HUF, 40,500 equity shares to Mahhesh Tribhuvanprasad Kabra, 113,250 equity shares to Sumeet Mahendrakumar Kabra, 116,250 equity shares to Tribhuvanprasad Rameshwarlal Kabra, 117,000 equity shares to Late Umadevi Tribhuvanprasad Kabra, 169,000 equity shares to Late Hemlata Kabra, 200,000 equity shares to Mahendrakumar Rameshwarlal Kabra, 281,750 equity shares to Kirtidevi Shreegopal Kabra, 287,500 equity shares to Hemant Mahendrakumar Kabra, 304,500 equity shares to Kabra Shreegopal Rameshwarlal HUF, 320,000 equity shares to Jag-Bid Finvest Private Limited, 364,000 equity shares to Shreegopal Rameshwarlal Kabra, 450,000 equity shares to Rajesh

Date of allotment of equity shares / Shareholders' resolution / buy-back	Nature of allotment/ buy-back	Nature of consideration	Number of equity shares	Face value per equity share (in ₹)	Issue price per equity share (in ₹)	Names of allottees/ shareholders
						Shreegopal Kabra and 922,500 equity shares to Ram Ratna Research and Holdings Private Limited. For details in relation to the scheme of amalgamation, see " <i>History and Certain Corporate Matters – Details regarding material acquisitions or divestments of business or undertakings, mergers, amalgamations or revaluation of assets in the last ten years</i> ", on page 238
September 11, 2018	Buy-back of equity shares	Cash	(750,724)	10	1,080.33	Bought back 414 equity shares from Anuj A. Loya, 610 equity shares from Aditya G. Loya, 1,740 equity shares from Saroj A. Loya, 2,938 equity shares from Saraswatidevi Satyanarayan Loya, 4,396 equity shares from Gaurishankar Satyanarayan Loya, 4,440 equity shares from Sunita G. Loya, 6,950 equity shares from Neha Loya, 7,087 equity shares from Ashok S. Loya HUF, 7,460 equity shares from Anant Satyanarayan Loya, 37,000 equity shares from Priti Amit Saboo, 47,014 equity shares from Shreegopal Rameshwarlal Kabra, 51,000 equity shares from Rajesh Shreegopal Kabra, 61,000 equity shares from Kirtidevi Shreegopal Kabra, 83,200 equity shares from Kabel Buildcon Solutions Private Limited, 113,323 equity shares from Mahendrakumar Rameshwarlal Kabra, 143,272 equity shares from Tribhuvanprasad Rameshwarlal Kabra and 178,880 equity shares from Ram Ratna Wires Limited
December 23, 2020	Allotment pursuant to the Scheme of Amalgamation 2020	Other than cash	528,798	10	N.A.	Allotment of 44 equity shares to Tribhuvanprasad Rameshwarlal Kabra, 8,302 equity shares to Mahendra Kumar Kabra HUF, 16,000 equity shares to Jag-Bid Finvest Private Limited, 16,218 equity shares to Late Umadevi Tribhuvanprasad Kabra, 16,259 equity shares to Mahhesh Tribhuvanprasad Kabra, 16,260 equity shares to Kirtidevi Shreegopal Kabra, 16,261 equity shares to Rajesh Shreegopal Kabra, 87,116 equity shares to Ram Ratna Research and Holdings Private Limited, 103,116 equity shares to Mahendrakumar Rameshwarlal Kabra, 124,611 equity shares to Hemant Mahendrakumar Kabra, and 124,611 equity shares to Sumeet Mahendrakumar Kabra. For details in relation to the scheme of amalgamation, see " <i>History and Certain Corporate Matters – Details regarding material acquisitions or divestments of business or undertakings, mergers, amalgamations or revaluation of assets in the last ten years</i> ", on page 238
March 20, 2023	Pursuant to a resolution passed by our Shareholders on March 20, 2023, our Company sub-divided the face value of its equity shares from ₹10 each to ₹5 each. Accordingly, the issued and paid-up equity share capital of our Company was sub-divided from 23,924,074 equity shares of ₹10 each to 47,848,148 Equity Shares of ₹5 each					
March 20, 2023	Bonus issue in the ratio of 1:1	N.A.	47,848,148	5	-	Issue of Equity Shares as a part of the bonus issuance in the ratio of 1:1 ⁽¹⁾

Date of allotment of equity shares / Shareholders' resolution / buy-back	Nature of allotment/ buy-back	Nature of consideration	Number of equity shares	Face value per equity share (in ₹)	Issue price per equity share (in ₹)	Names of allottees/ shareholders
August 26, 2023	Conversion of Preference Shares to Equity Shares in the ratio of four Equity Shares for every one Preference Shares held	N.A. ⁽²⁾	15,372,560	5	N.A.	Allotment of 11,584,704 Equity Shares to TPG Asia VII SF Pte. Ltd., 505,048 Equity Shares to Dovetail India Fund, 252,524 Equity Shares to Quest Portfolio Services Private Limited, 505,048 Equity Shares to Value Quest S C A L E Fund, 151,512 Equity Shares to Hemang Raichand Dharamshi, 101,008 Equity Shares to Deepak Valji Gala, 505,048 Equity Shares to Jagdish Naresh Master, 505,048 Equity Shares to Ashoka India Equity Investment Trust PLC, 353,532 Equity Shares to Founders Collective Fund, 101,008 Equity Shares to Emerge Capital Opportunities Scheme, and 808,080 Equity Shares to Think India Opportunities Master Fund LP

- (1) Allotment of 47,848,148 Equity Shares of face value ₹5, each as bonus shares credited as fully paid up to 124 shareholders of the Company whose names appear in the register of members/beneficiary's holding position statement provided by NSDL as on the record date i.e., March 17, 2023. The bonus issuance was authorised by the resolutions passed by our Board of Directors and Shareholders at their meeting held on March 16, 2023 and March 20, 2023, respectively and was undertaken by capitalizing an amount of ₹7.51 million in the capital redemption reserves and a surplus of ₹231.73 million available in the retained earnings account as on December 31, 2022. The bonus issuance was not undertaken out of the revaluation reserves or unrealized profit of the Company.
- (2) Cash was paid at the time of allotment of Preference Shares. For further details, see " – Notes to the capital structure – Preference share capital history of our Company" on page 88.

2. Preference share capital history of our Company

Date of allotment of preference shares	Nature of allotment	Nature of consideration	Number of preference shares	Face value per preference share (in ₹)	Issue price per preference share (in ₹)	Name of allottees/ shareholder
September 6, 2018	Preferential issue	Cash	3,702,572	1,080.33	1080.33	Allotment of 3,702,572 Preference Shares to TPG Asia VII SF Pte. Ltd. For further details, see "History and Certain Corporate Matters – Details of shareholders' agreements – Summary of key agreements – Key terms of the shareholders' agreement" on pages 240.
December 23, 2020	Allotment pursuant to the Scheme of Amalgamation 2020	Other than cash	140,568	1,080.33	N.A.	Allotment of 140,568 Preference Shares to TPG Asia VII SF Pte. Ltd. For details in relation to the scheme of amalgamation, see "History and Certain Corporate Matters – Details regarding material acquisitions or divestments of business/undertakings, mergers, amalgamation, any revaluation of assets, etc. in the last 10 years", on page 238.
August 26, 2023	Conversion of Preference Shares to Equity Shares in the ratio of four Equity Shares for every one Preference Shares held	N.A. ⁽¹⁾	(3,843,140)	1,080.33	N.A.	N.A.

- (1) Cash was paid at the time of allotment of Preference Shares.

As of the date of this Red Herring Prospectus, our Company does not have any outstanding preference share capital.

3. **Shares issued for consideration other than cash or by way of bonus issue or out of revaluation reserves**

Our Company has not issued Equity Shares or Preference Shares out of revaluation reserves since its incorporation. Further, except as disclosed below, our Company has not issued Equity Shares or Preference Shares through bonus issue or for consideration other than cash.

Date of allotment*	Number of shares allotted	Face value per share (in ₹)	Issue price per share (in ₹)	Reason for allotment	Benefits accrued to our Company
Equity Shares					
November 28, 2007	4,573,530	10	-	Bonus issue in the ratio of 3:10	-
November 12, 2014	3,700,000	10	-	Allotment pursuant to amalgamation	Amalgamation of Global Electrical Factory (India) Limited and Rsquare Realty Private Limited with our Company
December 23, 2020	528,798	10	-	Allotment pursuant to amalgamation	Amalgamation of Ram Ratna Electricals Limited with our Company
March 20, 2023	47,848,148	5	-	Bonus issue in the ratio of 1:1	-
Preference Shares					
December 23, 2020	140,568	1,080.33	-	Allotment pursuant to amalgamation	Amalgamation of Ram Ratna Electricals Limited with our Company

* For details on name of allottees, see “ – Notes to the capital structure – Equity share capital history of our Company” on page 82.

4. **Issue of shares under Section 391 to 395 of the Companies Act, 1956 and Sections 230 to 234 of the Companies Act**

Other than the allotment of (a) 3,700,000 equity shares pursuant to the Scheme of Amalgamation 2014; and (b) 528,798 equity shares and 140,568 Preference Shares pursuant to the Scheme of Amalgamation 2020, our Company has not allotted any securities in terms of any scheme of arrangement under Sections 230 to 234 of the Companies Act or Sections 391 to 394 of the Companies Act, 1956. For details, see “*History and Certain Corporate Matters – Details regarding material acquisitions or divestments of business or undertakings, mergers, amalgamations or revaluation of assets in the last ten years*” and “ – Notes to the Capital Structure”, on pages 238 and 82, respectively.

5. **Issue of Equity Shares under employee stock option schemes**

Our Company has not issued any Equity Shares under the ESOP Schemes.

6. **Equity Shares issued in the preceding one year below the Offer Price**

Except as disclosed in “ – Notes to the Capital Structure” above, our Company has not issued any equity shares at a price which is lower than the Offer Price during a period of one year preceding the date of this Red Herring Prospectus.

7. **Shareholding Pattern of our Company**

The table below presents the shareholding pattern of our Company as on the date of filing of this Red Herring Prospectus:

Category (I)	Category of shareholder (II)	Number of shareholders (III)	Number of fully paid up Equity Shares held (IV)	Number of partly paid-up Equity Shares held (V)	Number of shares underlying depository receipts (VI)	Total number of shares held (VII) = (IV)+(V) + (VI)	Shareholding as a % of total number of shares (calculated as per SCRR, 1957) (VIII) As a % of (A+B+C2)	Number of voting rights held in each class of securities (IX)			Number of shares underlying convertible securities (including warrants) (X)	Shareholding, as a % assuming full conversion of convertible securities (as a percentage of diluted share capital) (XI) = (VII)+(X) As a % of (A+B+C2)	Number of locked in shares (XII)		Number of shares pledged or otherwise encumbered (XIII)		Number of Equity Shares held in dematerialized form (XIV)	
								Number of voting rights					Total as a % of (A+B + C)	Number (a)	As a % of total shares held (b)	Number (a)		As a % of total shares held (b)
								Class e.g.: Equity Shares	Class e.g.: Others	Total								
(A)	Promoters and Promoter Group	23	73,776,147	-	-	73,776,147	66.42	73,776,147	-	73,776,147	66.42	-	-	-	-	-	73,776,147	
(B)	Public	148	37,292,709	-	-	37,292,709	33.58	37,292,709	-	37,292,709	33.58	-	-	-	-	-	37,292,709	
(C)	Non Promoter-Non Public	-	-	-	-	-	-	-	-	-	-	-	-	-	-	-	-	
(C1)	Shares underlying depository receipts	-	-	-	-	-	-	-	-	-	-	-	-	-	-	-	-	
(C2)	Shares held by employee trusts	-	-	-	-	-	-	-	-	-	-	-	-	-	-	-	-	
	Total	171	111,068,856	-	-	111,068,856	100.00	111,068,856	-	111,068,856	100.00	-	-	-	-	-	111,068,856	

8. Details of equity shareholding of the major Shareholders of our Company

- a) Set forth below is a list of Shareholders holding 1% or more of the paid-up Equity Share capital of our Company, as on the date of this Red Herring Prospectus:

Sr. No.	Name of the Shareholder	Pre-Offer	
		Number of Equity Shares held on a fully diluted basis*	Percentage of the Equity Share capital on a fully diluted basis (%)*
Promoters			
1.	Mahendrakumar Rameshwarlal Kabra	8,648,588	7.78
2.	Tribhuvanprasad Rameshwarlal Kabra	6,896,889	6.20
3.	Kirtidevi Shreegopal Kabra	5,656,308	5.09
4.	Shreegopal Rameshwarlal Kabra	4,629,232	4.16
5.	Kabra Shreegopal Rameshwarlal HUF	3,961,160	3.56
6.	Tribhuvanprasad Kabra HUF	1,436,000	1.29
7.	Mahendra Kumar Kabra HUF	1,154,208	1.04
Promoter Group (other than the Promoters)			
8.	Hemant Mahendrakumar Kabra	6,799,436	6.12
9.	Mahhesh Tribhuvanprasad Kabra	5,872,077	5.28
10.	Sumeet Mahendrakumar Kabra	5,437,324	4.89
11.	Ram Ratna Research and Holdings Private Limited	5,078,464	4.57
12.	Sarita Jhawar	4,784,881	4.30
13.	Rajesh Shreegopal Kabra	4,101,812	3.69
14.	Asha Muchhal	3,308,524	2.98
15.	Priti Amit Saboo	2,684,524	2.41
16.	Jag-Bid Finvest Private Limited	1,344,000	1.21
Public			
17.	TPG Asia VII SF Pte Ltd	18,535,115	16.67
18.	Vvidhi Mahhesh Kabra	4,750,045	4.27
19.	MEW Electricals Limited	2,236,000	2.01
20.	Mamta Ashok Loya	1,908,000	1.72
21.	Ram Ratna Wires Limited	1,364,480	1.23
22.	Monal Rajesh Kabra	1,200,000	1.08
	Total	101,787,067	91.55

* Assuming exercise of 91,864 vested options under ESOP 2020.

- b) Set forth below is a list of Shareholders holding 1% or more of the paid-up Equity Share capital of our Company, as on 10 days prior to the date of this Red Herring Prospectus:

Sr. No.	Name of the Shareholder	Pre-Offer	
		Number of Equity Shares held on a fully diluted basis*	Percentage of the Equity Share capital on a fully diluted basis (%)*
Promoter			
1.	Mahendrakumar Rameshwarlal Kabra	86,48,588	7.78
2.	Tribhuvanprasad Rameshwarlal Kabra	6,896,889	6.20
3.	Shreegopal Rameshwarlal Kabra	4,629,232	4.16
4.	Kirtidevi Shreegopal Kabra	5,656,308	5.09
5.	Tribhuvanprasad Kabra HUF	1,436,000	1.29
6.	Mahendra Kumar Kabra HUF	1,154,208	1.04
7.	Kabra Shreegopal Rameshwarlal HUF	3,961,160	3.56
Promoter Group (other than the Promoters)			
8.	Hemant Mahendrakumar Kabra	6,799,436	6.12
9.	Mahhesh Tribhuvanprasad Kabra	5,872,077	5.28
10.	Sumeet Mahendrakumar Kabra	5,537,324	4.98
11.	Ram Ratna Research and Holdings Private Limited	5,078,464	4.57
12.	Sarita Jhawar	4,779,881	4.30
13.	Rajesh Shreegopal Kabra	4,101,812	3.69
14.	Asha Muchhal	3,308,524	2.98
15.	Priti Amit Saboo	2,684,524	2.41
16.	Jag-Bid Finvest Private Limited	1,344,000	1.21
Public			
17.	TPG Asia VII SF Pte. Ltd.	18,535,115	16.67
18.	Vvidhi Mahhesh Kabra	4,750,045	4.27

Sr. No.	Name of the Shareholder	Pre-Offer	
		Number of Equity Shares held on a fully diluted basis*	Percentage of the Equity Share capital on a fully diluted basis (%)*
19.	MEW Electricals Limited	2,236,000	2.01
20.	Mamta Ashok Loya	1,921,000	1.73
21.	Ram Ratna Wires Limited	1,364,480	1.23
22.	Monal Rajesh Kabra	1,200,000	1.08
	Total	101,895,067	91.65

* Assuming exercise of 91,864 vested options under ESOP 2020.

- c) Set forth below is a list of Shareholders holding 1% or more of the paid-up Equity Share capital of our Company, as on one year prior to the date of this Red Herring Prospectus:

Sr. No.	Name of the Shareholder	Pre-Offer	
		Number of equity shares having face value of ₹10 each held on a fully diluted basis*	Percentage of the equity share capital on a fully diluted basis (%)*
Promoter			
1.	Mahendrakumar Rameshwarlal Kabra	2,162,147	7.79
2.	Tribhuvanprasad Rameshwarlal Kabra	1,220,676	4.40
3.	Shreegopal Rameshwarlal Kabra	748,606	2.70
4.	Kirtidevi Shreegopal Kabra	1,414,077	5.09
5.	Tribhuvanprasad Kabra HUF	359,000	1.29
6.	Mahendra Kumar Kabra HUF	288,552	1.04
7.	Kabra Shreegopal Rameshwarlal HUF	980,290	3.53
Promoter Group (other than the Promoters)			
8.	Rameshwarlal Kabra HUF	2,267,728	8.17
9.	Hemant Mahendrakumar Kabra	1,699,859	6.12
10.	Mahhesh Tribhuvanprasad Kabra	1,396,084	5.03
11.	Sarita Jhawar	1,123,035	4.04
12.	Asha Muchhal	827,131	2.98
13.	Rajesh Shreegopal Kabra	825,453	2.97
14.	Ram Ratna Research and Holdings Private Limited	1,269,616	4.57
15.	Priti Amit Saboo	671,131	2.42
16.	Sumeet Mahendrakumar Kabra	634,657	2.29
17.	Late Ashok S. Loya	340,000	1.22
18.	Jag-Bid Finvest Private Limited	336,000	1.21
Public			
19.	TPG Asia VII SF Pte. Ltd.	5,833,268	21.01
20.	Vvidhi Mahhesh Kabra	1,112,576	4.01
21.	MEW Electricals Limited	559,000	2.01
22.	Ram Ratna Wires Limited	341,120	1.23
	Total	26,410,006	95.12

* Assuming full conversion of 3,843,140 CCPS held by TPG Asia VII SF Pte. Ltd. to 3,843,140 Equity Shares.

- d) Set forth below is a list of Shareholders holding 1% or more of the paid-up Share Capital of our Company, as on two years prior to the date of this Red Herring Prospectus:

Sr. No.	Name of the Shareholder	Pre-Offer	
		Number of equity shares having face value of ₹10 each held on a fully diluted basis*	Percentage of the equity share capital on a fully diluted basis (%)*
Promoters			
1.	Mahendrakumar Rameshwarlal Kabra	2,429,278	8.75
2.	Shreegopal Rameshwarlal Kabra	698,956	2.52
3.	Tribhuvanprasad Rameshwarlal Kabra	565,582	2.04
4.	Kirtidevi Shreegopal Kabra	1,264,426	4.55
5.	Tribhuvanprasad Kabra HUF	359,000	1.29
6.	Mahendra Kumar Kabra HUF	288,552	1.04
7.	Kabra Shreegopal Rameshwarlal HUF	980,290	3.53
Promoter Group (other than the Promoters)			

Sr. No.	Name of the Shareholder	Pre-Offer	
		Number of equity shares having face value of ₹10 each held on a fully diluted basis*	Percentage of the equity share capital on a fully diluted basis (%)*
8.	Late Umadevi Tribhuvanprasad Kabra	3,275,468	11.80
9.	Rameshwarlal Kabra HUF	2,267,728	8.17
10.	Hemant Mahendrakumar Kabra	1,699,859	6.12
11.	Ram Ratna Research and Holdings Private Limited	1,269,616	4.57
12.	Asha Muchhal	827,131	2.98
13.	Priti Amit Saboo	771,131	2.78
14.	Sumeet Mahendrakumar Kabra	634,657	2.29
15.	Mahhesh Tribhuvanprasad Kabra	577,217	2.08
16.	Rameshwarlal Jagannath Kabra	519,930	1.87
17.	Rajesh Shreegopal Kabra	459,437	1.65
18.	Late Ashok S. Loya	340,000	1.22
19.	Jag-Bid Finvest Private Limited	336,000	1.21
Public			
20.	TPG Asia VII SF Pte. Ltd.	5,833,268	21.01
21.	MEW Electricals Limited	559,000	2.01
22.	Ram Ratna Wires Limited	341,120	1.23
	Total	26,297,646	94.71

* Assuming full conversion of 3,843,140 CCPS held by TPG Asia VII SF Pte. Ltd. to 3,843,140 Equity Shares.

9. History of the Equity Share capital held by our Promoters

As on the date of this Red Herring Prospectus, our Promoters, i.e., Tribhuvanprasad Rameshwarlal Kabra, Shreegopal Rameshwarlal Kabra, Mahendrakumar Rameshwarlal Kabra, Kirtidevi Shreegopal Kabra, Tribhuvanprasad Kabra HUF, Kabra Shreegopal Rameshwarlal HUF and Mahendra Kumar Kabra HUF in aggregate hold 32,382,385 Equity Shares, representing 29.14% of the issued, subscribed and paid-up Equity Share capital of our Company on a fully diluted basis. The details regarding our Promoters' shareholding is set forth below.

a) Build-up of Promoters' equity shareholding in our Company

The build-up of the equity shareholding of our Promoters since incorporation of our Company is set forth below.

Date of allotment / transfer	Nature of transaction	Number of equity shares allotted/ transferred	Nature of consideration	Face value per equity share (₹)	Issue price/ transfer price per equity share (₹)	Percentage of the pre-Offer capital (%)^	Percentage of fully diluted post-Offer capital (%)
Tribhuvanprasad Rameshwarlal Kabra							
April 15, 1995	Further issue	60,000	Cash	10	10	0.11	[•]
February 11, 1998	Further issue	3,100	Cash	10	10	0.00	[•]
March 11, 1998	Further issue	30,000	Cash	10	10	0.05	[•]
May 31, 1998	Further issue	55,600	Cash	10	10	0.10	[•]
November 23, 1998	Further issue	60,500	Cash	10	10	0.11	[•]
March 10, 1999	Transfer from Mahendrakumar Rameshwarlal Kabra as a gift	100,000	N.A.	10	N.A.	0.18	[•]
January 15, 2001	Further issue	212,000	Cash	10	10	0.38	[•]

Date of allotment / transfer	Nature of transaction	Number of equity shares allotted/ transferred	Nature of consideration	Face value per equity share (₹)	Issue price/ transfer price per equity share (₹)	Percentage of the pre- Offer capital (%)^	Percentage of fully diluted post-Offer capital (%)
March 8, 2006	Further issue	50,000	Cash	10	20	0.09	[•]
November 28, 2007	Bonus issue in the ratio of 3:10	171,360	N.A.	10	-	0.31	[•]
November 12, 2014	Allotment pursuant to the Scheme of Amalgamation 2014	116,250	Other than cash	10	N.A.	0.21	[•]
September 6, 2018	Transfer to TPG Asia VII SF Pte. Ltd.	(150,000)	Cash	10	1,080.33	(0.27)	[•]
September 11, 2018	Buyback of Equity Shares	(143,272)	Cash	10	1,080.33	(0.26)	[•]
December 23, 2020	Allotment pursuant to the Scheme of Amalgamation 2020	44	Other than cash	10	N.A.	0.00	[•]
April 8, 2022	Transmission from Late Umadevi Tribhuvanprasad Kabra	3,275,468	N.A.	10	N.A.	5.90	[•]
April 22, 2022	Transfer to Sarita Jhawar as a gift	(982,640)	N.A.	10	N.A.	(1.77)	[•]
April 22, 2022	Transfer to Mahhesh Tribhuvanprasad Kabra as a gift	(818,867)	N.A.	10	N.A.	(1.47)	[•]
April 22, 2022	Transfer to Vvidhi Mahhesh Kabra as a gift	(818,867)	N.A.	10	N.A.	(1.47)	[•]
March 20, 2023	Pursuant to a resolution passed by our Shareholders on March 20, 2023, our Company sub-divided the face value of its equity shares from ₹10 each to ₹5 each. Accordingly, the cumulative number of issued, subscribed and paid-up equity shares held by Tribhuvanprasad Rameshwarlal Kabra pursuant to sub-division was 2,441,352 Equity Shares of face value of ₹5 each						
March 20, 2023	Bonus issue in the ratio of 1:1	2,441,352	N.A.	5	-	2.20	[•]
April 19, 2023	Transfer from Rameshwarlal Kabra as a gift	2,014,185	N.A.	5	N.A.	1.81	[•]
Sub-Total (A)		6,896,889				6.21	[•]
Shreegopal Rameshwarlal Kabra							
February 13, 1995	Initial subscription to the Memorandum of Association	100	Cash	10	10	Negligible	[•]
November 23, 1998	Further issue	95,000	Cash	10	10	0.17	[•]

Date of allotment / transfer	Nature of transaction	Number of equity shares allotted/ transferred	Nature of consideration	Face value per equity share (₹)	Issue price/ transfer price per equity share (₹)	Percentage of the pre- Offer capital (%)^	Percentage of fully diluted post-Offer capital (%)
March 29, 2005	Further issue	66,800	Cash	10	15	0.12	[●]
March 8, 2006	Further issue	95,000	Cash	10	20	0.17	[●]
March 30, 2007	Further issue	20,000	Cash	10	50	0.04	[●]
November 28, 2007	Bonus issue in the ratio of 3:10	83,070	N.A.	10	-	0.15	[●]
March 29, 2008	Further issue	123,600	Cash	10	110	0.22	[●]
November 12, 2014	Allotment pursuant to the Scheme of Amalgamation 2014	364,000	Other than cash	10	N.A.	0.66	[●]
September 6, 2018	Transfer to TPG Asia VII SF Pte. Ltd.	(1,600)	Cash	10	1,080.33	Negligible	[●]
September 11, 2018	Buyback of Equity Shares	(47,014)	Cash	10	1,080.33	(0.08)	[●]
December 3, 2019	Transfer to Arjun Kabra	(100,000)	N.A.	10	N.A.	(0.18)	[●]
September 21, 2021	Transfer from Rameshwarlal Jagannath Kabra as a gift	76,820	N.A.	10	N.A.	0.14	[●]
September 21, 2021	Transfer from Ratnidevi Rameshwarlal Kabra as a gift	72,830	N.A.	10	N.A.	0.13	[●]
October 11, 2021	Transfer to Ivaan Kabra as a gift	(100,000)	N.A.	10	N.A.	(0.18)	[●]
December 2, 2022	Transfer from Sanjay Narnarayan Taparia	10,000	Cash	10	1,350	0.02	[●]
March 20, 2023	Pursuant to a resolution passed by our Shareholders on March 20, 2023, our Company sub-divided the face value of its equity shares from ₹10 each to ₹5 each. Accordingly, the cumulative number of issued, subscribed and paid-up equity shares held by Shreegopal Rameshwarlal Kabra pursuant to sub-division was 1,517,212 Equity Shares of face value of ₹5 each						
March 20, 2023	Bonus issue in the ratio of 1:1	1,517,212	N.A.	5	-	1.37	[●]
April 19, 2023	Transfer from Rameshwarlal Kabra as a gift	1,594,808	N.A.	5	N.A.	1.44	[●]
Sub-Total (B)		4,629,232				4.17	[●]
Mahendrakumar Rameshwarlal Kabra							

Date of allotment / transfer	Nature of transaction	Number of equity shares allotted/ transferred	Nature of consideration	Face value per equity share (₹)	Issue price/ transfer price per equity share (₹)	Percentage of the pre-Offer capital (%)^	Percentage of fully diluted post-Offer capital (%)
February 13, 1995	Initial subscription to the Memorandum of Association	100	Cash	10	10	Negligible	[•]
March 18, 1997	Further issue	80,000	Cash	10	10	0.14	[•]
February 11, 1998	Further issue	706,000	Cash	10	10	1.27	[•]
May 31, 1998	Further issue	401,800	Cash	10	10	0.72	[•]
November 23, 1998	Further issue	181,000	Cash	10	10	0.33	[•]
March 10, 1999	Transfer to Mahhesh Tribhuvanprasad Kabra as a gift	(150,000)	Cash	10	N.A.	(0.27)	[•]
March 10, 1999	Transfer to Tribhuvanprasad Rameshwarlal Kabra as a gift	(100,000)	N.A.	10	N.A.	(0.18)	[•]
March 28, 2000	Further issue	285,400	Cash	10	10	0.51	[•]
March 20, 2004	Further issue	130,000	Cash	10	10	0.23	[•]
March 31, 2004	Further issue	398,000	Cash	10	15	0.72	[•]
March 29, 2005	Further issue	66,800	Cash	10	15	0.12	[•]
March 8, 2006	Further issue	181,000	Cash	10	20	0.33	[•]
November 28, 2007	Bonus issue in the ratio of 3:10	654,030	N.A.	10	-	1.18	[•]
November 12, 2014	Allotment pursuant to the Scheme of Amalgamation 2014	200,000	Other than cash	10	N.A.	0.36	[•]
September 6, 2018	Transfer to TPG Asia VII SF Pte. Ltd.	(594,645)	Cash	10	1,080.33	(1.07)	[•]
September 11, 2018	Buyback of Equity Shares	(113,323)	Cash	10	1,080.33	(0.20)	[•]
December 23, 2020	Allotment pursuant to the Scheme of Amalgamation 2020	103,116	Other than cash	10	N.A.	0.19	[•]
September 21, 2021	Transfer to Kirtidevi	(149,651)	N.A.	10	N.A.	(0.27)	[•]

Date of allotment / transfer	Nature of transaction	Number of equity shares allotted/ transferred	Nature of consideration	Face value per equity share (₹)	Issue price/ transfer price per equity share (₹)	Percentage of the pre-Offer capital (%)^	Percentage of fully diluted post-Offer capital (%)
	Shreegopal Kabra as a gift						
September 22, 2021	Transfer to Rajesh Shreegopal Kabra as a gift	(117,480)	N.A.	10	N.A.	(0.21)	[•]
March 20, 2023	Pursuant to a resolution passed by our Shareholders on March 20, 2023, our Company sub-divided the face value of its equity shares from ₹10 each to ₹5 each. Accordingly, the cumulative number of issued, subscribed and paid-up equity shares held by Mahendrakumar Rameshwarlal Kabra pursuant to sub-division was 4,324,294 Equity Shares of face value of ₹5 each						
March 20, 2023	Bonus issue in the ratio of 1:1	4,324,294	N.A.	5	-	3.89	[•]
Sub-Total (C)		8,648,588				7.78	[•]
Kirtidevi Shreegopal Kabra							
February 13, 1995	Initial subscription to the Memorandum of Association	100	Cash	10	10	Negligible	[•]
April 15, 1995	Further issue	170,000	Cash	10	10	0.31	[•]
February 11, 1998	Further issue	654,390	Cash	10	10	1.18	[•]
May 31, 1998	Further issue	224,200	Cash	10	10	0.40	[•]
November 23, 1998	Further issue	150,000	Cash	10	10	0.27	[•]
March 10, 1999	Transfer to Hemant Mahendrakumar Kabra as a gift	(200,000)	N.A.	10	N.A.	(0.36)	[•]
March 10, 1999	Transfer to Mahendra Kumar Kabra HUF as a gift	(100,000)	N.A.	10	N.A.	(0.18)	[•]
March 10, 1999	Transfer to Sumeet Mahendrakumar Kabra as a gift	(150,000)	N.A.	10	N.A.	(0.27)	[•]
January 15, 2001	Further issue	1,610	Cash	10	10	Negligible	[•]
March 29, 2005	Further issue	100,000	Cash	10	15	0.18	[•]
March 8, 2006	Further issue	100,000	Cash	10	20	0.18	[•]
March 30, 2007	Further issue	12,000	Cash	10	50	0.02	[•]
November 28, 2007	Bonus issue in the ratio of 3:10	288,690	N.A.	10	-	0.52	[•]
March 29, 2008	Further issue	12,926	Cash	10	110	0.02	[•]

Date of allotment / transfer	Nature of transaction	Number of equity shares allotted/ transferred	Nature of consideration	Face value per equity share (₹)	Issue price/ transfer price per equity share (₹)	Percentage of the pre- Offer capital (%)^	Percentage of fully diluted post-Offer capital (%)
November 12, 2014	Allotment pursuant to the Scheme of Amalgamation 2014	281,750	Other than cash	10	N.A.	0.51	[•]
September 6, 2018	Transfer to TPG Asia VII SF Pte. Ltd.	(236,500)	Cash	10	1,080.33	(0.43)	[•]
September 11, 2018	Buyback of Equity Shares	(61,000)	Cash	10	1,080.33	(0.11)	[•]
December 23, 2020	Allotment pursuant to the Scheme of Amalgamation 2020	16,260	Other than cash	10	N.A.	0.03	[•]
September 21, 2021	Transfer from Mahendrakumar Rameshwarlal Kabra as a gift	149,651	N.A.	10	N.A.	0.27	[•]
March 20, 2023	Pursuant to a resolution passed by our Shareholders on March 20, 2023, our Company sub-divided the face value of its equity shares from ₹10 each to ₹5 each. Accordingly, the cumulative number of issued, subscribed and paid-up equity shares held by Kirtidevi Shreegopal Kabra pursuant to sub-division was 2,828,154 Equity Shares of face value of ₹5 each						
March 20, 2023	Bonus issue in the ratio of 1:1	2,828,154	N.A.	5	-	2.55	[•]
Sub-Total (D)		5,656,308				5.09	[•]
Tribhuvanprasad Kabra HUF							
February 11, 1998	Further issue	10,000	Cash	10	10	0.02	[•]
January 15, 2001	Further issue	110,000	Cash	10	10	0.20	[•]
March 31, 2004	Further issue	155,000	Cash	10	15	0.28	[•]
November 28, 2007	Bonus issue in the ratio of 3:10	82,500	N.A.	10	-	0.15	[•]
November 12, 2014	Allotment pursuant to the Scheme of Amalgamation	1,500	Other than cash	10	N.A.	Negligible	[•]
March 20, 2023	Pursuant to a resolution passed by our Shareholders on March 20, 2023, our Company sub-divided the face value of its equity shares from ₹10 each to ₹5 each. Accordingly, the cumulative number of issued, subscribed and paid-up equity shares held by Tribhuvanprasad Kabra HUF pursuant to sub-division was 718,000 Equity Shares of face value of ₹5 each						
March 20, 2023	Bonus issue in the ratio of 1:1	718,000	N.A.	5	-	0.65	[•]
Sub-Total (E)		1,436,000				1.29	[•]
Kabra Shreegopal Rameshwarlal HUF							
February 11, 1998	Further issue	227,500	Cash	10	10	0.41	[•]

Date of allotment / transfer	Nature of transaction	Number of equity shares allotted/ transferred	Nature of consideration	Face value per equity share (₹)	Issue price/ transfer price per equity share (₹)	Percentage of the pre- Offer capital (%)^	Percentage of fully diluted post-Offer capital (%)
May 31, 1998	Further issue	180,000	Cash	10	10	0.32	[●]
November 23, 1998	Further issue	60,000	Cash	10	10	0.11	[●]
March 8, 2006	Further issue	23,170	Cash	10	20	0.04	[●]
March 30, 2007	Further issue	29,000	Cash	10	50	0.05	[●]
November 28, 2007	Bonus issue in the ratio of 3:10	155,901	N.A.	10	-	0.28	[●]
March 29, 2008	Further issue	2,719	Cash	10	110	Negligible	[●]
November 12, 2014	Allotment pursuant to the Scheme of Amalgamation 2014	304,500	Other than cash	10	N.A.	0.55	[●]
September 6, 2018	Transfer to TPG Asia VII SF Pte. Ltd.	(2,500)	Cash	10	1,080.33	Negligible	[●]
December 2, 2022	Transfer from Sanjay Narnarayan Taparia	10,000	Cash	10	1,350	0.02	[●]
March 20, 2023	Pursuant to a resolution passed by our Shareholders on March 20, 2023, our Company sub-divided the face value of its equity shares from ₹10 each to ₹5 each. Accordingly, the cumulative number of issued, subscribed and paid-up equity shares held by Kabra Shreegopal Rameshwarlal HUF pursuant to sub-division was 1,980,580 Equity Shares of face value of ₹5 each						
March 20, 2023	Bonus issue in the ratio of 1:1	1,980,580	N.A.	5	-	1.78	[●]
Sub-Total (F)		3,961,160				3.56	[●]
Mahendra Kumar Kabra HUF							
February 11, 1998	Further issue	20,000	Cash	10	10	0.04	[●]
March 11, 1998	Further issue	20,000	Cash	10	10	0.04	[●]
May 31, 1998	Further issue	10,000	Cash	10	10	0.02	[●]
March 10, 1999	Transfer from Kirtidevi Shreegopal Kabra as a gift	100,000	N.A.	10	N.A.	0.18	[●]
March 8, 2006	Further issue	65,000	Cash	10	20	0.12	[●]
November 28, 2007	Bonus issue in the ratio of 3:10	64,500	N.A.	10	-	0.12	[●]

Date of allotment / transfer	Nature of transaction	Number of equity shares allotted/ transferred	Nature of consideration	Face value per equity share (₹)	Issue price/ transfer price per equity share (₹)	Percentage of the pre- Offer capital (%)^	Percentage of fully diluted post-Offer capital (%)
November 12, 2014	Allotment pursuant to the Scheme of Amalgamation 2014	750	Other than cash	10	N.A.	Negligible	[•]
December 23, 2020	Allotment pursuant to the Scheme of Amalgamation 2020	8,302	Other than cash	10	N.A.	0.01	[•]
March 20, 2023	Pursuant to a resolution passed by our Shareholders on March 20, 2023, our Company sub-divided the face value of its equity shares from ₹10 each to ₹5 each. Accordingly, the cumulative number of issued, subscribed and paid-up equity shares held by Mahendra Kumar Kabra HUF pursuant to sub-division was 577,104 Equity Shares of face value of ₹5 each						
March 20, 2023	Bonus issue in the ratio of 1:1	577,104	N.A.	5	-	0.52	[•]
Sub-Total (G)		1,154,208				1.04	[•]
Total (A+B+C+D+E+F+G)		32,382,385				29.14	[•]

^ Assuming exercise of 91,864 vested options under ESOP 2020.

All the Equity Shares held by our Promoters were fully paid-up on the respective dates of allotment of such Equity Shares. As on the date of this Red Herring Prospectus, none of the Equity Shares held by our Promoters are subject to any pledge.

b) *Shareholding of our Promoters and Promoter Group*

The details of shareholding of our Promoters, and the Promoter Group (other than our Promoters) as on the date of this Red Herring Prospectus are set forth below:

S. No.	Name of the shareholder	Pre-Offer number of Equity Shares held on a fully diluted basis	Percentage of the pre-Offer Equity share capital (on a fully diluted basis)(%)*	Post-Offer number of Equity Shares	Percentage of the post-Offer Equity Share capital (%)
Promoters					
1.	Tribhuvanprasad Rameshwarlal Kabra	6,896,889	6.21	[•]	[•]
2.	Shreegopal Rameshwarlal Kabra	4,629,232	4.16	[•]	[•]
3.	Mahendrakumar Rameshwarlal Kabra	8,648,588	7.78	[•]	[•]
4.	Kirtidevi Shreegopal Kabra	5,656,308	5.09	[•]	[•]
5.	Tribhuvanprasad Kabra HUF	1,436,000	1.29	[•]	[•]
6.	Kabra Shreegopal Rameshwarlal HUF	3,961,160	3.56	[•]	[•]
7.	Mahendra Kumar Kabra HUF	1,154,208	1.04	[•]	[•]
Sub-Total (A)		32,382,385	29.13	[•]	[•]
Promoter Group					
1.	Anant Satyanarayan Loya	260,000	0.23	[•]	[•]
2.	Asha Muchhal	3,308,524	2.98	[•]	[•]
3.	Gaurishankar Satyanarayan Loya	440,000	0.40	[•]	[•]
4.	Hemant Mahendrakumar Kabra	6,799,436	6.12	[•]	[•]
5.	Jag-Bid Finvest Private Limited	1,344,000	1.21	[•]	[•]
6.	Kabel Buildcon Solutions Private Limited	707,200	0.64	[•]	[•]
7.	KGR Worldwide Solutions LLP	345,000	0.31	[•]	[•]
8.	Kishori Dinesh Modani	84,520	0.08	[•]	[•]
9.	Mahesh Tribhuvanprasad Kabra	5,872,077	5.28	[•]	[•]
10.	Priti Amit Saboo	2,684,524	2.42	[•]	[•]
11.	Rajesh Shreegopal Kabra	4,101,812	3.69	[•]	[•]
12.	Ram Ratna Infrastructure Private Limited	110,000	0.10	[•]	[•]
13.	Ram Ratna Research and Holdings Private Limited	5,078,464	4.57	[•]	[•]

S. No.	Name of the shareholder	Pre-Offer number of Equity Shares held on a fully diluted basis	Percentage of the pre-Offer Equity share capital (on a fully diluted basis)(%)*	Post-Offer number of Equity Shares	Percentage of the post-Offer Equity Share capital (%)
14.	Saraswatidevi Satyanarayan Loya	36,000	0.03	[●]	[●]
15.	Sarita Jhawar	4,784,881	4.30	[●]	[●]
16.	Sumeet Mahendrakumar Kabra	5,437,324	4.89	[●]	[●]
Sub-Total (B)		41,393,762	37.24	[●]	[●]
Total (A+B)		73,776,147	66.37	[●]	[●]

* Assuming exercise of 91,864 vested options under ESOP 2020.

10. History of the share capital held by TPG Asia VII SF Pte. Ltd

As on the date of this Red Herring Prospectus, TPG Asia VII SF Pte. Ltd in aggregate hold 18,535,115 Equity Shares, representing 16.67% of the issued, subscribed and paid-up Equity Share capital of our Company on a fully diluted basis. The details regarding its shareholding is set forth below.

Date of allotment/ transfer	Nature of transaction	Number of shares allotted/ transferred	Nature of consideration	Face value per share (₹)	Issue price/ transfer price per share / (₹)	Percentage of the pre-Offer capital (%)^	Percentage of fully diluted post-Offer capital (%)
Equity Shares							
September 6, 2018	Transfer from Tribhuvanprasad Rameshwarlal Kabra	150,000	Cash	10	1,080.33	0.27	[●]
	Transfer from Shreegopal Rameshwarlal Kabra	1,600	Cash	10	1,080.33	0.00	[●]
	Transfer from Mahendrakumar Rameshwarlal Kabra	594,645	Cash	10	1,080.33	1.07	[●]
	Transfer from Kirtidevi Shreegopal Kabra	236,500	Cash	10	1,080.33	0.43	[●]
	Transfer from Kabra Shreegopal Rameshwarlal HUF	2,500	Cash	10	1,080.33	0.00	[●]
	Transfer from Rameshwarlal Kabra	450	Cash	10	1,080.33	0.00	[●]
	Transfer from Rameshwarlal Kabra HUF	3,015	Cash	10	1,080.33	0.01	[●]
	Transfer from Ratnidevi Kabra	2,135	Cash	10	1,080.33	0.00	[●]
	Transfer from Late Umadevi Tribhuvanprasad Kabra	150,000	Cash	10	1,080.33	0.27	[●]
	Transfer from Mahhesh Tribhuvanprasad Kabra	233,542	Cash	10	1,080.33	0.42	[●]

Date of allotment/ transfer	Nature of transaction	Number of shares allotted/ transferred	Nature of consideration	Face value per share (₹)	Issue price/ transfer price per share / (₹)	Percentage of the pre- Offer capital (%)^	Percentage of fully diluted post-Offer capital (%)
	Transfer from Rajesh Shreegopal Kabra	247,942	Cash	10	1,080.33	0.45	[●]
	Transfer from Sumeet Mahendrakumar Kabra	116,744	Cash	10	1,080.33	0.21	[●]
	Transfer from Asha Muchhal	45,000	Cash	10	1,080.33	0.08	[●]
	Transfer from Anant S. Loya HUF	30,230	Cash	10	1,080.33	0.05	[●]
	Transfer from Ashish G. Loya	12,225	Cash	10	1,080.33	0.02	[●]
	Transfer from Late Ashok S. Loya	21,630	Cash	10	1,080.33	0.04	[●]
	Transfer from Gaurishankar Satyanarayan Loya HUF	13,000	Cash	10	1,080.33	0.02	[●]
	Transfer from Nikunj Ashok Loya	25,521	Cash	10	1,080.33	0.05	[●]
	Transfer from Mamta Ashok Loya	23,375	Cash	10	1,080.33	0.04	[●]
	Transfer from Gaurishankar Satyanarayan Loya	15,174	Cash	10	1,080.33	0.03	[●]
	Transfer from Late Satyanarayan Loya	38,000	Cash	10	1,080.33	0.07	[●]
	Transfer from Satyanarayan Mohanlal Loya (HUF)	26,900	Cash	10	1,080.33	0.05	[●]
March 20, 2023	Pursuant to a resolution passed by our Shareholders on March 20, 2023, our Company sub-divided the face value of its equity shares from ₹10 each to ₹5 each. Accordingly, the cumulative number of issued, subscribed and paid-up equity shares held by TPG pursuant to sub-division was 3,980,256 Equity Shares of face value of ₹5 each						
March 20, 2023	Bonus issue in the ratio of 1:1	3,980,256	N.A.	5	-	3.58	[●]
August 11, 2023	Transfer to SBI Life Insurance Company Limited	(1,010,101)	Cash	5	990	(0.91)	[●]
August 26, 2023	Conversion of Preference Shares to Equity Shares in the ratio of four Equity Shares for every one	11,584,704	N.A. ⁽¹⁾	5	N.A.	10.42	[●]

Date of allotment/ transfer	Nature of transaction	Number of shares allotted/ transferred	Nature of consideration	Face value per share (₹)	Issue price/ transfer price per share / (₹)	Percentage of the pre- Offer capital (%)^	Percentage of fully diluted post-Offer capital (%)
	Preference Shares held						
Sub-Total		18,535,115				16.67	[●]
Preference Shares							
September 6, 2018	Preferential issue	3,702,572	Cash	1,080.33	1080.33	3.33	[●]
December 23, 2020	Allotment pursuant to the Scheme of Amalgamation 2020	140,568	Other than cash	1,080.33	N.A.	0.13	[●]
August 11, 2023	Transfer to Dovetail India Fund – Class 6 Shares	(126,262)	Cash	1,080.33	3,960	(0.11)	[●]
	Transfer to Quest Portfolio Services Private Limited	(63,131)	Cash	1,080.33	3,960	(0.06)	[●]
	Transfer to Value Quest S C A L E Fund	(126,262)	Cash	1,080.33	3,960	(0.11)	[●]
	Transfer to Hemang Raichand Dharamshi	(37,878)	Cash	1,080.33	3,960	(0.03)	[●]
	Transfer to Deepak Valji Gala	(25,252)	Cash	1,080.33	3,960	(0.02)	[●]
	Transfer to Jagdish Naresh Master	(126,262)	Cash	1,080.33	3,960	(0.11)	[●]
	Transfer to Founders Collective Fund	(88,383)	Cash	1,080.33	3,960	(0.08)	[●]
	Transfer to Emerge Capital Opportunities Scheme	(25,252)	Cash	1,080.33	3,960	(0.02)	[●]
August 14, 2023	Transfer to Think India Opportunities Master Fund LP.	(202,020)	Cash	1,080.33	3,960	(0.18)	[●]
	Transfer to Ashoka India Equity Investment Trust PLC	(126,262)	Cash	1,080.33	3,960	(0.11)	[●]
August 26, 2023	Pursuant to resolution passed by our Board at their meeting held on August 26, 2023, Preference Shares were converted to Equity Shares in the ratio of four Equity Shares for every one Preference Shares held.						

(1) Cash was paid at the time of allotment of Preference Shares.

^ Assuming exercise of 91,864 vested options under ESOP 2020.

11. Details of Promoters' Contribution and Lock-in

- a) In accordance with Regulation 14 and Regulation 16(1) of the SEBI ICDR Regulations, an aggregate of 20% of the fully diluted post-Offer Equity Share capital of our Company held by our Promoters (assuming exercise

of vested options, if any, under the ESOP Schemes), shall be locked in for a period of 18 months, or such other period as prescribed under the SEBI ICDR Regulations, as minimum promoters' contribution from the date of Allotment ("**Promoters' Contribution**"), and our Promoters' shareholding in excess of 20% of the post-Offer equity share capital shall be locked in for a period of six months from the date of Allotment.

- b) The details of the Equity Shares to be locked-in for a period of 18 months, or such other period as prescribed under the SEBI ICDR Regulations from the date of Allotment as Promoters' Contribution are set forth in the table below:

Name of Promoter	Number of equity shares locked-in(1)(2)	Date of allotment/transfer	Nature of transaction	Face value per equity share (₹)	Issue/acquisition price per equity share (₹)	Percentage of pre-Offer paid-up Equity Share capital	Percentage of post-Offer paid-up Equity Share capital*	Date up to which the equity shares are subject to lock in
[●]	[●]	[●]	[●]	[●]	[●]	[●]	[●]	[●]
[●]	[●]	[●]	[●]	[●]	[●]	[●]	[●]	[●]
Total	[●]	[●]	[●]	[●]	[●]	[●]	[●]	[●]

* Subject to finalisation of the Basis of Allotment.

(1) For a period of 18 months or such other period as prescribed under SEBI ICDR Regulations from the date of Allotment.

(2) All Equity Shares were fully paid-up at the time of Allotment.

Our Promoters have given their consent to include such number of Equity Shares held by them as disclosed above, constituting 20% of the fully diluted post-Offer Equity Share capital of our Company as Promoters' Contribution. Our Promoters have agreed not to sell, transfer, charge, pledge or otherwise encumber in any manner the Promoters' Contribution from the date of filing the Draft Red Herring Prospectus, until the expiry of the lock-in period specified above, or for such other time as required under SEBI ICDR Regulations, except as may be permitted, in accordance with the SEBI ICDR Regulations.

- c) Our Company undertakes that the Equity Shares that are being locked-in are not and will not be ineligible for computation of Promoters' Contribution in terms of Regulation 15 of the SEBI ICDR Regulations. For details of the build-up of the share capital held by our Promoters, see "*History of the Equity Share capital held by our Promoters*" on page 93.

In this connection, we confirm that the Equity Shares considered as Promoters' Contribution:

- (i) have not been acquired during the immediately preceding three years from the date of this Red Herring Prospectus for consideration other than cash, involving any revaluation of assets or capitalisation of intangible assets;
- (ii) did not result from a bonus issue of Equity Shares during the immediately preceding three years from the date of this Red Herring Prospectus, by utilisation of revaluation reserves or unrealised profits of the Company, or from bonus issue against Equity Shares which are otherwise ineligible for Promoters' Contribution;
- (iii) are not acquired or subscribed to during the immediately preceding year from the date of this Red Herring Prospectus at a price lower than the price at which the Equity Shares are being offered to the public in the Offer; and
- (iv) are not subject to any pledge or any other encumbrance.

All Equity Shares held by our Promoters are held in dematerialized form.

Further, our Company has not been formed by conversion of a partnership firm or a limited liability partnership firm into a company and hence, no Equity Shares have been issued in the one year immediately preceding the date of this Red Herring Prospectus pursuant to conversion from a partnership firm.

12. Details of Equity Shares locked-in for six months:

In addition to 20% of the fully diluted post-Offer shareholding of our Company held by our Promoters and locked-in for a period of 18 months as specified above, in terms of the SEBI ICDR Regulations, the entire pre-Offer Equity Share capital of our Company will be locked-in for a period of six months from the date of Allotment, including any

unsubscribed portion of the Offer for Sale, and any other categories of shareholders exempted under Regulation 17 of the SEBI ICDR Regulations, as applicable.

As required under Regulation 20 of the SEBI ICDR Regulations, our Company shall ensure that the details of the Equity Shares locked-in are recorded by the relevant Depository.

In terms of Regulation 22 of the SEBI ICDR Regulations, the Equity Shares held by the Promoters, which are locked-in may be transferred to another promoter or another members of the Promoter Group or to any new promoter or persons in control of our Company, subject to continuation of the lock-in; in the hands of the transferees for the remaining period and in compliance with the SEBI Takeover Regulations, as applicable. Such transferees are not eligible to transfer such transferred Equity Shares till the expiry of the lock-in period.

Pursuant to Regulation 21(a) of the SEBI ICDR Regulations, the Equity Shares held by our Promoters, which are locked-in for a period of 18 months from the date of Allotment may be pledged as collateral security for loans granted by scheduled commercial banks, public financial institutions, NBFC-SI or housing finance companies, provided that such loans have been granted by such bank or institution for the purpose of financing one or more of the objects of the Offer and pledge of the Equity Shares is a term of sanction of such loans, which is not applicable in the context of this Offer.

Pursuant to Regulation 21(b) of the SEBI ICDR Regulations, the Equity Shares held by our Promoters which are locked-in for a period of 6 months from the date of Allotment may be pledged as collateral security for loans granted by scheduled commercial banks, public financial institutions, NBFC-SI or housing finance companies, provided that pledge of the Equity Shares is one of the terms of sanction of such loans.

However, the relevant lock-in period shall continue post the invocation of the pledge referenced above, and the relevant transferee shall not be eligible to transfer the Equity Shares till the relevant lock-in period has expired in terms of the SEBI ICDR Regulations.

In terms of Regulation 22 of the SEBI ICDR Regulations, the Equity Shares held by persons other than the Promoters prior to the Offer and locked-in for a period of six months from the date of Allotment in the Offer may be transferred to any other person holding the Equity Shares which are locked-in along with the Equity Shares proposed to be transferred, subject to continuation of the lock-in in the hands of transferee for the remaining period and compliance with the SEBI Takeover Regulations. Such transferee shall not be eligible to transfer until the expiry of the lock -in period and compliance with the Takeover Regulations.

13. Lock-in of the Equity Shares to be Allotted, if any, to the Anchor Investors

Fifty percent of the Equity Shares allotted to Anchor Investors under the Anchor Investor Portion shall be locked-in for a period of 90 days from the date of Allotment and the remaining Equity Shares allotted to Anchor Investors under the Anchor Investor Portion shall be locked-in for a period of 30 days from the date of Allotment.

14. Our Company presently does not intend or propose to alter its capital structure for a period of six months from the Bid/Offer Opening Date, by way of split or consolidation of the denomination of Equity Shares or further issue of Equity Shares (including issue of securities convertible into or exchangeable, directly or indirectly for Equity Shares) whether on a preferential basis or by way of issue of bonus shares or on a rights basis or by way of further public issue of Equity Shares or otherwise.
15. Except for the issuance of Equity Shares upon conversion of the outstanding Preference Shares and pursuant to exercise of options vested under the ESOP Schemes, there will be no further issue of Equity Shares whether by way of issue of bonus shares, preferential allotment, rights issue or in any other manner during the period commencing from filing of the Draft Red Herring Prospectus with SEBI until the Equity Shares are listed on the Stock Exchanges.
16. As on the date of filing of this Red Herring Prospectus, the total number of Shareholders of our Company is 171.
17. Except as disclosed below and under the section entitled “- *Build-up of Promoters’ equity shareholding in our Company*” on page 93, our Promoters, any member of our Promoter Group, any of the Directors of our Company and their relatives, have not purchased or sold any securities of our Company during the period of six months immediately preceding the date of this Red Herring Prospectus.
- a. Transfer of 9,070,912 Equity Shares from Rameshwarlal Kabra HUF to Rameshwarlal Kabra on April 18, 2023 pursuant to dissolution of Rameshwarlal Kabra HUF;
 - b. Transfer of 2,998,696 Equity Shares, 800,000 Equity Shares, 287,741 Equity Shares, 287,741 Equity Shares, and 287,741 Equity Shares from Rameshwarlal Kabra to Sumeet Mahendrakumar Kabra, Mahhesh Tribhuvanprasad Kabra, Vvidhi Mahhesh Kabra, Sarita Jhavar, respectively, on April 19, 2023 by way of gift; and

- c. Transfer of 800,000 Equity Shares from Rameshwarlal Kabra to Monal Rajesh Kabra, on April 20, 2023 by way of gift.
 - d. Transfer of 120,000 Equity Shares from Anant Satyanarayan Loya to KGR Worldwide Solutions LLP, 120,000 Equity Shares from Satyanarayan Mohanlal Loya HUF to KGR Worldwide Solutions LLP, 105,000 Equity Shares from Gaurishankar Satyanarayan Loya to KGR Worldwide Solutions LLP, 100,000 Equity Shares from Sumeet Mahendrakumar Kabra to Ram Ratna Infrastructure Private Limited, 10,000 Equity Shares from Gaurishankar Satyanarayan Loya to Ram Ratna Infrastructure Private Limited, and 5,000 Equity Shares from Gaurishankar Satyanarayan Loya to Sarita Jhawar, on August 28, 2023.
18. There have been no financing arrangements whereby members of our Promoter Group, our Directors and their relatives, have financed the purchase by any other person of securities of our Company during a period of six months immediately preceding the date of filing of the Draft Red Herring Prospectus and this Red Herring Prospectus.
 19. Neither our Company, nor any of our Directors have entered into any buy-back arrangements for purchase of Equity Shares from any person. Further, the BRLMs have not made any buy-back arrangements for purchase of Equity Shares from any person.
 20. There are no partly paid-up Equity Shares as on the date of this Red Herring Prospectus, and all the Equity Shares transferred pursuant to the Offer will be fully paid-up at the time of Allotment.
 21. Our Promoters and the members of our Promoter Group shall not participate in the Offer except to the extent of their participation in the Offer for Sale.
 22. No person connected with the Offer, including, but not limited to, the BRLMs, the members of the Syndicate, our Company, the Directors, members of our Promoter Group, the Promoters or Group Company, shall offer or make payment of any incentive, direct or indirect, in the nature of discount, commission and allowance, except for fees or commission for services rendered in relation to the Offer, in any manner, whether in cash or kind or services or otherwise, to any Bidder for making a Bid.
 23. As on the date of this Red Herring Prospectus, the BRLMs and their respective associates (as defined in the Securities and Exchange Board of India (Merchant Bankers) Regulations, 1992 do not hold any Equity Shares or Preference Shares of our Company. The BRLMs and their affiliates may engage in the transactions with and perform services for our Company in the ordinary course of business or may in the future engage in commercial banking and investment banking transactions with our Company for which they may in the future receive customary compensation.
 24. Except for the Preference Shares, there are no outstanding warrants, options or rights to convert debentures, loans or other instruments into, or which would entitle any person any option to receive Equity Shares as on the date of this Red Herring Prospectus.
 25. Our Company shall ensure that all transactions in the securities of the Company by our Promoters and the Promoter Group between the date of filing of this Red Herring Prospectus and the date of closure of the Offer shall be intimated to the Stock Exchanges within 24 hours of such transactions.
 26. There shall be only one denomination of the Equity Shares, unless otherwise permitted by law.
 27. **Employee Stock Option Schemes of our Company**

ESOP 2020

Our Company, pursuant to the resolution passed by our Board on September 28, 2020 and the resolution passed by the Shareholders on November 10, 2020, adopted ESOP 2020. The ESOP 2020 is in compliance with the SEBI SBEB & SE Regulations and was last amended by our Shareholders in their meeting dated April 11, 2023.

Upon exercise of vested options by a participating employee (“**Employee**”) and issuance of Equity Shares by our Company to an Employee under ESOP 2020, our Company, the Employee and the Investor Selling Shareholder are required to enter into a management shareholders’ agreement (“**Agreement**”). The Agreement provides that in the event that the Investor Selling Shareholder proposes to offer all or any of the Equity Shares held by it in an offer for sale of our Company’s Equity Shares during a proposed listing, the Employee shall be entitled to sell pro rata Equity Shares received pursuant to exercise of vested options in the offer for sale. The Agreement also includes, *inter alia*, (i) restrictions on the transfer of Equity Shares by the Employee, (ii) call rights exercisable by our Company, Shareholders or any other buyer as determined by our Company to purchase Equity Shares from the Employee, (iii) drag-along rights exercisable by the Investor Selling Shareholder to require the Employee to transfer their Equity Shares to a purchaser, and (iv) tag-along rights exercisable by the Employee to transfer their Equity Shares along with the Investor Selling Shareholder to a purchaser.

However, pursuant to the resolution passed by our Shareholders in their meeting dated April 11, 2023, ESOP 2020 was amended to inter alia align its provisions with the requirements of the SEBI SBEB Regulations and terminate the right previously available to our Company and Shareholders to purchase equity shares from the eligible employees. Further, the provisions of the Agreement and related provisions under ESOP 2020 shall automatically cease to have effect or be applicable from the commencement of listing of Equity Shares on the Stock Exchanges pursuant to the Offer.

As on the date of this Red Herring Prospectus, none of the employees of our Company have entered into an Agreement with our Company and the Investor Selling Shareholder.

The summary of ESOP 2020 (mentioned on post sub-division of equity shares and issuance of bonus Equity Shares on March 20, 2023 basis) as on the date of this Red Herring Prospectus, are as provided below:

Particulars	Total [#]
Options granted	340,840
Options vested (net)	91,864
Options exercised	Nil
Options forfeited/lapsed/cancelled	1,088,800
Total number of options in force	311,200

[#] As certified by the Independent Chartered Accountant, by way of their certificate dated September 6, 2023.

Pursuant to a resolution passed by the Board on March 20, 2023, the balance options under ESOP 2020 pending to be granted by the Nomination and Remuneration Committee were cancelled and accordingly, there are no options pending grant under ESOP 2020.

The details of ESOP 2020 post sub-division and bonus issuance is as provided below:

Particulars	Details [#]				
	From July 1, 2023 till the date of this Red Herring Prospectus	For the three month period ended June 30, 2023	Fiscal 2023	Fiscal 2022	Fiscal 2021
Total options outstanding as at the beginning of the period	311,200	340,840	481,520	259,184	-
Total options granted	-	-	44,480	4,81,520	518,360
Exercise price of options in ₹ (as on the date of grant options)	-	-	450.00	318,480 options were granted at the exercise price of ₹ 270.08 per equity shares 163,040 options were granted at the exercise price of ₹ 337.50 per equity shares	270.08
Options forfeited/lapsed/cancelled	-	29,640	185,160	259,184	259,176
Variation of terms of options	There has been no variation in terms of options as on the date of this Red Herring Prospectus				
Money realized by exercise of options during the year/period	There has been no exercise of options as on the date of this Red Herring Prospectus				
Total number of options outstanding in force at the end of period/year	311,200	311,200	340,840	481,520	259,184
Total options vested (excluding the options that have been exercised)	26,672	10,368	54,824	Nil	Nil
Options exercised	There has been no exercise of options as on the date of this Red Herring Prospectus				
The total number of Equity Shares arising as a result of full	There has been no exercise of options as on the date of this Red Herring Prospectus				

Particulars	Details [#]				
	From July 1, 2023 till the date of this Red Herring Prospectus	For the three month period ended June 30, 2023	Fiscal 2023	Fiscal 2022	Fiscal 2021
exercise of granted options (including options that have been exercised)					
Employee wise details of options granted to:					
(i) Key managerial personnel:					
Partha Chakraborti	-	-	-	-	185,128
Rajeev Pandiya	-	-	-	185,160	-
(ii) Senior management personnel:					
Vivek Abrol	-	-	-	133,320	-
Sanjay Narnarayan Taparia	-	-	-	59,280	-
Rajesh Babu Jain	-	-	-	59,280	-
Vinod Parur	-	-	-	14,840	-
Hemal Savla	-	-	-	29,640	-
Satishkumar Anandilal Agarwal	-	-	44,480	-	-
(iii) Any other employee who receives a grant in any one year of options amounting to 5% or more of the options granted during the year					
Joydeep Mukherjee	-	-	-	-	259,184
Amit Sethi	-	-	-	-	74,048
(iii) Identified employees who were granted options during any one year equal to or exceeding 1% of the issued capital (excluding outstanding warrants and conversions) of our Company at the time of grant	No employee have been granted options during any one year equal to or exceeding 1% of the issued capital of the Company				
Lock-in period	Not Applicable as there has been no exercise of options as on the date of this Red Herring Prospectus				
Fully diluted EPS on a pre-Offer basis pursuant to the issue of Equity Shares on exercise of options calculated in accordance with the applicable accounting standard on 'EPS' (in ₹)	Fully diluted EPS as per the Restated Consolidated Financial Information:				
	Particulars	Period ended June 30, 2023	Fiscal Year ended March 31, 2023	Fiscal Year ended March 31, 2022	Fiscal Year ended March 31, 2021
	Diluted EPS	6.68	17.07	19.22	12.18
Description of the pricing formula and method and significant assumptions used to estimate the fair value of options granted during the year including, weighted average information, namely, risk-free	Options have been valued based on fair value method as prescribed under Ind AS 102, Share based payments, using Black Scholes valuation option pricing model by using the fair value of the Company's shares on the grant date and assumptions. Refer Note (2)				

Particulars	Details [#]				
	From July 1, 2023 till the date of this Red Herring Prospectus	For the three month period ended June 30, 2023	Fiscal 2023	Fiscal 2022	Fiscal 2021
interest rate, expected life, expected volatility, expected dividends and the price of the underlying share in market at the time of grant of the option					
Impact on the profits and on the Earnings per Equity Share of the last three years if the accounting policies specified in the SEBI SBEB & SE Regulations had been followed, in respect of options granted in the last three years	Not applicable, as the Company is calculating employee compensation cost using fair value at grant date.				
Where our Company has calculated the employee compensation cost using the intrinsic value of the stock options, the difference, if any, between employee compensation cost so computed and the employee compensation calculated on the basis of fair value of the stock options and the impact of this difference, on the profits of the Company and on the Earnings per Equity Share of our Company	Not applicable, as the Company is calculating employee compensation cost using fair value at grant date.				
Intention of the Key Managerial Personnel, Senior Management Personnel and whole-time directors who are holders of Equity Shares allotted on exercise of options granted to sell their Equity Shares within three months after the date of listing of Equity Shares pursuant to the Offer	As per the confirmation received, the Key Managerial Personnel and Senior Management Personnel will not sell their Equity Shares, if exercised, within three months from the date of listing of the Equity Shares.				
Intention to sell Equity Shares arising out of ESOP 2020 within three months after the listing of Equity Shares, by Directors, Key Managerial Personnel, Senior Management Personnel and employees having	Not applicable				

Particulars	Details [#]				
	From July 1, 2023 till the date of this Red Herring Prospectus	For the three month period ended June 30, 2023	Fiscal 2023	Fiscal 2022	Fiscal 2021
Equity Shares arising out of an employee stock option scheme, amounting to more than 1% of the issued capital (excluding outstanding warrants and conversions) of our Company.					

As certified by the Independent Chartered Accountant, by way of their certificate dated September 6, 2023.

Notes:

- (1) ESOP scheme 2020 was implemented in Fiscal 2021 pursuant to approval of the Shareholders in the Extra Ordinary General Meeting held on November 10, 2020.
- (2) A description of the method and significant assumptions used during the following years to estimate the fair values of options, including weighted average information, namely: The Company has used Black Scholes option pricing model. The following tables list the inputs to the models used:

Particulars	From July 1, 2023 till the date of this Red Herring Prospectus	For the three month period ended June 30, 2023	Fiscal 2023	Fiscal 2022	Fiscal 2021
Weighted average exercise price	-	-	N.A.	N.A.	N.A.
Expected volatility (%)			39.10%	38.90%	41.50%
Dividend yield (%)			1%	0%	0%
Expected life (years)			5-7 years	5-7 years	5-7 years
Risk free interest rate (%) (average based on dates of grant)			7.1 % - 7.2% (average 7.15%)	6.2 % - 6.69% (average 6.41%)	5.8% - 6.4% (average 6.15%)

- (3) Pursuant to a resolution passed by the shareholders of the Company on March 20, 2023, the Company has sub-divided the face value of its equity shares from ₹ 10/- each to ₹ 5/- each and issued Bonus Shares in the ratio of 1 (One) : 1(One). Accordingly, the employees' entitlement under Stock Option under ESOP Scheme 2020 stand modified as approved in the meeting of the Board of Directors and Nomination and Remuneration Committee, both held on March 20,2023

ESOP 2023

Our Company, pursuant to the resolution passed by our Board on March 16, 2023 and the resolution passed by the Shareholders on March 20, 2023, adopted the ESOP 2023. The ESOP 2023 is in compliance with the SEBI SBEB & SE Regulations.

As on the date of this Red Herring Prospectus, the summary of ESOP 2023 is as provided below:

Particulars	Total [#]
Options granted	111,120
Options vested	Nil
Options exercised	Nil
Options forfeited/lapsed/cancelled	Nil
Total number of options in force	111,120

As certified by the Independent Chartered Accountant, by way of their certificate dated September 6, 2023.

Particulars	Details [#]		
	From July 1, 2023 till the date of this Red Herring Prospectus	For the three month period ended June 30, 2023	Fiscal 2023
Total options outstanding as at the beginning of the period	111,120	111,120	-
Total options granted	-	-	111,120
Exercise price of options in ₹ (as on the date of grant options)	-	-	450
Options forfeited/lapsed/cancelled	-	-	-
Variation of terms of options	There has been no variation in terms of options as on the date of this Red Herring Prospectus		
Money realized by exercise of options during the year/period	There has been no exercise of options as on the date of this Red Herring Prospectus		
Total number of options outstanding in force at the end of period/year	111,120	111,120	111,120

Particulars	Details [#]		
	From July 1, 2023 till the date of this Red Herring Prospectus	For the three month period ended June 30, 2023	Fiscal 2023
Total options vested (excluding the options that have been exercised)	-	-	-
Options exercised (since implementation of ESOP 2023)	There has been no exercise of options as on the date of this Red Herring Prospectus		
The total number of Equity Shares arising as a result of full exercise of granted options (including options that have been exercised)	There has been no exercise of options as on the date of this Red Herring Prospectus		
Employee wise details of options granted to:			
(i) Key managerial personnel:			
Dinesh Aggarwal	-	-	111,120
(ii) Senior management personnel:			
(iii) Any other employee who receives a grant in any one year of options amounting to 5% or more of the options granted during the year	No employee has received grant in any one year of options amounting to 5% or more of the options granted during the year		
(iv) Identified employees who were granted options during any one year equal to or exceeding 1% of the issued capital (excluding outstanding warrants and conversions) of our Company at the time of grant	No employee has been granted options during any one year equal to or exceeding 1% of the issued capital of the Company		
Lock-in period	Not Applicable as there has been no exercise of options as on the date of RHP		
Fully diluted EPS on a pre-Offer basis pursuant to the issue of Equity Shares on exercise of options calculated in accordance with the applicable accounting standard on 'EPS' (in ₹)	-	6.68	17.07
Description of the pricing formula and method and significant assumptions used to estimate the fair value of options granted during the year including, weighted average information, namely, risk-free interest rate, expected life, expected volatility, expected dividends and the price of the underlying share in market at the time of grant of the option	Options have been valued based on fair value method as prescribed under Ind AS 102, Share based payments, using Black Scholes valuation option pricing model by using the fair value of the Company's shares on the grant date and assumptions		
Impact on the profits and on the Earnings per Equity Share of the last three years if the accounting policies specified in the SEBI SBEB & SE Regulations had been followed, in respect of options granted in the last three years	Not Applicable as no options have been granted		Not applicable as our Company is calculating employee compensation cost using fair value at grant date
Where our Company has calculated the employee compensation cost using the intrinsic value of the stock options, the difference, if any, between employee compensation cost so computed and the employee compensation calculated on the basis of fair value of the stock options and the impact of this difference, on the profits of the Company and on the Earnings per Equity Share of our Company	Not Applicable		Not applicable as our Company is calculating employee compensation cost using fair value at grant date
Intention of the Key Managerial Personnel, Senior Management Personnel and whole-time directors who are holders of Equity Shares allotted on exercise of options granted to sell their Equity Shares within three months after the date of listing of Equity Shares pursuant to the Offer	Not applicable		

Particulars	Details#		
	From July 1, 2023 till the date of this Red Herring Prospectus	For the three month period ended June 30, 2023	Fiscal 2023
Intention to sell Equity Shares arising out of ESOP 2023 within three months after the listing of Equity Shares, by Directors, Key Managerial Personnel, Senior Management Personnel and employees having Equity Shares arising out of an employee stock option scheme, amounting to more than 1% of the issued capital (excluding outstanding warrants and conversions) of our Company.	Not applicable		

As certified by the Independent Chartered Accountant, by way of their certificate dated September 6, 2023.

Notes:

- (1) ESOP scheme 2023 was implemented pursuant to approval of the Shareholders in the Extra Ordinary General Meeting held on March 20, 2023.
- (2) A description of the method and significant assumptions used during the following years to estimate the fair values of options, including weighted average information, namely: The Company has used Black Scholes option pricing model. The following tables list the inputs to the models used based on the Valuation Reports of the approved Registered Valuer:

Particulars	From July 1, 2023 till the date of this Red Herring Prospectus	For the three month period ended June 30, 2023	Fiscal 2023
Weighted average exercise price	-	-	N.A.
Expected volatility (%)			39.10%
Dividend yield (%)			1.00%
Expected life (years)			5-7 years
Risk free interest rate (%) (average based on dates of grant)			7.1 % - 7.2% (average 7.15%)

OBJECTS OF THE OFFER

The Offer comprises of the Fresh Issue and the Offer for Sale.

Offer for Sale

Each of the Selling Shareholders will be entitled to their respective portion of the proceeds from the Offer for Sale in proportion of the Equity Shares offered by the respective Selling Shareholders as part of the Offer for Sale after deducting their proportion of Offer related expenses and relevant taxes thereon. The proceeds of the Offer for Sale shall be received by the Selling Shareholders and will not form part of the Net Proceeds. Our Company will not receive any proceeds from the Offer for Sale. For further details of the Offer for Sale, see “*The Offer*” beginning on page 66.

The Fresh Issue

Requirement of funds

Our Company proposes to utilise the Net Proceeds towards funding of the following objects:

1. Repayment or prepayment, in full or in part, of borrowings availed by our Company from banks and financial institutions; and
2. General corporate purposes.

(collectively, referred to herein as the “**Objects**”).

The main objects and objects incidental and ancillary to the main objects set out in the Memorandum of Association enable us (i) to undertake our existing business activities; and (ii) to undertake the activities proposed to be funded from the Net Proceeds (including the activities for which the funds earmarked towards general corporate purposes shall be used). Further, our Company expects to receive the benefits of listing of the Equity Shares on the Stock Exchanges, including the creation of a public market for our Equity Shares in India.

Net Proceeds

The details of the proceeds from the Fresh Issue are summarised in the following table:

Particulars	Estimated amount
Gross Proceeds from the Fresh Issue	1,800.00
(Less) Offer related expenses in relation to the Fresh Issue ⁽¹⁾	[•]
Net Proceeds⁽¹⁾	[•]

(1) To be finalised upon determination of the Offer Price and updated in the Prospectus prior to filing with the RoC. For details on Offer Expenses, see “Offer Expenses” on page 116.

Utilisation and proposed deployment of Net Proceeds

The Net Proceeds are proposed to be utilised and deployed in accordance with the details provided below:

Particulars	Amount to be funded from the Net Proceeds	Estimated deployment of the Net Proceeds in Fiscal 2024
Repayment or prepayment, in full or in part, of borrowings availed by our Company from banks and financial institutions	1,360.00	1,360.00
General corporate purposes ⁽¹⁾	[•]	[•]
Total	[•]	[•]

(1) To be finalised upon determination of the Offer Price and updated in the Prospectus prior to filing with the RoC. The amount to be utilised for general corporate purposes alone shall not exceed 25% of the Gross Proceeds from the Fresh Issue.

The fund requirements, the deployment of funds and the intended use of the Net Proceeds as described herein are based on our current business plan and circumstances, management estimates, prevailing market conditions and other external commercial and technical factors including interest rates, exchange rate fluctuations and other charges, which are subject to change from time to time. However, such fund requirements and deployment of funds have not been verified or appraised by any bank, financial institution, or any other external agency or party. We may have to revise our funding requirements and deployment schedule on account of a variety of factors such as our financial and market condition, business and strategy, competition, contractual terms and conditions and negotiation with lenders, variation in cost estimates and other external factors such as changes in the business environment and interest or exchange rate fluctuations, which may not be within the control of our management. This may entail rescheduling or revising the planned expenditure and funding requirements, including the expenditure for a particular purpose at the discretion of our management, subject to compliance with applicable laws. For details in relation to the discretion available to our management in respect of use of the Net Proceeds, see “*Risk Factors- Internal Risk*”

Factors – We will not receive any proceeds from the Offer for Sale portion and objects of the Fresh Issue for which the funds are being raised have not been appraised by any bank or financial institutions. Any variation in the utilization of our Net Proceeds as disclosed in this Red Herring Prospectus would be subject to certain compliance requirements, including prior Shareholders’ approval.” on page 32.

Our Company proposes to deploy the entire Net Proceeds towards the aforementioned Objects during Fiscal 2024. In the event that the estimated utilisation of the Net Proceeds in a scheduled fiscal year is not completely met, due to the reasons stated above, the same shall be utilised in the next fiscal year, as may be determined by the Board, in accordance with applicable laws. If the actual utilisation towards any of the Objects is lower than the proposed deployment, such balance will be used towards general corporate purposes, to the extent that the total amount to be utilised towards general corporate purposes is within the permissible limits in accordance with the SEBI ICDR Regulations. Further, in case of variations in the actual utilisation of funds earmarked for the purposes set forth above, increased fund requirements for a particular purpose may be financed by surplus funds, if any, available in respect of the other purposes for which funds are being raised in the Offer, subject to compliance with applicable laws.

Means of finance

The fund requirements set out for the objects of the Offer are proposed to be met entirely from the Net Proceeds. Accordingly, our Company confirms that there is no requirement to make firm arrangements of finance through verifiable means towards at least 75% of the stated means of finance, excluding the amount to be raised from the Fresh Issue and existing identifiable accruals.

Details of the Objects of the Offer

I. Repayment or prepayment, in full or in part, of borrowings availed by our Company from banks and financial institutions

Our Company has entered into various financial arrangements with banks and financial institutions. The credit facilities availed by our Company include borrowings in the form of, *inter alia*, term loans and working capital facilities. For further details, including indicative terms and conditions, see “*Restated Consolidated Financial Information - Annexure VI - Notes to Restated Consolidated Financial Information - Notes 13A and 13B: Borrowings*” and “*Financial Indebtedness*” beginning on pages 311 and 377, respectively. As on August 28, 2023, the aggregate outstanding borrowings of our Company is ₹7,772.96 million.

Our Company proposes to utilise an estimated amount of ₹1,360.00 million from the Net Proceeds towards repayment or prepayment, in part or full, of all or a portion of certain borrowings availed by our Company as identified below, and the accrued interest thereon. Further, our Company shall pay the prepayment charges, if any, on the loans identified below, out of the portion of Net Proceeds earmarked for this Object. In the event the Net Proceeds are insufficient for payment of pre-payment penalty or accrued interest, as applicable, such payment shall be made from the internal accruals of our Company. We believed that the repayment or prepayment will help reduce our outstanding indebtedness, debt servicing costs, assist us in maintaining a favourable debt-equity ratio and enable utilisation of funds from our internal accruals for further investment in business growth and expansion. In addition, we believe that this will enable us to raise further resources at competitive rates in the future to fund potential business development opportunities and plans to grow and expand our business in the future.

Owing to the nature of our business and/or the borrowings, we may avail additional facilities or repay certain instalments of our borrowings after the filing of this Red Herring Prospectus. Given the nature of these borrowings and the terms of repayment/prepayment, the aggregate outstanding borrowing amounts may vary from time to time. Further, the amounts outstanding under these borrowings as well as the sanctioned limits are dependent on several factors and may vary with our business cycle with multiple intermediate repayments, drawdowns and enhancement of sanctioned limits. In light of the above, if at the time of filing this Red Herring Prospectus, any of the below mentioned loans are repaid in part or full or refinanced or if any additional credit facilities are availed or drawn down or if the limits under the working capital borrowings are increased, then the table below shall be suitably revised to reflect the revised amounts or loans as the case may be which have been availed by our Company. However, the aggregate amount to be utilised from the Net Proceeds towards repayment/ prepayment of borrowings (including refinanced or additional borrowings availed, if any, or otherwise) by our Company, in part or in full, would not exceed ₹1,360.00 million.

The following table sets forth details of certain borrowings availed by our Company, which are outstanding as on August 28, 2023 out of which our Company may repay/prepay, all or a portion of, any or all of the borrowings, from the Net Proceeds:

(amounts in ₹ million, unless otherwise mentioned)

Name of the lender	Nature of borrowing	Amount sanctioned as at August 28, 2023	Amount outstanding as per books of account as at August 28, 2023	Applicable rate of interest as on August 28, 2023	Tenor as on August 28, 2023	Purpose for which the loan was sanctioned and utilised*	Prepayment penalty/ conditions
State Bank of India	Working capital demand loan	1,000.00	100.00	7.79%	Repayable on demand	Working capital requirements	Nil
HDFC Bank Limited	Term loan	1,000.00	437.47	8.95%	Seven quarterly instalments of ₹62.50 million each	To meet capital expenditure related expenses and re-imbursment of capital expenditure related expenses at the Waghodia plant	Nil
Kotak Mahindra Bank Limited	Working capital demand loan	500.00	140.00	7.90%	Repayable on demand	Working capital requirements	Nil.
Citicorp Finance India Limited	Term loan	600.00	74.45	8.95%	Four quarterly instalments of ₹18.61 million each	Capital expenditure for the enhancement of manufacturing facilities of copper and aluminum wire at Waghodia and Silvassa plant	Prepayment penalty at mutually agreeable rate.
Yes Bank Limited	Working capital demand loan	100.00	100.00	8.00%	Repayable on demand	Working capital requirements	Nil
Federal Bank Limited	Working capital demand loan	400.00	200.00	8.10%	Repayable on demand	Working capital requirements	Prepayment penalty of 2% of the amount prepaid plus GST.
IndusInd Bank Limited	Short term loan	300.00	294.00	7.75%	Repayable on demand	Working capital requirements	Prepayment charge / fee as stipulated by the bank from time to time.
HSBC Bank Limited	Working capital demand loan	1000.00	180.00	8.30%	Repayable on demand	Working capital requirements	Any cancellation or prepayment will be subject to funding penalties at

Name of the lender	Nature of borrowing	Amount sanctioned as at August 28, 2023	Amount outstanding as per books of account as at August 28, 2023	Applicable rate of interest as on August 28, 2023	Tenor as on August 28, 2023	Purpose for which the loan was sanctioned and utilised*	Prepayment penalty/ conditions
							Bank's Discretion
Total		4,900.00	1,525.92				

For details on the borrowings, see "Financial Information" and "Financial Indebtedness" beginning on pages 269 and 377, respectively.

* As certified by report/certificate dated September 6, 2023, issued by our Statutory Auditors, the utilisation of the proceeds of the loans, as indicated above has been towards the purpose availed for, as per the sanction letters / loan agreements of the respective loans.

The selection of borrowings proposed to be repaid or prepaid out of the borrowings provided above has been based on various factors including (i) any conditions attached to the borrowings restricting our ability to prepay the borrowings and time taken to fulfil such requirements, (ii) levy of any prepayment penalties and the quantum thereof, (iii) provisions of any law, rules, regulations governing such borrowings, and (iv) other commercial considerations including, among others, the interest rate on the loan facility, the amount of the loan outstanding and the remaining tenor of the loan.

We also propose to repay / prepay certain borrowings availed by our Company from entities related to the Book Running Lead Managers. Our Company proposes to repay / prepay certain loans availed from Citicorp Finance India Limited and HSBC Bank Limited, which are related to two of the Book Running Lead Managers, Citigroup Global Markets India Private Limited and HSBC Securities and Capital Markets (India) Private Limited. However, Citicorp Finance India Limited and HSBC Bank Limited do not qualify as associates of our Company in terms of the SEBI Merchant Banker Regulations and such borrowings have been sanctioned to our Company as part of their ordinary course of lending business. For details, see "Risk Factors – Internal Risks- A portion of the Net Proceeds may be utilized for repayment or pre-payment of loans taken from Citicorp Finance India Limited and HSBC Bank Limited, which are affiliates of two of the Book Running Lead Managers, Citigroup Global Markets India Private Limited and HSBC Securities and Capital Markets (India) Private Limited." on page 52.

II. General corporate purposes

Our Company proposes to deploy the balance Net Proceeds aggregating to ₹[●] million towards general corporate purposes, subject to such amount not exceeding 25% of the Gross Proceeds from the Fresh Issue, in compliance with the SEBI ICDR Regulations. Such general corporate purposes may include, but are not restricted to strategic initiatives, strengthening marketing capabilities and brand building exercises, meeting ongoing general corporate contingencies, expenses incurred in ordinary course of business, meeting our business requirements, payment of lease liabilities, payment of commission and/or fees to consultants, business development initiatives, employee welfare activities, salaries and wages, administrative expenses, insurance, repairs and maintenance and payments of taxes and duties, and any other purpose in the ordinary course of business as may be approved by the Board or a duly appointed committee from time to time, subject to compliance with applicable laws.

The quantum of utilisation of funds towards each of the above purposes will be determined by our Board, based on the amount actually available under this head and the business requirements of our Company, from time to time. Our Company's management shall have flexibility in utilising surplus amounts, if any. Any unutilised portion of Net Proceeds earmarked towards general corporate purposes may also be utilised to meet any shortfall in the Net Proceeds earmarked for other Objects, subject to applicable law. In addition to the above, our Company may utilise the Net Proceeds towards other expenditure considered expedient and as approved periodically by our Board, subject to compliance with necessary provisions of the Companies Act. In the event that we are unable to utilize the entire amount that we have currently estimated for use out of the Net Proceeds in a Fiscal, we will utilize such unutilized amount(s) in the subsequent Fiscal.

Offer Expenses

The Offer expenses are estimated to be approximately ₹[●] million. Other than (a) audit fees not attributable to the Offer, listing fees and expenses for any product or corporate advertisements consistent with past practice of our Company (other than the expenses relating to the Offer), which will be borne by our Company and (b) fees and expenses in relation to the legal counsel to the Selling Shareholders which shall be borne by the respective Selling Shareholders, all costs, charges, fees and expenses associated with and incurred in connection with the Offer, including Offer advertising, printing, road show expenses, accommodation and travel expenses, stamp, transfer, issuance, documentary, registration, costs for execution and enforcement of the Offer Agreement, Registrar's fees, fees to be paid to the BRLMs, fees and expenses of legal counsel to our Company and the BRLMs, fees and expenses of the auditors, fees to be paid to Sponsor Banks, SCSBs (processing fees and selling commission), brokerage for Syndicate Members, commission to Registered Brokers, Collecting DPs and RTAs, and payments to consultants, and advisors,

shall be shared among our Company and each of the Selling Shareholders in proportion to the number of Equity Shares issued and Allotted by our Company through the Fresh Issue and sold by each of the Selling Shareholders through the Offer for Sale. All such payments shall be made by our Company on behalf of the Selling Shareholders and upon the successful completion of the Offer, the Selling Shareholders agree that they shall, severally and not jointly, reimburse our Company in proportion to their respective proportion of the Offered Shares, for any expenses incurred by our Company on behalf of such Selling Shareholder. It is further clarified that all payments shall be made first by our Company and that each of the Selling Shareholders shall reimburse our Company for respective proportion of the expenses upon the successful completion of the Offer. Further, in the event that the Offer is postponed, withdrawn or abandoned for any reason or in the event that the Offer is not successfully completed, all expenses in relation to the Offer including the fees of the BRLMs and legal counsels and their respective reimbursement for expenses which may have accrued up to the date of such postponement, withdrawal, abandonment or failure as set out in their respective engagement letters or the Offer Agreement, shall be shared proportional to the Fresh Issue and Offer for Sale between our Company and Selling Shareholders and in accordance with applicable laws.

The break-up for the Offer expenses is as follows:

Activity	Estimated expenses ⁽¹⁾ (in ₹million)	As a % of the total estimated Offer expenses ⁽¹⁾	As a % of the total Offer size ⁽¹⁾
BRLMs' fees including underwriting commission, brokerage and selling commission, as applicable	[•]	[•]	[•]
Commission/processing fee for SCSBs, Sponsor Banks, Bankers to the Offer and fee payable to the Sponsor Bank for Bids made by RIBs and Eligible Employees. Brokerage, underwriting commission and selling commission and bidding charges for Members of the Syndicate, Registered Brokers, RTAs and CDPs ⁽²⁾⁽³⁾⁽⁴⁾⁽⁵⁾⁽⁶⁾⁽⁷⁾⁽⁸⁾⁽⁹⁾⁽¹⁰⁾⁽¹¹⁾	[•]	[•]	[•]
Fees payable to the Registrar to the Offer	[•]	[•]	[•]
Fees payable to other parties, including but not limited to Statutory Auditors, Independent Chartered Accountant, industry expert and Independent Chartered Engineer			
Others	[•]	[•]	[•]
- Listing fees, SEBI filing fees, upload fees, BSE & NSE processing fees, book building software fees and other regulatory expenses	[•]	[•]	[•]
- Printing and distribution of issue stationery	[•]	[•]	[•]
- Advertising and marketing expenses	[•]	[•]	[•]
- Fees payable to legal counsels			
- Miscellaneous	[•]	[•]	[•]
Total estimated Offer expenses	[•]	[•]	[•]

(1) Selling commission payable to the SCSBs on the portion for Retail Individual Bidders, Non-Institutional Bidders and Eligible Employees which are directly procured by the SCSBs, would be as follows:

Portion for Retail Individual Bidders*	0.35% of the Amount Allotted* (plus applicable taxes)
Portion for Non-Institutional Bidders*	0.20% of the Amount Allotted* (plus applicable taxes)
Portion for Eligible Employees*	0.25% of the Amount Allotted* (plus applicable taxes)

*Amount Allotted is the product of the number of Equity Shares Allotted and the Offer Price. Selling commission payable to the SCSBs will be determined on the basis of the bidding terminal ID as captured in the Bid Book of BSE or NSE.

No processing fees shall be payable by our Company and the Selling Shareholders to the SCSBs on the applications directly procured by them.

(2) Processing fees payable to the SCSBs on the portion for Retail Individual Bidders, Non-Institutional Bidders and Eligible Employees (excluding UPI Bids) which are procured by the members of the Syndicate/sub-Syndicate/Registered Broker/RTAs/ CDPs and submitted to SCSB for blocking, would be as follows:

Portion for Retail Individual Bidders, Non-Institutional Bidders and Eligible Employees*	₹ 10/- per valid Bid cum Application Form (plus applicable taxes)
--	---

* Processing fees payable to the SCSBs for capturing Syndicate Member/Sub-syndicate (Broker)/Sub-broker code on the ASBA Form for Non-Institutional Bidders and Qualified Institutional Bidders with bids above ₹ 0.5 million would be Rs. 10 plus applicable taxes, per valid application

(3) Selling commission on the portion for Retail Individual Bidders (up to ₹ 0.2 million), Non-Institutional Bidders (from ₹ 0.2 - ₹ 0.5 million) and Eligible Employees which are procured by Members of the Syndicate (including their sub-Syndicate Members), RTAs and CDPs or for

using 3-in-1 type accounts- linked online trading, demat & bank account provided by some of the Registered Brokers which are Members of the Syndicate (including their Sub-Syndicate Members) would be as follows:

Portion for Retail Individual Bidders	0.35% of the Amount Allotted* (plus applicable taxes)
Portion for Non-Institutional Bidders	0.20% of the Amount Allotted* (plus applicable taxes)
Portion for Eligible Employees	0.25% of the Amount Allotted* (plus applicable taxes)

*Amount Allotted is the product of the number of Equity Shares Allotted and the Offer Price.

The selling commission payable to the Syndicate / Sub-Syndicate Members will be determined (i) for RIIs, NIIs and Eligible Employees (upto ₹ 0.5 million), on the basis of the application form number / series, provided that the application is also bid by the respective Syndicate / Sub-Syndicate Member. For clarification, if a Syndicate ASBA application on the application form number / series of a Syndicate / Sub-Syndicate Member, is bid by an SCSB, the selling commission will be payable to the SCSB and not the Syndicate / Sub-Syndicate Member; and (ii) for NIIs (above ₹ 0.5 million), Syndicate ASBA Form bearing SM Code & Sub-Syndicate Code of the application form submitted to SCSBs for Blocking of the Fund and uploading on the Exchanges Platform by SCSBs. For clarification, if a Syndicate ASBA application on the application form number / series of a Syndicate / Sub-Syndicate Member, is bid by an SCSB, the selling commission will be payable to the Syndicate / Sub-Syndicate members and not the SCSB.

Bidding Charges payable to members of the Syndicate (including their sub-Syndicate Members) on the applications made using 3-in-1 accounts would be ₹ 10 plus applicable taxes, per valid application bid by the Syndicate (including their sub- Syndicate Members). Bidding charges payable to SCSBs on the QIB Portion and NIIs (excluding UPI Bids) which are procured by the Syndicate/sub-Syndicate/Registered Broker/RTAs/ CDPs and submitted to SCSBs for blocking and uploading would be ₹ 10 per valid application (plus applicable taxes).

The selling commission and bidding charges payable to Registered Brokers, the RTAs and CDPs will be determined on the basis of the bidding terminal ID as captured in the bid book of BSE or NSE.

Selling commission/ bidding charges payable to the Registered Brokers on the portion for Retail Individual Bidders, Eligible Employees procured through UPI Mechanism and Non-Institutional Bidders which are directly procured by the Registered Broker and submitted to SCSB for processing, would be as follows:

Portion for Retail Individual Bidders, Non-Institutional Bidders and Eligible Employees	₹ 10/- per valid Bid cum Application Form (plus applicable taxes)
---	---

(4) **Uploading Charges**

Bidding charges/ processing fees for applications made by UPI Bidders using the UPI Mechanism would be as under:

Members of the Syndicate / RTAs / CDPs (uploading charges)	₹ 30/- per valid application (plus applicable taxes)
Axis Bank Limited	NIL per valid Bid cum Application Form (plus applicable taxes) The Sponsor Bank shall be responsible for making payments to the third parties such as remitter bank, NPCI and such other parties as required in connection with the performance of its duties under the SEBI circulars, the Syndicate Agreement and other applicable laws.
ICICI Bank Limited	NIL per valid Bid cum Application Form (plus applicable taxes) The Sponsor Bank shall be responsible for making payments to the third parties such as remitter bank, NPCI and such other parties as required in connection with the performance of its duties under the SEBI circulars, the Syndicate Agreement and other applicable laws.

All such commissions and processing fees set out above shall be paid as per the timelines in terms of the Syndicate Agreement and Escrow and Sponsor Banks Agreement.

The processing fees for applications made by UPI Bidders may be released to the remitter banks (SCSBs) only after such banks provide a written confirmation on compliance with SEBI circular no. SEBI/HO/CFD/DIL2/CIR/P/2022/51 dated April 20, 2022 read with SEBI Circular No: SEBI/HO/CFD/DIL2/CIR/P/2021/570 dated June 02, 2021 read with SEBI Circular No: SEBI/HO/CFD/DIL2/CIR/P/2021/2480/M dated March 16, 2021.

All such commissions and processing fees set out above shall be paid as per the timelines in terms of the Syndicate Agreement and the Cash Escrow and Sponsor Bank Agreement.

Interim use of Net Proceeds

Pending utilisation of the Net Proceeds for the purposes described above, our Company will temporarily invest the Net Proceeds only in deposits with one or more scheduled commercial banks included in the Second Schedule of Reserve Bank of India Act, 1934, as may be approved by our Board. In accordance with Section 27 of the Companies Act, 2013, our Company confirms that it shall not use the Net Proceeds for buying, trading or otherwise dealing in shares of any other listed company or for any investment in the equity markets.

Monitoring of utilisation of funds

In terms of Regulation 41 of the SEBI ICDR Regulations, our Company has appointed the Monitoring Agency to monitor the utilisation of the Net Proceeds, including the proceeds proposed to be utilised towards general corporate purposes, prior to filing of this Red Herring Prospectus with the RoC. Our Audit Committee and the Monitoring Agency will monitor the utilisation of the Net Proceeds (including in relation to the utilisation of the Net Proceeds towards the general corporate purposes) and the Monitoring Agency shall submit the report required under Regulation 41(2) of the SEBI ICDR Regulations, on a quarterly basis, until such time as the Net Proceeds have been utilised in full. Our Company undertakes to place the report(s) of the Monitoring Agency on receipt before the Audit Committee without any delay. Our Company will disclose and continue to disclose the utilisation of the Net Proceeds, including interim use under a separate head in its balance sheet for such fiscal periods as required under the SEBI ICDR Regulations, the SEBI Listing Regulations and any other applicable laws or regulations, clearly specifying the purposes for which the Net Proceeds have been utilised, till the time any part of the Fresh Issue proceeds remains unutilised. Our Company will also, in its balance sheet for the applicable fiscal periods, provide details, if any, in relation to all such Net Proceeds that have not been utilised, if any, of such currently unutilised Net Proceeds.

Our Company will also, in its balance sheet for the applicable fiscal periods, provide details, if any, in relation to all such Net Proceeds that have not been utilised, if any, of such currently unutilised Net Proceeds. Further, our Company, on a quarterly basis, shall include the deployment of Net Proceeds under various heads, as applicable, in the notes to our quarterly results.

Pursuant to Regulation 18(3) and Regulation 32(3) of the SEBI Listing Regulations, our Company shall on a quarterly basis disclose to the Audit Committee the uses and application of the Net Proceeds. The Audit Committee shall make recommendations to our Board for further action, if appropriate. Our Company shall, on an annual basis, prepare a statement of funds utilised for purposes other than those stated in this Red Herring Prospectus and place it before our Audit Committee. Such disclosure shall be made only until such time that all the Net Proceeds have been utilised in full. The statement shall be certified by the Statutory Auditor and such certification shall be provided to the Monitoring Agency. Further, in accordance with Regulation 32 of the SEBI Listing Regulations, our Company shall furnish to the Stock Exchanges on a quarterly basis, a statement indicating (i) deviations, if any, in the utilisation of the Net Proceeds from the objects of the Issue as stated above; and (ii) details of category wise variations in the utilisation of the Net Proceeds from the objects of the Issue as stated above.

Variation in Objects

In accordance with Sections 13(8) and 27 of the Companies Act and applicable rules, our Company shall not vary the objects of the Offer without our Company being authorised to do so by the Shareholders by way of a special resolution and such variation will be in accordance with the applicable laws including the Companies Act 2013 and the SEBI ICDR Regulations. In addition, the notice issued to the Shareholders in relation to the passing of such special resolution (the “**Notice**”) shall specify the prescribed details, including justification for such variation and be published and placed on website of our Company, in accordance with the Companies Act, 2013, read with relevant rules. Our Promoters or controlling Shareholders will be required to provide an exit opportunity to such Shareholders who do not agree to the proposal to vary the objects, subject to the provisions of the Companies Act 2013 and in accordance with such terms and conditions, including in respect of pricing of the Equity Shares, in accordance with the Companies Act 2013 and the SEBI ICDR Regulations.

Other confirmations

None of our Directors, Key Managerial Personnel, Promoters, members of our Promoter Group or Group Companies will receive any portion of the Gross Proceeds and there are no material existing or anticipated transactions in relation to utilisation of the Net Proceeds with our Directors, Key Managerial Personnel, Promoters, members of our Promoter Group or Group Companies.

BASIS FOR OFFER PRICE

The Price Band and Offer Price and discount (if any) will be determined by our Company and the Investor Selling Shareholder, in consultation with the Book Running Lead Managers, on the basis of assessment of market demand for the Equity Shares offered through the Book Building Process and on the basis of quantitative and qualitative factors as described below. The face value of the Equity Shares is ₹5 each and the Offer Price is [●] times the face value at the lower end of the Price Band and [●] times the face value at the higher end of the Price Band.

Bidders should read “*Risk Factors*”, “*Our Business*”, “*Restated Consolidated Financial Information*”, “*Other Financial Information*” and “*Management’s Discussion and Analysis of Financial Condition and Results of Operations*” beginning on pages 28, 190, 269, 372 and 379, respectively, to have an informed view before making an investment decision.

Qualitative Factors

We believe that some of the qualitative factors which form the basis for computing the Offer Price are as follows:

- Scaled B2C business in the large and growing wires and cables industry;
- Diverse suite of products driven by our focused research and development efforts with global certifications and accreditations;
- Extensive domestic and global distribution network
- Well recognized consumer brands; and
- Technologically advanced and integrated precision manufacturing facilities.

For further details, see “*Our Business –Strengths*” on page 193.

Quantitative Factors

Certain information presented below, relating to our Company, is derived from the Restated Consolidated Financial Information. For further details, see “*Restated Consolidated Financial Information*” beginning on page 269.

Pursuant to a resolution passed by our Board on March 16, 2023 and a resolution passed by the Shareholders on March 20, 2023, each equity share of face value of ₹10 each has been split into 2 Equity Shares of face value of ₹5 each. Accordingly, the issued, subscribed and paid up capital of our Company was sub-divided from 23,924,074 equity shares of face value of ₹10 each to 47,848,148 equity shares of face value of ₹5 each.

Sub-division of shares are retrospectively considered for the computation of EPS (as defined hereinafter) in accordance with Ind AS 33 for all periods presented and for the computation of Net Asset Value per Equity Share for all periods presented. Our Board of Directors pursuant to a resolution dated March 16, 2023 and Shareholders pursuant to a special resolution dated March 20, 2023, have approved the issuance of 47,848,148 bonus Equity Shares in the ratio of one Equity Share for every one existing fully paid up Equity Share.

Some of the quantitative factors which may form the basis for computing the Offer Price are as follows:

1. Basic and Diluted Earnings Per Equity Share (“EPS”), as adjusted for changes in capital:

As derived from the Restated Consolidated Financial Information:

Financial/Period ended	Basic EPS (in ₹)	Diluted EPS (in ₹)	Weight
Financial Year 2023	17.09	17.07	3
Financial Year 2022	19.26	19.22	2
Financial Year 2021	12.19	12.18	1
Weighted Average	17.00	16.97	
Three months period ended June 30, 2023*	6.69	6.68	
Three months period ended June 30, 2022*	1.63	1.63	

*Not annualized.

Notes:

- (1) Weighted average = Aggregate of year-wise weighted EPS divided by the aggregate of weights i.e. (EPS x Weight) for each year/Total of weights.
- (2) Earnings per Equity Share = Profit for the period/year / Weighted average number of equity shares outstanding during the period/year.
- (3) Basic and diluted Earnings per Equity Share are computed in accordance with Indian Accounting Standard 33.
- (4) The basic and diluted Earnings per Equity Share have been calculated/restated after considering sub-division of Equity Shares of face value of ₹10 each to ₹5 each and issue of bonus shares in the ratio of 1 (one) Equity Share for 1 (one) Equity Share held on the record date as approved by the Board of Directors and Shareholders in their meeting held on March 16, 2023 and March 20, 2023, respectively. Appropriate adjustments have been made for compulsory convertible preference shares and options granted to employees under the ESOP schemes of the Company.
- (5) The face value of each Equity Share is ₹5.

2. Price/Earning (“P/E”) ratio in relation to Price Band of ₹[●] to ₹[●] per Equity Share*:

Particulars	P/E at the lower end of Price Band (no. of times)	P/E at the higher end of Price Band (no. of times)
Based on Basic EPS for Financial Year 2023	[●]	[●]
Based on Diluted EPS for Financial Year 2023	[●]	[●]

*To be updated at the price band stage.

Notes:

(1) P/E ratio has been computed dividing the price per share by Earnings per Equity Share.

3. Industry P/E ratio

Particulars	P/E Ratio
Highest	79.49
Lowest	34.52
Industry Composite	57.57

Notes:

(1) The industry high and low has been considered from the industry peer set provided later in this section. The industry composite has been calculated as the arithmetic average P/E of the industry peer set disclosed in this section.

(2) The industry P/E ratio mentioned above is as per the closing rate as on September 5, 2023 quoted on BSE.

(3) All the financial information for listed industry peers is sourced from the audited financial statements of the relevant companies for Fiscal 2023, as available on the websites of the Stock Exchanges.

4. Return on Net Worth (“RoNW”)

As derived from the Restated Consolidated Financial Information of our Company:

Period ended	RoNW%	Weight
Financial Year 2023	13.66	3
Financial Year 2022	17.29	2
Financial Year 2021	13.10	1
Weighted Average	14.78	-
Three months period ended June 30, 2023*	4.97	-
Three months period ended June 30, 2022*	1.45	-

*Not annualized.

Notes:

(1) Weighted average = Aggregate of year-wise RoNW divided by the aggregate of weights i.e. (RoNW x Weight) for each year/Total of weights.

(2) Net Worth has been defined as restated and consolidated net worth, which is the aggregate value of the paid-up share capital and all reserves created out of the profits and securities premium account and debit or credit balance of profit and loss account, after deducting the aggregate value of the accumulated losses, deferred expenditure and miscellaneous expenditure not written off, as per the restated consolidated statement of assets and liabilities, but does not include reserves created out of revaluation of assets, write-back of depreciation and amalgamation. Further, capital redemption reserve, capital reserve and share suspense account have been excluded when computing other equity since these were not created out of the profits. This a non-GAAP measure. For reconciliation see “Other Financial Information – Reconciliation of Non-GAAP Measures” on page 372.

(3) Return on Net Worth (%) = Profit for the period/ year / Net Worth at the end of the period/year. This a non-GAAP measure. For reconciliation see “Other Financial Information – Reconciliation of Non-GAAP Measures” on page 372.

5. Net Asset Value per Equity Share of face value of ₹ 5 each

Net Asset Value per Equity Share	(₹)
As on March 31, 2023	125.19
As on June 30, 2023	134.57
After the Offer	At Floor Price: [●]
	At Cap Price: [●]
Offer Price	[●]

Notes:

(1) Net Asset Value per Equity Share (in ₹) = Net Worth at the end of the period/year / Weighted number of equity shares outstanding at the end of the period/year. This a non-GAAP measure. For reconciliation see “Other Financial Information – Reconciliation of Non-GAAP Measures” on page 372.

(2) Net Worth has been defined as restated and consolidated net worth, which is the aggregate value of the paid-up share capital and all reserves created out of the profits and securities premium account and debit or credit balance of profit and loss account, after deducting the aggregate value of the accumulated losses, deferred expenditure and miscellaneous expenditure not written off, as per the restated consolidated statement of assets and liabilities, but does not include reserves created out of revaluation of assets, write-back of depreciation and amalgamation. Further, capital redemption reserve, capital reserve and share suspense account have been excluded when computing other equity since these were not created out of the profits. This a non-GAAP measure. For reconciliation see “Other Financial Information – Reconciliation of Non-GAAP Measures” on page 372.

(3) The Offer Price per Equity Share will be determined on conclusion of the Book Building Process.

6. Comparison of accounting ratios with listed industry peers

Name of Company	Face Value Per Share (₹)	Closing price on September 5, 2023 (₹)	Total Income, for Fiscal 2023 (in ₹ million)	EPS (₹)		P/E	Return on Net Worth (%)	Net Asset Value per Equity Share (₹)
				Basic	Diluted			
R R Kabel Limited	5	N.A.	56,336.40	17.09	17.07	N.A.	13.66	125.19
Peer Group								
Havells India Limited	1	1,360.05	1,70,884.40	17.11	17.11	79.49	16.18	105.75
Polycab India Limited	10	5,293.70	1,42,411.04	84.87	84.61	62.57	19.23	445.25
KEI Industries Limited	2	2,628.35	69,399.53	52.94	52.86	49.72	18.44	287.07
Finolex Cables Limited	2	1,138.00	45,988.50	32.97	32.97	34.52	11.54	285.76
V-Guard Industries Limited	1	314.80	41,424.83	4.38	4.35	72.37	11.76	37.20
Crompton Greaves Consumer Electricals Limited	2	303.95	69,363.90	7.29	7.27	41.81	15.33	48.85
Bajaj Electricals Limited	2	1,173.05	55,051.14	18.80	18.77	62.50	11.34	165.74

Notes:

- (1) All the financial information for listed industry peers mentioned above is on an audited consolidated basis and sourced from the audited financial statements of the relevant companies for Fiscal 2023, as available on the websites of the Stock Exchanges.
- (2) The basic and diluted Earnings per Equity Share for the year presented for R R Kabel Limited have been calculated/restated after considering the share split and bonus issue pursuant to a resolution passed by our Board dated March 16, 2023 and a special resolution passed by our Shareholders dated March 20, 2023, respectively. Appropriate adjustments have been made for compulsory convertible preference shares and options granted to employees under the ESOP scheme of the Company.
- (3) Basic and diluted EPS refers to the Basic EPS sourced from the publicly available financial results of the respective company for Fiscal 2023.
- (4) P/E Ratio has been computed based on the closing market price (September 5, 2023) of equity shares on BSE, divided by the Diluted EPS provided under Note 3 above.
- (5) Return on Net worth (%) = Profit for the year / Net Worth at the end of the year
- (6) Net Asset Value per Equity Share (in ₹) = Net worth at the end of the year / Weighted number of equity shares outstanding at the end of the year.
- (7) N.A. – Not Applicable
- (8) Return on Net Worth and Net Asset Value per Equity Share are non-GAAP measures. For reconciliation see “Other Financial Information – Reconciliation of Non-GAAP Measures” on page 372.

7. Key Performance Indicators (“KPIs”)

The tables below set forth the details of our certain financial data based on our Restated Consolidated Financial Information, certain non-GAAP measures and KPIs that our Company considers have a bearing for arriving at the basis for Offer Price. All the financial data based on our Restated Consolidated Financial Information, certain non-GAAP measures and KPIs disclosed below have been approved and confirmed by a resolution of our Audit Committee dated August 30, 2023. Further, the Audit Committee has noted that no KPIs have been disclosed to any new investors in the last three year preceding the date of this Red Herring Prospectus. The KPIs that have been consistently used by the management to analyse, track and monitor the operational and financial performance of the Company and were presented in the past meetings of the Board and Audit Committee or shared with the shareholders and potential investors during the three years preceding the date of this Red Herring Prospectus, which have been consequently identified as relevant and material KPIs and are disclosed in this “Basis for Offer Price” section, have been identified and verified by the management of our Company in consultation with the Independent Chartered Accountant in accordance with SEBI ICDR Regulations.

A list of certain financial data, based on our Restated Consolidated Financial Information and as certified by the Independent Chartered Accountant by way of their certificate dated September 6, 2023, is set out below for the indicated period:

Particulars	Three months ended June 30,		As at / for the Fiscal ended March 31,		
	2023	2022	2023	2022	2021
Revenue from operations (in ₹ million)	15,973.14	12,359.10	55,992.00	43,859.36	27,239.41
Revenue from operations (Outside India) (in ₹ million)	4,303.73	3,436.30	12,701.90	10,075.54	5,867.66
Advertisement and business promotion expenses (in ₹ million)	188.15	134.45	851.43	491.29	259.61
Profit for the year / period (in ₹ million)	743.48	181.42	1,898.72	2,139.37	1,353.98
Segment revenue from operations (wires and cables) (in ₹ million)	14,230.82	11,058.27	49,585.32	41,112.71	25,202.47
Segment revenue from operations (FMEG) (in ₹ million)	1,742.32	1,300.83	6,406.68	2,746.65	2,036.94
Revenue from operations growth (%)	29.24	-*	27.66	61.01	-*
Segment revenue from operations (wires and cables) growth (%)	28.69	-*	20.61	63.13	-*

Particulars	Three months ended June 30,		As at / for the Fiscal ended March 31,		
	2023	2022	2023	2022	2021
Segment revenue from operations (FMEG) growth (%)	33.94	-*	133.25	34.84	-*
Profit after tax growth (%) ¹	309.81	-*	(11.25)	58.01	-*
Trade Receivables days ²	35	39	36	39	56
Inventory days ³	60	69	63	63	77
Trade Payable days ⁴	31	24	24	14	25

Notes:

1. Profit after tax is Profit for the period / year.

2. Trade receivable days is defined as average trade receivables divided by revenue from operations multiplied by 365 for fiscal years and 91 days for three months period.

3. Inventory days is defined as average inventory divided by Cost of Goods Sold multiplied by 365 for fiscal years and 91 days for three months period. Cost of Goods Sold have been defined as cost of materials consumed plus purchase of stock-in-trade plus changes in inventories of finished goods, stock-in-trade, work-in-progress and scrap.

4. Trade payable days is defined as average trade payables divided by Cost of Goods Sold multiplied by 365 for fiscal years and 91 days for three months period. Cost of Goods Sold have been defined as cost of materials consumed plus purchases of stock-in-trade plus changes in inventories of finished goods, stock-in-trade, work-in-progress and scrap.

Average: Average means (opening plus closing) divided by two.

A list of our certain non-GAAP measures, is set out below for the indicated period:

Particulars	Three months ended June 30,		As at / for the Fiscal ended March 31,		
	2023	2022	2023	2022	2021
PAT Margin (%) ¹	4.61	1.46	3.37	4.83	4.93
EBITDA (in ₹ million) ²	1,298.99	471.82	3,577.04	3,537.27	2,532.40
EBITDA Margin (%) ³	8.05	3.79	6.35	7.98	9.22
EBITDA Growth (%) ⁴	175.31	-*	1.12	39.68	-*
Return on Capital Employed (%) ⁵	5.95	1.86	15.57	17.41	13.59
Return on Equity (%) ⁶	5.05	1.43	14.22	18.63	13.88
Debt to Equity ratio (times) ⁷	0.26	0.39	0.36	0.42	0.48

Notes:

1. PAT Margin is calculated as follows: Profit for the period / year divided by total income.

2. EBITDA is calculated as follows: profit for the year/ period plus finance costs plus tax expense plus depreciation and amortization expense.

3. EBITDA Margin is calculated as follows: EBITDA divided by total income.

4. EBITDA Growth is calculated as follows: (EBITDA of current period / year minus EBITDA of previous period / year) divided by EBITDA of previous period / year.

5. Return on Capital Employed is calculated as follows: Profit for the period/ year plus finance cost plus tax expenses (EBIT) divided by (Tangible Net Worth plus Total Debt plus Deferred Tax Liabilities). EBIT is not annualized.

6. Return on Equity is calculated as follows: (Profit for the period/year less preference dividend) divided by average equity. For the purposes of calculation of Return on Equity for the three months ended June 30, 2023 and June 30, 2022, profit for the period/year is not annualized.

7. Debt to Equity ratio is calculated as follows: Total Debt divided by equity.

Total Debt: Total Debt is non-current borrowings plus current borrowings.

Equity: Equity is equity share capital plus instrument entirely equity in nature plus other equity.

Average: Average means (opening plus closing) divided by two.

Tangible Net Worth: Equity share capital plus instrument entirely equity in nature plus other equity minus capital redemption reserve minus capital reserve minus share suspense account minus other intangible assets minus intangible assets under development

For reconciliation of certain non-GAAP measures, see “Other Financial Information – Reconciliation of Non-GAAP Measures” on page 372.

Further, the following KPIs have been certified by Bhagwagar Dalal and Doshi, Chartered Accountants, pursuant to their certificate dated September 6, 2023, for the indicated period:

Particulars	Three months ended June 30,		As at / for the Fiscal ended March 31,		
	2023	2022	2023	2022	2021
Working Capital Cycle (days) ¹	64	84	75	88	108
B2C Sales (%)	73.60	71.82	76.68	76.91	79.55
Network of Distributors (numbers)	3,450	2,631	3,296	1,844	1,423
Dealers (numbers)	3,656	3,173	3,444	3,092	2,810
Retailers (numbers)	114,851	67,811	106,626	58,872	30,570

1. Working Capital Cycle is defined as trade receivable days plus inventory days less trade payable days.

For details of other performance indicators disclosed elsewhere in this Red Herring Prospectus, see “*Our Business*” and “*Management’s Discussion and Analysis of Financial Condition and Results of Operations*” beginning on pages 190 and 379, respectively.

Subject to applicable law, the Company confirms that it shall continue to disclose all the above financial data based on the Restated Consolidated Financial Information, certain non-GAAP measures and KPIs included in this “*Basis for Offer Price*” section, on a periodic basis, at least once in a year (or for any lesser period as determined by the Board of our Company), for a duration that is at least the later of (i) one year after the date of listing of the Equity Shares on the Stock Exchanges; or (ii) till the utilization of the Net Proceeds as disclosed under “*Objects of the Offer*” section on page 113.

8. Description on the historic use of the certain financial data based on Restated Consolidated Financial Information, certain non-GAAP measures and KPIs by our Company to analyze, track or monitor the operational and/or financial performance of our Company

In evaluating our business, we consider and use certain financial data based on Restated Consolidated Financial Information, certain non-GAAP measures and KPIs, as presented above, as a supplemental measure to review and assess our financial and operating performance. The presentation of these certain financial data based on Restated Consolidated Financial Information, certain non-GAAP measures and KPIs is not intended to be considered in isolation or as a substitute for the restated summary statement. Some of these certain financial data based on Restated Consolidated Financial Information, certain non-GAAP measures and KPIs are not defined under Ind AS and are not presented in accordance with Ind AS. These certain financial data based on Restated Consolidated Financial Information, certain non-GAAP measures and KPIs have limitations as analytical tools. Further, these certain financial data based on Restated Consolidated Financial Information, certain non-GAAP measures and KPIs may differ from the similar information used by other companies and hence their comparability may be limited. Therefore, these metrics should not be considered in isolation or construed as an alternative to Ind AS measures of performance or as an indicator of our operating performance, liquidity, profitability or results of operation. Although these certain financial data based on Restated Consolidated Financial Information, certain non-GAAP measures and KPIs are not a measure of performance calculated in accordance with applicable accounting standards, our Company’s management believes that it provides an additional tool for investors to use in evaluating our ongoing operating results, when taken collectively with financial measures prepared in accordance with Ind AS. For further details, please see “*Risk Factors – We have presented certain supplemental information of our performance and liquidity which is not prepared under or required under Ind AS.*” on page 59.

Explanations for the certain financial data based on Restated Consolidated Financial Information

Certain financial data	Explanations
Revenue from operations	Revenue from Operations is used by our management to track the revenue profile of the business and in turn helps assess the overall financial performance of our Company and size of our business.
Revenue from operations (Outside India)	Revenue from operations (Outside India) is used by our management to track the revenue profile from the exports undertaken by the Company and in turn helps assess the overall financial performance undertaken through exports by our Company.
Segment revenue from operations (wires and cables)	Segment revenue from operations (wires and cables) provides information regarding the growth of the wires and cables segment for the respective period.
Segment revenue from operations (FMEG)	Segment revenue from operations (FMEG) is used by our management to track the revenue profile of the FMEG segment and helps assess the financial performance of the FMEG segment.
Advertisement and business promotion expenses	Advertisement and business promotion expenses is the cost companies incurred to market their products or services to consumers. This expense is incurred in order to boost sales and revenue through marketing or promotion of the products.
Profit for the year / period	Profit for the year / period provides information regarding the overall profitability of the business.
Revenue from operations growth	Revenue from Operations growth provides information regarding the growth of our business for the respective period.
Profit after tax growth	Profit after tax growth provides information regarding the growth of our operational performance for the respective period.
Segment revenue from operations (wires and cables) growth	Segment revenue from operations (wires and cables) growth provides information regarding the growth of the wires and cables segment for the respective period.
Segment revenue from operations (FMEG) growth	Segment revenue from operations (FMEG) growth provides information regarding the growth of the FMEG segment for the respective period.
Trade Receivables days	Trade Receivables days is the average number of days required for a company to receive payments from its customers.
Inventory days	Inventory days is the average number of days required for a company to convert its inventory into sales.
Trade Payable days	Trade Payable days is the average number of days required for a company to pay its suppliers.

Explanations for certain non-GAAP measures

Certain non-GAAP measures	Explanations
EBITDA	EBITDA provides information regarding the operational efficiency of the business.
EBITDA Margin	EBITDA Margin is an indicator of the operational profitability and financial performance of our business.
EBITDA Growth	EBITDA growth provides information regarding the growth of our operational performance for the respective period.
PAT Margin	PAT Margin is an indicator of the overall profitability and financial performance of our business.
Return on Capital Employed	Return on capital employed provides how efficiently our Company generates earnings from the capital employed in the business.
Return on Equity	Return on equity provides how efficiently our Company generates profits from shareholders' funds.
Debt to Equity ratio	Debt / Equity Ratio is used to measure the financial leverage of the Company and provides comparison benchmark against peers.

Explanations for the KPIs

KPIs	Explanations
B2C Sales	Company product's end use determines whether the sale is through a B2B or B2C channel. According to Technopak, B2C sales provide higher gross margins as compared to B2B sales.
Working Capital Cycle	Working Capital Cycle is the time it takes to convert net current assets and current liabilities into cash.
Network of Distributors, Dealers, Retailers	The network of Distributors, Dealers, Retailers is used to demonstrate the extensive domestic and global distribution network of the Company.

9. Comparison with Listed Industry Peers

While our peers listed in India (mentioned below), like us, operate in the same industry and may have similar offerings or end use applications, our business may be different in terms of differing business models, different product verticals serviced or focus areas or different geographical presence or serving certain segments or sub-segments of our customer base.

Particulars	R R Kabel Limited	Havells India Limited	Polycab India Limited	KEI Industries Limited	Finolex Cables Limited	V-Guard Industries Limited	Crompton Greaves Consumer Electricals Limited	Bajaj Electricals Limited
Revenue from operations (in ₹ million)	55,992.00	169,107.30	141,077.78	69,123.30	44,811.10	41,260.44	68,696.10	54,296.65
Revenue from operations (Outside India) (in ₹ million)	12,701.90	4,885.80	13,835.23	5,892.48	N.A.	51.58	N.A.	N.A.
Advertisement and business promotion expenses (in ₹ million)	851.43	4,374.00	1,244.04	215.19	N.A.	892.05	968.60	1,348.11
Profit for the year / period (in ₹ million)	1,898.72	10,717.30	12,915.16	47,734.20	4,342.90	1,890.47	4,764.00	2,161.85
Segment revenue from operations (wires and cables) (in ₹ million)	49,585.32	55,326.00	123,202.82	48,205.09	36,835.10	N.A.	N.A.	N.A.
Segment revenue from operations (FMEG) (in ₹ million)	6,406.68	70,329.40	12,404.00	N.A.	N.A.	27,928.39	57,908.40	48,873.16
Revenue from operations growth (%)	27.66	21.32	15.60	20.71	18.92	N.A.	27.35	12.80
Segment revenue from operations (wires and cables) growth (%)	20.61	19.17	14.14	(9.87)	3.09	N.A.	N.A.	N.A.
Segment revenue from operations (FMEG) growth (%)	133.25	12.46	(1.11)	N.A.	N.A.	5.09	7.75	11.42
Profit after tax growth (%)	(11.25)	(10.43)	52.34	26.96	59.63	(17.24)	(17.63)	73.77
Trade Receivables days ¹	36	17	41	87	17	46	36	101
Inventory days ²	63	108	82	80	87	113	61	110
Trade Payable days ³	24	77	50	65	23	73	91	122
PAT Margin (%) ^{4#}	3.37	6.27	9.07	6.88	9.44	4.56	6.87	3.93
EBITDA (in ₹ million) ^{5#}	3,577.04	17,768.50	19,854.40	7,337.93	6,271.00	3,363.53	8,372.50	4,335.41
EBITDA Margin (%) ^{6#}	6.35	10.40	13.94	10.57	13.64	8.12	12.07	7.88
EBITDA Growth (%) ^{7#}	1.12	(6.87)	46.51	21.62	25.44	(4.17)	2.58	48.46
Return on Capital Employed (%) ^{8#}	15.57	26.48	25.95	24.61	12.52	18.78	56.52	22.26
Return on Equity (%) [#]	14.22	16.97	21.11	20.21	10.47	12.52	15.02	11.97
Debt to Equity ratio (times) ^{9#}	0.36	0.00	0.02	0.05	0	0.26	0.30	0
Working Capital Cycle (days) ¹⁰	75	45	66	97	64	88	11	52
B2C Sales (%)	76.68	N.A.	46,334.33	N.A.	N.A.	N.A.	N.A.	N.A.
Network of								
Distributors (numbers)	3,296	N.A.	4,300+	1,900+	5,000+	N.A.	N.A.	700+
Dealers (numbers)	3,444	~17,000				N.A.	N.A.	
Retailers (numbers)	106,626	222,000	205,000+	N.A.	175,000	60,000+	150,000+	200,000+

These are non-GAAP measures. For reconciliation see "Other Financial Information – Reconciliation of Non-GAAP Measures" on page 372.

Notes:

1. Trade receivable days is defined as average trade receivables divided by revenue from operations multiplied by 365 for fiscal years and 91 days for three months period.

2. *Inventory days is defined as average inventory divided by Cost of Goods Sold multiplied by 365 for fiscal years and 91 days for three months period . Cost of Goods Sold have been defined as cost of materials consumed plus purchase of stock-in-trade plus changes in inventories of finished goods, stock-in-trade, work-in-progress and scrap.*
3. *Trade payable days is defined as average trade payables divided by cost of goods sold multiplied by 365 for fiscal years and 91 days for three months period. Cost of Goods Sold have been defined as cost of materials consumed plus purchases of stock-in-trade plus changes in inventories of finished goods, stock-in-trade, work-in-progress and scrap.*
4. *PAT Margin is calculated as follows: Profit for the period / year divided by total income.*
5. *EBITDA is calculated as follows: profit for the year/ period plus finance costs plus tax expense plus depreciation and amortization expense.*
6. *EBITDA Margin is calculated as follows: EBITDA divided by total income.*
7. *EBITDA Growth is calculated as follows: (EBITDA of current period / year minus EBITDA of previous period / year) divided by EBITDA of previous period / year.*
8. *Return on Capital Employed is calculated as follows: Profit for the period/ year plus finance cost plus tax expenses (EBIT) divided by (Tangible Net Worth plus Total Debt plus Deferred Tax Liabilities). EBIT is not annualized. For reconciliation of Tangible Net Worth, see "Other Financial Information" on page 372.*
9. *Debt to Equity ratio is calculated as follows: Total Debt divided by equity.*
10. *Working Capital Cycle is defined as trade receivable days plus inventory days less trade payable days.*

All the financial information for listed industry peers mentioned above is on a consolidated basis and sourced from the audited financial statements of the relevant companies Fiscal 2023 as available on the websites of the Stock Exchanges

11. **Price per share of the Company (as adjusted for corporate actions, including sub-division of equity shares and bonus issuances) based on primary issuances of Equity Shares or convertible securities (excluding Equity Shares issued under the ESOP Schemes and issuance of Equity Shares pursuant to a bonus issue) during the 18 months preceding the date of this Red Herring Prospectus, where such issuance is equal to or more than 5% of the fully diluted paid-up share capital of the Company in a single transaction or multiple transactions combined together over a span of rolling 30 days (“Primary Issuances”)**

Our Company has not issued any Equity Shares or convertible securities (“**Security(ies)**”) (excluding Equity Shares issued under the ESOP Schemes or Equity Shares issued pursuant to a bonus issue) during the 18 months preceding the date of this Red Herring Prospectus, where such issuance is equal to or more than 5% of the fully diluted paid-up share capital of our Company (calculated based on the pre-Offer capital before such transaction/s and excluding employee stock options granted but not vested), in a single transaction or multiple transactions combined together over a span of rolling 30 days.

12. **Price per share of the Company (as adjusted for corporate actions, including sub-division of equity shares and bonus issuances) based on secondary sale or acquisition of Equity Shares or convertible securities (excluding gifts) involving any of the Promoters, members of the Promoter Group, Selling Shareholders or Shareholders with rights to nominate directors during the 18 months preceding the date of filing of this RHP, where the acquisition or sale is equal to or more than 5% of the fully diluted paid-up share capital of our Company, in a single transaction or multiple transactions combined together over a span of rolling 30 days (“Secondary Transactions”)**

There have been no secondary sale/ acquisitions of Equity Shares or any convertible securities (“**Security(ies)**”), where the Promoter, members of the Promoter Group, Selling Shareholders or the Shareholder(s) having the right to nominate director(s) in the Board of Directors of our Company are a party to the transaction (excluding gifts), during the 18 months preceding the date of this Red Herring Prospectus, where either acquisition or sale is equal to or more than 5% of the fully diluted paid up share capital of our Company (calculated based on the pre-Offer capital before such transaction/s and excluding employee stock options granted but not vested), in a single transaction or multiple transactions combined together over a span of rolling 30 days.

13. **Since there are no such transactions to report under 10 and 11, the following are the details of price per share of the Company basis the last five primary or secondary transactions (secondary transactions where Promoters, members of the Promoter Group, Selling Shareholders, or Shareholder(s) having the right to nominate Director(s) on our Board, are a party to the transaction), not older than three years prior to the date of this Red Herring Prospectus irrespective of the size of transactions:**

Primary transactions:

Except as disclosed below, there have been no primary transactions in the last three years preceding where the Promoters, Promoter Group, Selling Shareholders, or shareholder(s) having the right to nominate director(s) on our Board are a party to the transaction, in the last three years preceding the date of this Red Herring Prospectus:

1. Equity Shares

Date of allotment of equity shares	Nature of allotment	Nature of consideration	No. of Equity Shares transferred	Issue price per equity share (in ₹)	Names of allottees/ shareholders
December 23, 2020	Allotment pursuant to the Scheme of Amalgamation 2020	Other than cash	2,115,192 ⁽¹⁾⁽²⁾	N.A.	Allotment of 44 equity shares to Tribhuvanprasad Rameshwarlal Kabra, 8,302 equity shares to Mahendra Kumar Kabra HUF, 16,000 equity shares to Jag-Bid Finvest Private Limited, 16,218 equity shares to Late Umadevi Tribhuvanprasad Kabra, 16,259 equity shares to Mahhesh Tribhuvanprasad Kabra, 16,260 equity shares to Kirtidevi Shreegopal Kabra, 16,261 equity shares to Rajesh Shreegopal Kabra, 87,116 equity shares to Ram Ratna Research and Holdings Private Limited, 103,116 equity shares to Mahendrakumar Rameshwarlal Kabra, 124,611 equity shares to Hemant Mahendrakumar Kabra, and 124,611 equity shares to Sumeet Mahendrakumar Kabra. For details in relation to the scheme of amalgamation, see “ <i>History and Certain Corporate Matters – Details regarding material acquisitions or divestments of business or undertakings, mergers, amalgamations or revaluation of assets in the last ten years</i> ”, on page 238.
August 26, 2023	Conversion of Preference Shares to Equity Shares in the ratio of four Equity Shares for every one Preference Shares held	Other than cash	15,372,560	N.A.	Allotment of 11,584,704 Equity Shares to TPG Asia VII SF Pte. Ltd., 505,048 Equity Shares to Dovetail India Fund, 252,524 Equity Shares to Quest Portfolio Services Private Limited, 505,048 Equity Shares to Value Quest S C A L E Fund, 151,512 Equity Shares to Hemang Raichand Dharamshi, 101,008 Equity Shares to Deepak Valji Gala, 505,048 Equity Shares to Jagdish Naresh Master, 505,048 Equity Shares to Ashoka India Equity Investment Trust PLC, 353,532 Equity Shares to Founders Collective Fund, 101,008 Equity Shares to Emerge Capital Opportunities Scheme, and 808,080 Equity Shares to Think India Opportunities Master Fund LP.

Date of allotment of equity shares	Nature of allotment	Nature of consideration	No. of Equity Shares transferred	Issue price per equity share (in ₹)	Names of allottees/ shareholders
Weighted average cost of acquisition (WACA) (primary transactions) (₹ per Equity Share)				N.A.	

*As certified by the Independent Chartered Accountant, by way of their certificate dated September 6, 2023.

- Pursuant to a resolution passed by our Board on March 16, 2023 and a resolution passed by the Shareholders on March 20, 2023, each equity share of face value of ₹10 each has been split into 2 Equity Shares of face value of ₹5 each. Accordingly, the issued, subscribed and paid up capital of our Company was sub-divided from 23,924,074 equity shares of face value of ₹10 each to 47,848,148 equity shares of face value of ₹5 each.
- Our Board of Directors pursuant to a resolution dated March 16, 2023 and Shareholders pursuant to a special resolution dated March 20, 2023, have approved the issuance of 47,848,148 bonus Equity Shares in the ratio of one Equity Share for every one existing fully paid up Equity Share.

2. Preference Shares

Date of allotment of preference shares	Nature of allotment	Nature of consideration	Number of preference shares	Face value per preference share (in ₹)	Issue price per preference share (in ₹)	Name of allottees/ shareholder
December 23, 2020	Allotment pursuant to the Scheme of Amalgamation 2020	Other than cash	140,568	1,080.33	N.A.	Allotment of 140,568 Preference Shares to TPG Asia VII SF Pte. Ltd. For details in relation to the scheme of amalgamation, see "History and Certain Corporate Matters – Details regarding material acquisitions or divestments of business/undertakings, mergers, amalgamation, any revaluation of assets, etc. in the last 10 years", on page 238.
Weighted average cost of acquisition (WACA) (primary transactions) (₹ per Preference Share)					N.A.	

*As certified by the Independent Chartered Accountant, by way of their certificate dated September 6, 2023.

Secondary transactions:

Except as disclosed below, there have been no secondary transactions where the Promoters, Promoter Group, Selling Shareholders, or shareholder(s) having the right to nominate director(s) on our Board are a party to the transaction, in the last three years preceding the date of this Red Herring Prospectus:

Date of transfer	Name of transferor	Name of transferee	No. of Preference Shares transferred	No. of Equity Shares transferred / converted	Total Consideration (in ₹)	Price per Equity Share
December 2, 2022	Sanjay Narnarayan Taparia	Shreegopal Rameshwarlal Kabra	-	40,000 ⁽¹⁾⁽²⁾	13,500,000	337.50 ⁽¹⁾⁽²⁾
		Kabra Shreegopal Rameshwarlal (HUF)	-	40,000 ⁽¹⁾⁽²⁾	13,500,000	337.50 ⁽¹⁾⁽²⁾
		Kishori Dinesh Modani	-	54,400 ⁽¹⁾⁽²⁾	18,360,000	337.50 ⁽¹⁾⁽²⁾
August 11, 2023	TPG Asia VII SF Pte. Ltd.	SBI Life Insurance Company Limited	-	1,010,101	999,999,990	990.00
		Value Quest S C A L E Fund	126,262	505,048 ⁽³⁾	499,997,520	990.00 ⁽³⁾
		Jagdish Naresh Master	126,262	505,048 ⁽³⁾	499,997,520	990.00 ⁽³⁾
		Founders Collective Fund	88,383	353,532 ⁽³⁾	349,996,680	990.00 ⁽³⁾
		Quest Portfolio Services Private Limited	63,131	252,524 ⁽³⁾	249,998,760	990.00 ⁽³⁾
		Hemang Raichand Dharamshi	37,878	151,512 ⁽³⁾	149,996,880	990.00 ⁽³⁾
		Deepak Valji Gala	25,252	101,008 ⁽³⁾	99,997,920	990.00 ⁽³⁾
		Emerge Capital Opportunities Scheme	25,252	101,008 ⁽³⁾	99,997,920	990.00 ⁽³⁾
		Dovetail India Fund-Class 6 Shares	126,262	505,048 ⁽³⁾	499,997,520	990.00 ⁽³⁾
August 14, 2023	TPG Asia VII SF Pte. Ltd.	Think India Opportunities Master Fund LP	202,020	808,080 ⁽³⁾	799,999,200	990.00 ⁽³⁾
		Ashoka India Equity Investment Trust Plc	126,262	505,048 ⁽³⁾	499,997,520	990.00 ⁽³⁾
August 28, 2023	Sumeet Mahendrakumar Kabra	Ram Ratna Infrastructure Private Limited	-	100,000	99,000,000	990.00
	Gaurishankar Satyanarayan Loya	Ram Ratna Infrastructure Private Limited	-	10,000	9,900,000	990.00

Date of transfer	Name of transferor	Name of transferee	No. of Preference Shares transferred	No. of Equity Shares transferred / converted	Total Consideration (in ₹)	Price per Equity Share
	Gaurishankar Satyanarayan Loya	Sarita Jhawar	-	5,000	4,950,000	990.00
	Gaurishankar Satyanarayan Loya	KGR Worldwide Solutions LLP	-	105,000	103,950,000	990.00
	Anant Satyanarayan Loya	KGR Worldwide Solutions LLP	-	120,000	118,800,000	990.00
	Satyanarayan Loya HUF	KGR Worldwide Solutions LLP	-	120,000	118,800,000	990.00
Weighted average cost of acquisition (WACA) (secondary transactions) (₹ per Equity Share)						973.74

* As certified by the Independent Chartered Accountant, by way of their certificate dated September 6, 2023.

The above table does not consider transfers pursuant to gifts and transmission.

- Pursuant to a resolution passed by our Board on March 16, 2023 and a resolution passed by the Shareholders on March 20, 2023, each equity share of face value of ₹10 each has been split into 2 Equity Shares of face value of ₹5 each. Accordingly, the issued, subscribed and paid up capital of our Company was sub-divided from 23,924,074 equity shares of face value of ₹10 each to 47,848,148 equity shares of face value of ₹5 each.
- Our Board of Directors pursuant to a resolution dated March 16, 2023 and Shareholders pursuant to a special resolution dated March 20, 2023, have approved the issuance of 47,848,148 bonus Equity Shares in the ratio of one Equity Share for every one existing fully paid up Equity Share.
- Pursuant to resolution passed by our Board at their meeting held on August 26, 2023, Preference Shares were converted to Equity Shares in the ratio of four Equity Shares for every one Preference Shares held.

14. **The Floor Price is [●] times and the Cap Price is [●] times the weighted average cost of acquisition based on primary issuances/secondary transactions as disclosed in paragraph 12 above, are set below:**

Types of transactions	Weighted average cost of acquisition (₹ per share)#	Floor price (i.e. ₹ [●]*)	Cap price (i.e. ₹ [●]*)
Weighted average cost of acquisition (WACA) of Primary Issuances	N.A.	[●]* times	[●]* times
Weighted average cost of acquisition (WACA) of Secondary Transactions	973.74	[●]* times	[●]* times

* To be updated at Prospectus.

As certified by the Independent Chartered Accountant, by way of their certificate dated September 6, 2023.

15. **Justification for Basis of Offer price**

- The following provides a detailed explanation for the Offer Price/Cap Price being [●] times of weighted average cost of acquisition of Equity Shares that were issued by our Company or acquired or sold by our Promoters, the Promoter Group or other shareholders with rights to nominate directors by way of primary and secondary transactions as disclosed in paragraph 12 above, in the last 18 months preceding the date of this Red Herring Prospectus compared to our Company's KPIs and financial ratios for the three month period ended June 30, 2023 and for the Financial Years 2023, 2022 and 2021

[●]*

*To be included on finalization of Price Band.

- The following provides an explanation to the Cap Price being [●] times of weighted average cost of acquisition of Equity Shares that were issued by our Company or acquired by our Promoters, the Promoter Group or other shareholders with rights to nominate directors by way of primary and secondary transactions as disclosed in paragraph 12 above, in the last 18 months preceding the date of this Red Herring Prospectus in view of external factors, if any

[●]*

*To be included on finalization of Price Band.

The Offer Price of ₹[●] has been determined by our Company and the Investor Selling Shareholder, in consultation with the BRLMs, on the basis of the demand from investors for the Equity Shares through the Book Building process. Investors should read the abovementioned information along with "Risk Factors", "Our Business" and "Summary of Restated Consolidated Financial Information" beginning on pages 28, 190 and 68, respectively, to have a more informed view.

STATEMENT OF SPECIAL TAX BENEFITS

STATEMENT OF SPECIAL TAX BENEFITS AVAILABLE TO THE COMPANY AND ITS SHAREHOLDERS UNDER THE APPLICABLE LAWS IN INDIA

The Board of Directors

R R Kabel Limited

Ram Ratna House, Victoria Mill Compound
Pandurang Budhkar Marg,
Worli, Mumbai- 400 013
Maharashtra, India

Subject: Statement of possible special tax benefits (“the Statement”) available to R R Kabel Limited (“the Company”) and its shareholders prepared in accordance with the requirement under Schedule VI – Part A - Clause (9) (L) of Securities and Exchange Board of India (Issue of Capital and Disclosure Requirements) Regulations, 2018, as amended (“the ICDR Regulations”)

This Statement is issued in accordance with the Engagement Letter dated 21 February 2023.

We hereby report that the enclosed Annexure II prepared by the Company, initialed by us for identification purpose, states the possible special-tax benefits available to the Company and its shareholders under direct and indirect taxes (together “**the Tax Laws**”), presently in force in India as on the signing date, which are defined in Annexure I. These possible special tax benefits are dependent on the Company and its shareholders fulfilling the conditions prescribed under the relevant provisions of the Tax Laws. Hence, the ability of the Company and its shareholders to derive these possible special tax benefits is dependent upon their fulfilling such conditions, which is based on business imperatives the Company may face in the future and accordingly, the Company and its shareholders may or may not choose to fulfill.

The benefits discussed in the enclosed Annexure II cover the possible special tax benefits available to the Company and its shareholders and do not cover any general tax benefits available to the Company and its shareholders. Further, the preparation of the enclosed Annexure II and its contents is the responsibility of the Management of the Company. We were informed that the Statement is only intended to provide general information to the investors and is neither designed nor intended to be a substitute for professional tax advice. In view of the individual nature of the tax consequences and the changing tax laws, each investor is advised to consult his or her own tax consultant with respect to the specific tax implications arising out of their participation in the proposed initial public offering of equity shares of the Company (the “**Proposed Offer**”) particularly in view of the fact that certain recently enacted legislation may not have a direct legal precedent or may have a different interpretation on the possible special tax benefits, which an investor can avail. Neither we are suggesting nor advising the investors to invest money based on the Statement. We conducted our examination in accordance with the “Guidance Note on Reports or Certificates for Special Purposes (Revised 2016)” (the “**Guidance Note**”) issued by the Institute of Chartered Accountants of India. The Guidance Note requires that we comply with ethical requirements of the Code of Ethics issued by the Institute of Chartered Accountants of India.

We have complied with the relevant applicable requirements of the Standard on Quality Control (SQC) 1, Quality Control for Firms that Perform Audits and Reviews of Historical Financial information, and Other Assurance and Related Services Engagements. We do not express any opinion or provide any assurance as to whether:

- i) the Company and its shareholders will continue to obtain these possible special tax benefits in future; or
- ii) the conditions prescribed for availing the possible special tax benefits where applicable, have been/would be met with.

The contents of the enclosed Annexures are based on the information, explanation and representations obtained from the Company and on the basis of our understanding of the business activities and operations of the Company.

Our views expressed herein are based on the facts and assumptions indicated to us. No assurance is given that the revenue authorities/courts will concur with the views expressed herein. Our views are based on the existing provisions of the Tax Laws and its interpretation, which are subject to change from time to time. We do not assume responsibility to update the views consequent to such changes. We shall not be liable to the Company for any claims, liabilities or expenses relating to this assignment except to the extent of fees relating to this assignment, as finally judicially determined to have resulted primarily from bad faith or intentional misconduct. We will not be liable to the Company and any other person in respect of this Statement, except as per applicable law.

We hereby give consent to include this Statement in the Red Herring Prospectus, the Prospectus and in any other material used in connection with the Proposed Offer and submission of this Statement to the Securities and Exchange Board of India, the stock exchanges where the Equity Shares of the Company are proposed to be listed and the Registrar of Company of Maharashtra at Mumbai in connection with the Proposed Offer, as the case may be, and it is not to be used, referred to or distributed for any other purpose without our prior written consent.

For **B S R & Co. LLP**
Chartered Accountants
Firm's Registration No: 101248W/W-100022

Rupen Shah
Partner
Membership No.: 116240
ICAI UDIN: 23116240BGWVFQ5052
Place: Mumbai
Date: September 6, 2023

ANNEXURE I

LIST OF DIRECT AND INDIRECT TAX LAWS ('TAX LAWS')

Sr. No	Details of tax laws
1.	Income-tax Act, 1961 and Income-tax Rules, 1962
2.	Central Goods and Services Tax Act, 2017
3.	Integrated Goods and Services Tax Act, 2017
4.	State Goods and Services Tax Act, 2017
5.	Customs Act, 1962 and Customs Tariff Act, 1975 read with respective rules, circulars and notifications made thereunder
6.	Foreign Trade Policy 31 March 2023

ANNEXURE II

STATEMENT OF POSSIBLE SPECIAL TAX BENEFITS AVAILABLE TO THE COMPANY AND ITS SHAREHOLDERS UNDER THE APPLICABLE DIRECT AND INDIRECT TAXES (“TAX LAWS”)

Outlined below are the Possible Special Tax Benefits available to the Company and its shareholders under the Tax Laws. These Possible Special Tax Benefits are dependent on the Company and its shareholders fulfilling the conditions prescribed under the Tax Laws. Hence, the ability of the Company and its shareholders to derive the Possible Special Tax Benefits is dependent upon fulfilling such conditions, which are based on business imperatives it faces in the future, it may or may not choose to fulfill.

UNDER THE TAX LAWS

A. Special tax benefits available to the Company

a) Direct Tax Laws

- Deduction under Section 80JJAA of the Act

Subject to fulfilment of prescribed conditions, the Company is entitled to claim deduction, under the provisions of Section 80JJAA of the Income-tax Act, 1961, of an amount equal to thirty per cent of additional employee cost (relating to specified category of employees) incurred in the course of business in the previous year, for three assessment years including the assessment year relevant to the previous year in which such employment is provided.

- Section 80M of the Act

Under Section 80M of the Income-tax Act, 1961, in respect of dividend received by the Company from any other domestic company or a foreign company or a business trust and included in the Company's total income, a deduction is available to the Company of an amount equal to so much of the dividends received from such other domestic company or foreign company or business trust as does not exceed the amount of dividend distributed by the Company on or before one month prior to due date of furnishing the income-tax return for the relevant year.

b) Indirect Tax Laws

- The Company is availing FTA's (Foreign Trade Agreements) benefits of basic duty exemption in terms of Foreign Trade Policy 2023 and complying conditions as per applicable provisions.
- The Company is availing the benefit on import of goods under Advance Authorization Scheme in terms of Foreign Trade Policy 2023, getting duty exemption and complying conditions as per applicable provisions.
- The Company has opted to export the goods without payment of Integrated GST under a Letter of Undertaking for the Financial Year 2023-24 and is entitled to claim refund of accumulated ITC on such exports in terms of GST law.
- The Company is claiming rebate of taxes/duties on inputs under Remission of Duties and Taxes on Exported Products (RoDTEP) scheme at the applicable rates.
- The Company is claiming duty drawback of duty paid on import of materials used in manufacture of exported goods under Section 75 of the Customs Act 1962.

B. Special tax benefits available to Shareholders

There are no special tax benefits available to the Shareholders under the Tax Laws.

NOTES:

1. The above is as per the current Tax Laws prevalent as on the date of issuance of this certificate.
2. The above Statement of possible special tax benefits sets out the provisions of Tax Laws in a summary manner only and is not a complete analysis or listing of all the existing and potential tax consequences of the purchase, ownership and disposal of equity

shares of the Company.

3. This Statement does not discuss any tax consequences in any country outside India of an investment in the equity shares of the Company. The shareholders / investors in any country outside India are advised to consult their own professional advisors regarding possible income tax consequences that apply to them under the laws of such jurisdiction.
4. The possible special tax benefits are subject to conditions and eligibility criteria which need to be examined for tax implications.
5. The tax benefits discussed in the Statement are not exhaustive and are only intended to provide general information to the investors and hence, is neither designed nor intended to be a substitute for professional tax advice. In view of the individual nature of the tax consequences and the changing tax laws, each investor is advised to consult his or her own tax consultant with respect to the specific tax implications arising out of their participation in the issue.
6. The stated benefits will be available only to the sole/ first named holder in case the equity shares are held by joint holders.
7. In respect of non-residents, the tax rates and the consequent taxation mentioned above will be further subject to any benefits available under the relevant Double Taxation Avoidance Agreement, if any, between India and the country in which the non-resident has fiscal domicile.

For **R R Kabel Limited**

Shreegopal Rameshwarlal Kabra

Managing Director

Place: Mumbai

Date: September 6, 2023

CERTAIN U.S. FEDERAL INCOME TAX CONSIDERATIONS

The following is a discussion of certain U.S. federal income tax consequences to U.S. Holders (defined below) of acquiring, owning and disposing of Equity Shares, but it does not purport to be a comprehensive discussion of all tax considerations that may be relevant to a particular person's decision to acquire Equity Shares. This discussion applies only to a U.S. Holder that acquires Equity Shares in the Offer and that owns Equity Shares as capital assets for U.S. federal income tax purposes. This discussion is based on the U.S. Internal Revenue Code of 1986, as amended (the "Code"), its legislative history, U.S. Treasury regulations promulgated under the Code, and administrative rulings and judicial interpretations thereof, in each case as in effect of the date of this Red Herring Prospectus. Except as expressly described herein, this discussion does not address the U.S. federal income tax consequences that may apply to U.S. Holders under the Convention Between the Government of the United States of America and the Government of the Republic of India for the Avoidance of Double Taxation and the Prevention of Fiscal Evasion with Respect to Taxes on Income (the "Treaty"). All of the foregoing authorities are subject to change, which change could apply retroactively and could affect the tax consequences described below. No ruling will be sought from the U.S. Internal Revenue Service (the "IRS") with respect to any statement or conclusion in this discussion, and there can be no assurance that the IRS will not challenge such statement or conclusion in the following discussion or, if challenged, that a court will uphold such statement or conclusion.

In addition, this discussion does not describe all of the tax consequences that may be relevant in light of a U.S. Holder's particular circumstances, including any U.S. state, local or non-U.S. tax law, the Medicare tax on net investment income, and any estate or gift tax laws, and it does not describe differing tax consequences applicable to U.S. Holders subject to special rules, such as:

- certain banks or financial institutions;
- regulated investment companies and real estate investment trusts;
- dealers or traders in securities that use a mark-to-market method of tax accounting;
- insurance companies;
- persons holding Equity Shares as part of a hedge, straddle, conversion, constructive sale, wash sale, integrated transaction or similar transaction;
- persons liable for the alternative minimum tax;
- persons required for U.S. federal income tax purposes to accelerate the recognition of any item of gross income with respect to our Equity Shares as a result of such income being recognized on an applicable financial statement;
- persons whose functional currency for U.S. federal income tax purposes is not the U.S. dollar;
- entities or arrangements classified as partnerships or pass-through entities for U.S. federal income tax purposes or holders of equity interests therein;
- tax-exempt entities, "individual retirement accounts" or "Roth IRAs";
- certain U.S. expatriates;
- persons that own, directly, indirectly or constructively, ten percent (10%) or more of the total voting power or value of all of our outstanding stock; or
- persons owning Equity Shares in connection with a trade or business conducted outside the United States.

U.S. Holders should consult their tax advisors concerning the U.S. federal, state, local and non-U.S. tax consequences of acquiring, owning and disposing of Equity Shares in their particular circumstances.

For purposes of this discussion, a "U.S. Holder" is a person that, for U.S. federal income tax purposes, is a beneficial owner of Equity Shares and is:

- an individual citizen or resident of the United States;
- a corporation, or other entity taxable as a corporation, created or organized in or under the laws of the United States, any state therein or the District of Columbia;
- an estate, the income of which is subject to U.S. federal income taxation regardless of its source; or
- a trust if a court within the United States is able to exercise primary supervision over its administration and one or more United States persons have the authority to control all substantial decisions of the trust or otherwise if the trust has a valid election in effect under current Treasury regulations to be treated as a United States person.

If an entity or arrangement that is classified as a partnership for U.S. federal income tax purposes owns Equity Shares, the U.S. federal income tax treatment of a partner will generally depend on the status of the partner and the status and activities of the partnership. Partnerships owning Equity Shares and partners in such partnerships should consult their tax advisors as to the particular U.S. federal income tax consequences of acquiring, owning and disposing of the Equity Shares.

THE DISCUSSION OF U.S. FEDERAL INCOME TAX CONSIDERATIONS SET OUT BELOW IS FOR GENERAL INFORMATION ONLY. ALL PROSPECTIVE PURCHASERS SHOULD CONSULT THEIR TAX ADVISORS CONCERNING THE TAX CONSEQUENCES OF THE ACQUISITION, OWNERSHIP, OR DISPOSITION OF EQUITY SHARES IN LIGHT OF THEIR PARTICULAR CIRCUMSTANCES, INCLUDING THE APPLICABILITY AND EFFECT OF OTHER FEDERAL, STATE, LOCAL, NON-U.S. AND OTHER TAX LAWS, INCLUDING THE TREATY, AND POSSIBLE CHANGES IN TAX LAW.

Taxation of Distributions

Subject to the discussion below under “—Passive Foreign Investment Company Rules,” the gross amount of any distribution of cash or property paid with respect to our Equity Shares (including any amounts withheld in respect of Indian taxes), will generally be included in a U.S. Holder’s gross income as dividend income on the date actually or constructively received to the extent such distribution is paid out of our current or accumulated earnings and profits (as determined under U.S. federal income tax principles). Distributions in excess of our current and accumulated earnings and profits will be treated first as a non-taxable return of capital, thereby reducing the U.S. Holder’s adjusted tax basis in our Equity Shares (but not below zero), and thereafter as either long-term or short-term capital gain depending upon whether the U.S. Holder held our Equity Shares for more than one year as of the time such distribution is actually or constructively received. Because we do not prepare calculations of our earnings and profits using U.S. federal income tax principles, it is expected that distributions generally will be taxable to U.S. Holders as dividends, and taxable at ordinary income tax rates.

Dividends on our Equity Shares generally will not be eligible for the dividends-received deduction generally available to U.S. corporations with respect to dividends received from other U.S. corporations. With respect to certain non-corporate U.S. Holders, including individual U.S. Holders, dividends will be taxed at the lower capital gains rate applicable to “qualified dividend income,” provided that (i) our Company is eligible for the benefits of the Treaty, (ii) our Company is not a PFIC (as discussed below under “—Passive Foreign Investment Company Rules”) for its taxable year in which the dividend is paid and the preceding taxable year, and (iii) certain holding period and other requirements are met. The amount of any dividend paid in Rupee will be the U.S. dollar value of the Rupee calculated by reference to the spot rate of exchange in effect on the date of actual or constructive receipt, regardless of whether the payment is in fact converted into U.S. dollars on such date. U.S. Holders should consult their own tax advisors regarding the treatment of any foreign currency gain or loss.

A U.S. Holder may be entitled, subject to certain limitations, to a credit against its U.S. federal income tax liability, or to a deduction, if elected, in computing its U.S. federal taxable income, for non-refundable non-U.S. income taxes withheld from dividends at a rate not exceeding the rate provided in the Treaty (if applicable). Recently issued U.S. Treasury regulations require non-U.S. income tax laws to meet certain requirements in order for taxes imposed under such laws to be eligible for credit. Our Company has not determined whether these requirements have been met with respect to any such non-U.S. withholding taxes. A recent notice from the IRS indicates, however, that the U.S. Department of the Treasury (“**Treasury**”) and the IRS are considering proposing amendments to such U.S. Treasury Regulations and allows, subject to certain conditions, taxpayers to defer the application of many aspects of such U.S. Treasury regulations for taxable years ending on or before December 31, 2023 (the notice also indicates that the Treasury and the IRS are considering whether, and under what conditions, to provide additional temporary relief for later taxable years). For purposes of the foreign tax credit limitation, dividends paid by our Company generally will constitute foreign source income in the “passive category income” basket. The rules relating to the foreign tax credit or deduction, if elected, are complex and U.S. Holders should consult their tax advisors concerning their availability in their particular circumstances.

Sale or Other Taxable Disposition of Equity Shares

Subject to the discussion below under “—Passive Foreign Investment Company Rules,” a U.S. Holder generally will recognize gain or loss for U.S. federal income tax purposes on the sale, exchange or other taxable disposition of our Equity Shares in an amount equal to the difference between the amount realized on the disposition and the U.S. Holder’s adjusted tax basis in the Equity Shares disposed of, in each case as determined in U.S. dollars. Such gain or loss generally will be capital gain or loss and will be long-term capital gain or loss if the U.S. Holder’s holding period for the Equity Shares exceeds one year. Long-term capital gains of certain non-corporate U.S. Holders (including individuals) are generally eligible for reduced rates of taxation. The deductibility of capital losses is subject to limitations.

A U.S. Holder’s initial tax basis in our Equity Shares will be the U.S. dollar value of the Rupee denominated purchase price determined on the date of purchase, and the amount realized on a sale, exchange or other taxable disposition of our Equity Shares will be the U.S. dollar value of the payment received determined on the date of disposition. If our Equity Shares are treated as traded on an “established securities market,” a cash method U.S. Holder or, if it elects, an accrual method U.S. Holder, will determine the U.S. dollar value of (i) the cost of such Equity Shares by translating the amount paid at the spot rate of exchange on the settlement date of the purchase, and (ii) the amount realized by translating the amount received at the spot rate of exchange on the settlement date of the sale, exchange or other taxable disposition. Such an election by an accrual method U.S. Holder must be applied consistently from year to year and cannot be revoked without the consent of the IRS. Accrual-method U.S. Holders that do not elect to be treated as cash-method taxpayers for this purpose may have a foreign currency gain or loss for U.S. federal income tax purposes, which in general will be treated as U.S.-source ordinary income or loss. U.S. Holders should consult their advisors as to the U.S. federal income tax consequences of the receipt of Rupee.

If any Indian tax is imposed on the sale or other disposition of our Equity Shares, a U.S. Holder’s amount realized will include the gross amount of the proceeds of the sale or other disposition before deduction of the Indian tax. U.S. Holders should consult their own tax advisors concerning the creditability or deductibility of any Indian income tax imposed on the disposition of Equity Shares in their particular circumstances.

Passive Foreign Investment Company Rules

In general, a corporation organized outside the United States will be treated as a passive foreign investment company (“**PFIC**”) for U.S. federal income tax purposes in any taxable year in which (a) 75% or more of its gross income is passive income (the “**income**”

test”) or (b) 50% or more of its assets by value either produce passive income or are held for the production of passive income, based on the quarterly average of the fair market value of such assets (the “asset test”). For this purpose, “gross income” generally includes all sales revenues less the Cost of Goods Sold, plus income from investments and from incidental or outside operations or sources, and “passive income” generally includes, for example, dividends, interest, certain rents and royalties, certain gains from the sale of stock and securities, and certain gains from commodities transactions. For purposes of the PFIC income test and asset test described above, if our Company owns, directly or indirectly, 25% or more of the total value of the outstanding shares of another corporation, our Company will be treated as if it (a) held a proportionate share of the assets of such other corporation and (b) received directly a proportionate share of the income of such other corporation.

Based on the nature of our business, the composition of our income and assets, the value of our assets, our intended use of the proceeds from the Offer, and the expected price of our Equity Shares, we do not believe that we were a PFIC for the taxable year ended March 31, 2023, or expect that we will be a PFIC for our current taxable year or in the foreseeable future. However, because a determination of whether a company is a PFIC must be made annually after the end of each taxable year and our Company’s PFIC status for each taxable year will depend on facts, including the composition of Company’s income and assets and the value of Company’s assets (which may be determined in part by reference to the market value of the Equity Shares) at such time, there can be no assurance that our Company will not be a PFIC for the current or any future taxable year. Our U.S. counsel expresses no opinion with respect to our PFIC status for our past, current or future taxable years. If our Company is a PFIC for any taxable year during which a U.S. Holder holds Equity Shares and any of our Company’s non-U.S. subsidiaries is also a PFIC, such U.S. Holder will be treated as owning a proportionate amount (by value) of the shares of the lower-tier PFIC for purposes of the application of these rules. U.S. Holders are urged to consult their tax advisors about the application of the PFIC rules to any of our Company’s subsidiaries.

Generally, if our Company is a PFIC for any taxable year during which a U.S. Holder holds Equity Shares, the U.S. Holder may be subject to adverse tax consequences. Generally, gain recognized by a U.S. Holder upon a disposition (including, under certain circumstances, a pledge) of Equity Shares by the U.S. Holder would be allocated ratably over the U.S. Holder’s holding period for such Equity Shares. The amounts allocated to the taxable year of disposition and to years before our Company became a PFIC would be taxed as ordinary income. The amount allocated to each other taxable year would be subject to tax at the highest rate in effect for that taxable year for individuals or corporations, as appropriate, and an interest charge would be imposed on the tax attributable to the allocated amount. Further, to the extent that any distribution received by a U.S. Holder on the Equity Shares exceeds 125% of the average of the annual distributions on such Equity Shares received during the preceding three years or the U.S. Holder’s holding period, whichever is shorter, that distribution would be subject to taxation in the same manner as gain, described immediately above. Certain elections may be available that would result in alternative treatments of the Equity Shares if our Company was a PFIC.

If our Company was a PFIC for any year during which a U.S. Holder owned Equity Shares, our Company would generally continue to be treated as a PFIC with respect to such U.S. Holder for all succeeding years during which such U.S. Holder held the Equity Shares, even if our Company ceased to meet the threshold requirements for PFIC status.

If a U.S. Holder owns our Equity Shares during any year in which we are a PFIC, the U.S. Holder generally will be required to file an IRS Form 8621 annually with respect to our Company, generally with the U.S. Holder’s U.S. federal income tax return for that year unless specified exceptions apply.

U.S. Holders should consult their tax advisors regarding our PFIC status for any taxable year and the potential application of the PFIC rules.

Information Reporting and Backup Withholding

Payments of dividends and sales proceeds from a sale, exchange or other taxable disposition (including redemption) of our Equity Shares that are made within the United States, by a U.S. payor or through certain U.S.-related financial intermediaries to a U.S. Holder generally are subject to information reporting, unless the U.S. Holder is a corporation or other exempt recipient, and if required, demonstrates that fact. In addition, such payments may be subject to backup withholding, unless (1) the U.S. Holder is a corporation or other exempt recipient or (2) the U.S. Holder provides a correct taxpayer identification number and certifies that it is not subject to backup withholding in the manner required.

Backup withholding is not an additional tax. The amount of any backup withholding from a payment to a U.S. Holder will generally be allowed as a credit against the U.S. Holder’s U.S. federal income tax liability or may entitle the U.S. Holder to a refund, provided that the required information is timely furnished to the IRS.

Foreign Financial Asset Reporting

Certain U.S. Holders who are individuals or certain specified entities that own “specified foreign financial assets” with an aggregate value in excess of U.S.\$50,000 (and in some circumstances, a higher threshold) may be required to report information relating to the Equity Shares by attaching a complete IRS Form 8938, Statement of Specified Foreign Financial Assets (which requires U.S. Holders to report “foreign financial assets,” which generally include financial accounts held at a non-U.S. financial institution, interests in non-U.S. entities, as well as stock and other securities issued by a non-U.S. person), to their tax return for each year in which they hold our Equity Shares, subject to certain exceptions (including an exception for our Equity Shares held in accounts maintained by U.S. financial institutions). U.S. Holders should consult their tax advisors regarding their reporting obligations with respect to their acquisition, ownership, and disposition of the Equity Shares.

SECTION IV: ABOUT OUR COMPANY

INDUSTRY OVERVIEW

The industry information contained in this section is derived from the industry report titled “Consumer Electrical Industry in India” dated August 30, 2023, which is exclusively prepared for the purposes of the Offer and issued by Technopak and is commissioned and paid for by our Company (“**Technopak Report**”). Industry sources and publications generally state that the information contained therein has been obtained from sources generally believed to be reliable, but their accuracy, completeness and underlying assumptions are not guaranteed and their reliability cannot be assured. Industry publications are also prepared based on information as at specific dates and may no longer be current or reflect current trends. Accordingly, investment decisions should not be based on such information. Forecasts, estimates, predictions, and other forward-looking statements contained in the Technopak Report are inherently uncertain because of changes in factors underlying their assumptions, or events or combinations of events that cannot be reasonably foreseen. Actual results and future events could differ materially from such forecasts, estimates, predictions, or such statements. In making any decision regarding the transaction, the recipient should conduct its own investigation and analysis of all facts and information contained in the prospectus and the recipient must rely on its own examination and the terms of the transaction, as and when discussed. See “Certain Conventions, Presentation of Financial, Industry and Market Data– Industry and Market Data” on page 24. **In this section, please note that numbers or multiples denoting (a) a ‘lakh’ is equal to 1,00,000 and 10 lakhs is equal to 1 million or one million; and (b) a ‘crore’ is equal to 10,000,000 and 100 lakhs or one crore is equal to 10 million.**

In this section, unless the context requires, references to “we”, “us”, “our” and similar terms are to RR Kabel Limited, on a consolidated basis.

Section 1: Overview of Global and Indian Economy

Macroeconomic Overview - GDP and GDP Growth

India is ranked fifth in the world in terms of nominal gross domestic product (“**GDP**”) for Fiscal 2022 and is the third largest economy in the world in terms of purchasing power parity (“**PPP**”). India is expected to become an approximately US\$ 5 trillion economy by Fiscal 2026 and the third largest economy by Fiscal 2030 surpassing Germany and Japan.

Exhibit 1.1: GDP at current prices (In US\$ trillion) and GDP ranking of key global economies (calendar year (“CY”))

Country	Rank in GDP (CY 2021)	Rank in GDP (PPP)	CY 2010	% Share	CY 2015	% Share	CY 2021	% Share	CY 2022	% Share	CY 2024P	CAGR (2010-2021)	CAGR (2021-2024P)
USA	1	2	15	22.5%	18.2	24.2%	23.3	24.1%	25.4	25.1%	27.4	4.1%	5.6%
China	2	1	6.1	9.2%	11.1	14.8%	17.7	18.3%	18.8	18.6%	21.1	10.2%	6.0%
Japan	3	4	5.7	8.6%	4.9	5.9%	4.9	5.1%	5.0	5.0%	5.3	-1.4%	2.7%
Germany	4	5	3.4	5.1%	3.7	4.5%	4.3	4.5%	4.5	4.5%	5.1	2.2%	5.9%
India	5	3	0.9	1.4%	1.6	2.3%	3.0	3.1%	3.4	3.4%	4.2	11.6%	11.9%
UK	6	10	2.5	3.8%	2.6	3.9%	2.9	3.0%	3.2	3.2%	3.4	1.4%	5.5%
Brazil	12	8	2.2	3.3%	1.8	2.4%	1.6	1.7%	1.8	1.8%	2	-2.9%	7.7%
Russia	11	6	1.5	2.3%	1.4	1.9%	1.8	1.9%	1.9	1.9%	1.9	1.7%	1.8%
World	-	-	66.6	-	75.2	-	96.5	-	101.0	-	111.9	3.4%	5.1%

Source: World Bank Data, IMF, RBI, Technopak Analysis. CY 2021 for India refers to Fiscal 2022 data and so on.

India’s nominal GDP has grown at a compounded annual growth rate (“**CAGR**”) of 11.7% between CY 2010 and CY 2021 and is expected to continue the trend by growing at a CAGR of 11.9% between CY 2021 and CY 2024.

From Fiscal 2010 until Fiscal 2022, the Indian economy's growth rate has been more than twice as that of the world economy and it is expected to sustain this growth momentum in the long term. India's nominal GDP grew by 16.7% in Fiscal 2022 followed by a 10.4% growth in Fiscal 2023 and is expected to grow further and reach US\$ 4.2 trillion by Fiscal 2025. Between Fiscal 2022 and Fiscal 2025, India’s real GDP is expected to grow at a CAGR of 6.5%, which compares favorably to the world average (2.7%) and with other major economies, including China (4.0%), UK (1.4%), Japan (1.4%), Germany (0.6%) and the USA (1.1%) for the period between CY 2021 and CY 2024. It is also expected that the growth trajectory of the Indian economy will enable India to be among the top 3 global economies by Fiscal 2030. Several factors are likely to contribute to its economic growth in the long run. These include favorable demographics, reducing dependency ratio, rapidly rising education levels, steady urbanization, the growing young and working population, information technology (“**IT**”) revolution, increasing penetration of mobile and internet infrastructure, government policies, increasing aspirations and affordability.

Exhibit 1.2: Nominal GDP growth (%) – US, China, Japan, Germany, India (CY)

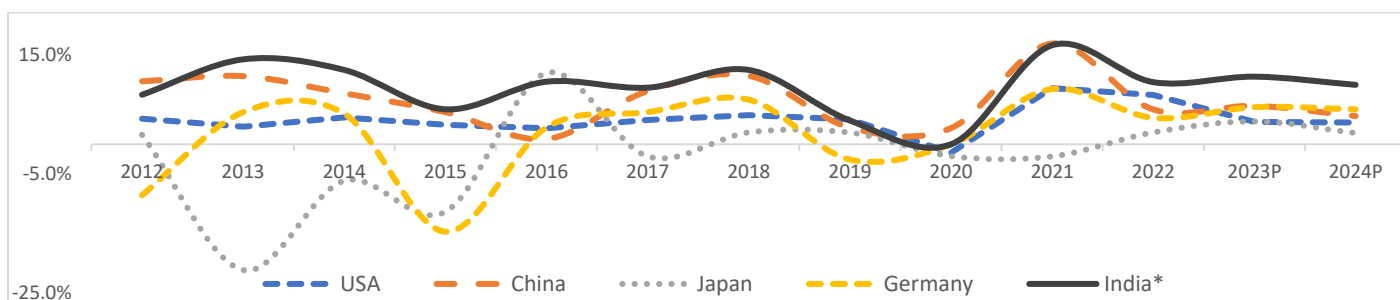

Nominal GDP Growth (CY)	2012	2013	2014	2015	2016	2017	2018	2019	2020	2021	2022	2023P	2024P
USA	4.3%	3.0%	4.5%	3.3%	2.7%	4.1%	4.9%	4.2%	-1.4%	9.4%	8.3%	3.8%	3.6%
China	10.6%	11.5%	8.6%	5.4%	0.9%	8.9%	11.5%	2.8%	2.7%	16.9%	5.9%	6.5%	4.7%
Japan	1.6%	-21.2%	-6.1%	-11.4%	12.0%	-2.0%	2.0%	2.0%	-2.0%	-2.0%	2.0%	3.8%	1.9%
Germany	-8.6%	5.4%	5.1%	-14.7%	2.9%	5.4%	7.5%	-2.6%	0.0%	9.3%	4.4%	6.3%	5.9%
India*	8.3%	14.3%	12.5%	5.9%	10.5%	9.5%	12.5%	4.0%	0.0%	16.7%	10.4%	11.4%	10.0%

Source: India Data from RBI, other countries data from World Bank, Future growth rate from OECD Data, Technopak Analysis; *For India, CY 2012 represents Fiscal 2013 and so on.

Per Capita Income Growth

Income growth, presented by Gross National Income (“GNI”) is defined as the total amount of money earned by a country’s businesses and individuals. While India’s gross national income grew at a CAGR of 8.1% for the period Fiscal 2015 to Fiscal 2022, GNI per capita for countries such as USA, China, Japan, Germany and UK grew at a CAGR of 3.5%, 6.9%, -0.6%, 0.9% and 0.0% between CY 2014 and CY 2021. India’s GNI is expected to continue the growth momentum with a CAGR of 12.6% from Fiscal 2022 to Fiscal 2025. Growing GNI is one of the strongest drivers for higher private consumption trends. The GNI per capita for the top five economies of the world for CY 2021 was USA (US\$ 70,930), China (US\$ 11,880), Japan (US\$ 42,650), Germany (US\$ 51,200) and the UK (US\$ 44,480) as compared to India’s GNI of US\$ 2,128 (₹ 170,222) for a similar period of Fiscal 2022.

Exhibit 1.3: India's GNI Per Capita (₹) (Current Prices) and year-on-year (“Y-o-Y”) growth trend (%) in Fiscal Year

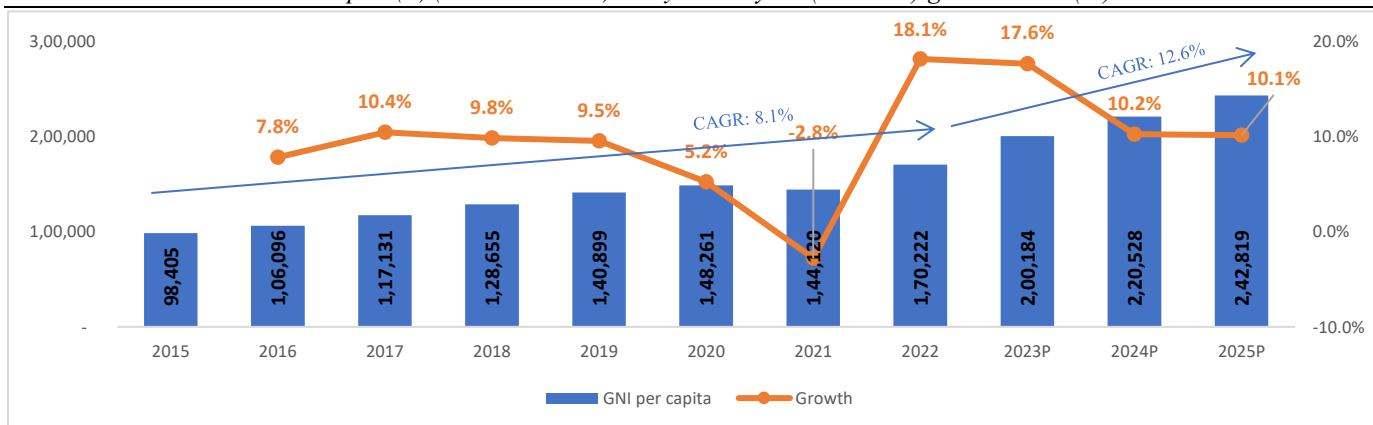

Source: RBI, IMF projections

Key characteristics of the Indian economy

1. Demographic profile of India

India has one of the youngest populations globally compared to other leading economies. The median age in India is estimated at 28.7 years for Fiscal 2022 as compared to 38.5 years and 38.4 years in the United States and China, respectively, and is expected to remain under 30 years until Fiscal 2030. With a growing young population, the demand for premiumization is also growing. With more young people joining the workforce and earning higher salaries, there is a corresponding increase in disposable incomes, and hence the ability to afford premium products and services.

Exhibit 1.4: Median Age (in years): Key Emerging and Developed Economies in (CY 2022)

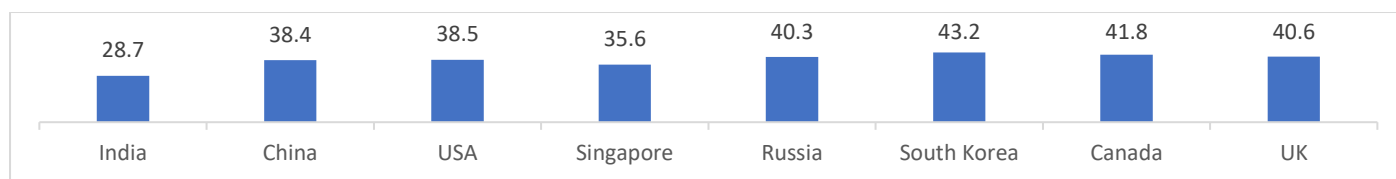

Source: World Population Review, Technopak Analysis

India is the second most populated country in the world, home to 1.4 billion people which is about one sixth of the world's population as on CY 2022. 54% of the total population is between 15 to 49 years while 80% of the population is below 50 years old. This indicates that India's youth and working age population contribute to the positive demographics.

2. Private Consumption

GDP growth in India is expected to be driven by rising private final consumption expenditure. India is a consumption driven economy where the share of domestic consumption is measured as private final consumption expenditure ("PFCE"). This private consumption expenditure comprises both goods (such as food, lifestyle, home and pharmacy) and services (such as food services, education and healthcare). A high share of private consumption to GDP has the advantage of insulating India from volatility in the global economy. It also implies that sustainable economic growth directly translates into sustained consumer demand for goods and services. India's domestic consumption has grown at a CAGR of 10.4% between Fiscal 2017 and Fiscal 2022, compared to 4.3% and 9.6% in the USA and China, respectively during the similar period of CY 2016 and CY 2021.

Exhibit 1.5: Private Final Consumption Expenditure Growth (%) (CY)

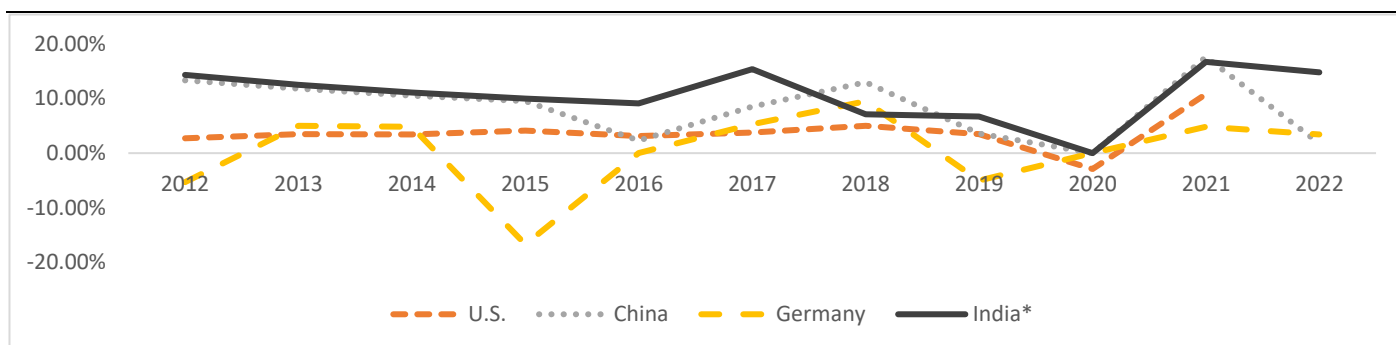

Private Final Consumption Expenditure growth (%) (CY)

Country	2012	2013	2014	2015	2016	2017	2018	2019	2020	2021	2022
U.S.	2.7%	3.5%	3.4%	4.1%	3.1%	3.8%	5.0%	3.5%	-2.9%	10.8%	NA
China	13.3%	11.8%	10.5%	9.5%	2.3%	8.5%	13.0%	3.6%	0.0%	17.6%	1.8%
Germany	-5.3%	5.0%	4.8%	-16.7%	0.0%	5.3%	9.5%	-5.0%	0.0%	4.8%	3.4%
India*	14.3%	12.5%	11.1%	10.0%	9.1%	15.4%	7.1%	6.7%	0.0%	16.7%	14.8%

Country	Private Final Consumption Expenditure Contribution to GDP		
	2019	2021	2022
U.S.	67.4%	68.3%	NA
China	56%	53.9%	NA
Germany	72.2%	71.4%	73.1%
India*	60.1%	59.6%	60.5%
Japan	74.5%	75.3%	NA

Source: World Bank, RBI, Technopak Research & Analysis

* For India, CY 2012 refers to Fiscal 2013 and so on, India Data in Fiscal Year. 1US\$ = ₹ 80

3. Urbanization

Urbanization is one of the most important pillars of India's growth story as these areas are the core drivers for consumption. India had the second largest urban population in the world in absolute terms at 508 million in CY 2022, second only to China. However, only 36% of India's population is classified as urban compared to a global average of approximately 57%. It is the pace of India's urbanization that is a key trend fueling India's economic growth. Currently urban population contributes 63% of India's GDP. Going forward, it is estimated that 37% (541 million) of India's population will be living in urban centers by Fiscal 2025. This trend is expected to continue with approximately 41% and 50% of India's population expected to be living in urban centers by Fiscal 2030 and Fiscal 2050 respectively. India is the second largest urban system in the world with approximately 11% of the total global urban population living in its cities.

Exhibit 1.6: Urban Population as Percentage of Total Population of Key Economies (CY 2022)

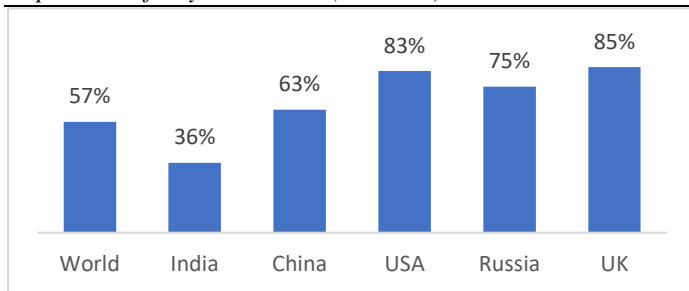

Source: World Bank

Exhibit 1.7: India's increasing Urban Population as a Percentage of Total Population over the years (CY)

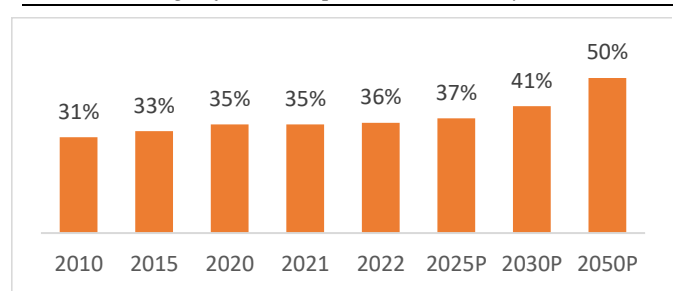

Source: Technopak Analysis

4. Growing Middle Class

Increase in number of households with annual earnings of US\$ 10,000 to US\$ 50,000 is expected to drive the Indian economy due to demand of, among other things, more goods, better services, houses, health and education. Households with an annual income between US\$ 10,000 and US\$ 50,000 formed a minority stake of 5.8% of the total population in Fiscal 2010. This share increased to 30.6% in Fiscal 2020 and is expected to continue the growth momentum and increase to 42% of the total population by Fiscal 2030. Due to the growing middle-class sector in India, there is an increasing appetite for premiumization of goods and services, construction, housing services, financial services, telecommunications and retail.

Exhibit 1.8: Household ("HH") Annual Earning Details

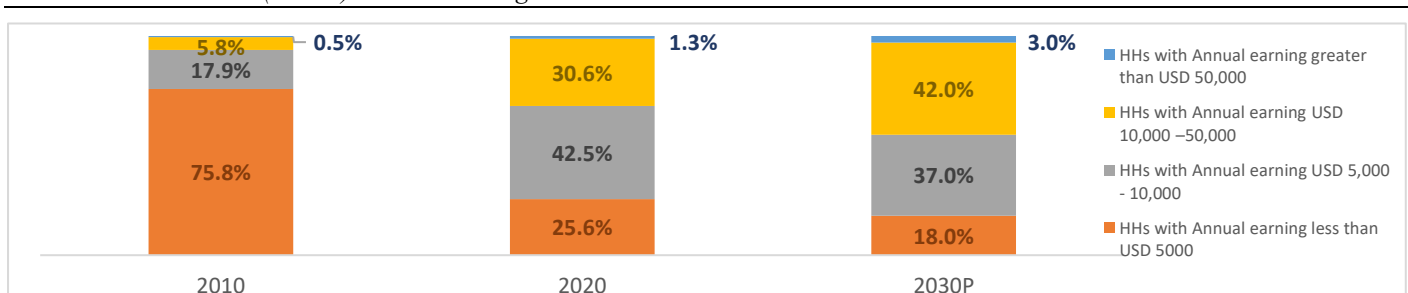

Source: EIU, Technopak Estimates

5. Nuclearization

The growth in the number of households exceeds the rate of population growth, which indicates an increase in nuclearization in India. The average household size has reduced from 5.3 in Fiscal 2001 to 4.2 in Fiscal 2021 and is further projected to reduce to 3.9 by Fiscal 2030. 69% of households had less than five members in Fiscal 2011 as compared to 62% in Fiscal 2001. Growth in the number of nuclear families is leading to an increase in the number of households, thereby creating a strong demand for housing units and discretionary expenditure in India.

6. Digitization

COVID-19 pandemic has accelerated the pace of technology adoption and digitization across enterprises and has transformed the way technology is perceived. Digitization in India is expected to grow continuously, which is expected to be driven by the affordability of accessing the internet, continuous improvement in telecommunications infrastructure, increase in consumption of

Exhibit 1.9: Total number of households in India (In million)

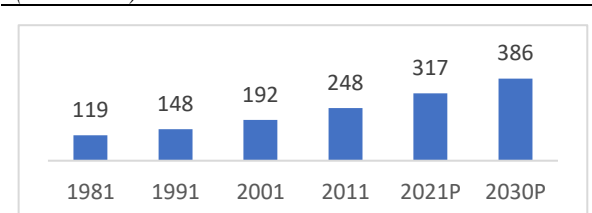

Source: Census, Technopak Analysis; Note: Decadal growth for period 2021-2030P reflects a 9-year period

data, increased adoption from Tier II and III cities, rising popularity of social media and growing trust and adoption of online payment platforms.

In this report, the following city type classification nomenclature has been considered: Metro - Delhi NCR & Mumbai, Mini Metro - Next 6 cities with population more than 5 million. (Ahmedabad, Bengaluru, Chennai, Hyderabad, Kolkata & Pune), Tier I - Cities with population between 1million & 5 million, Tier II - Cities with population between 0.3million and 1 million, Tier III - Cities with population below 0.3million.

Exhibit 1.10: Growth of digital penetration in India (Fiscal Year)

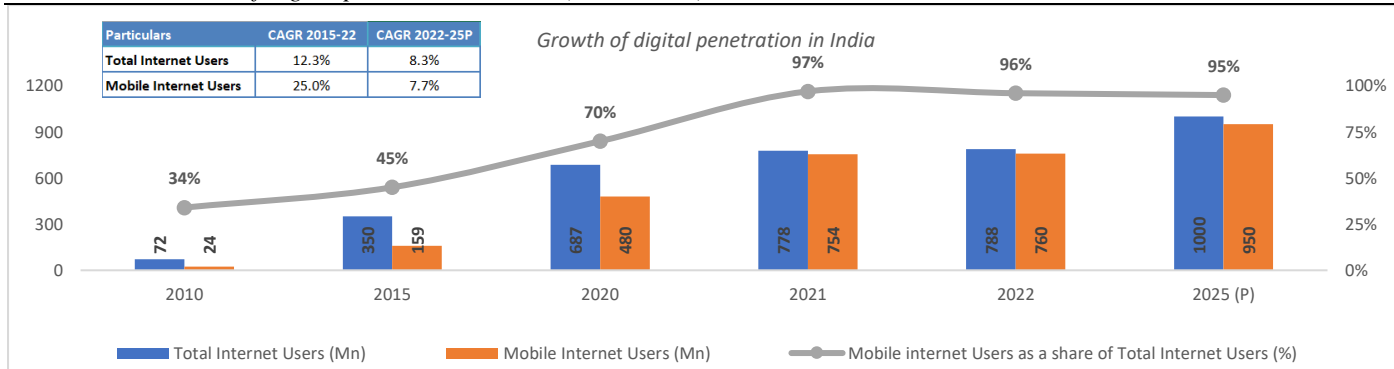

Source: TRAI, Technopak Analysis, Secondary Research

Urbanization and nuclearization is expected to increase the demand for residential real estate in India, which in turn, is expected to generate demand for electrical products as each house would require, among other things, electrical appliances, wirings, fans and lights. India’s youth and working age population, accompanied by rise in per capita income is expected to drive premiumization in fast moving electrical goods (“FMEG”) segments such as fans, lightings and home appliances. Additionally, the pace at which technology adoption and digitization is happening across India, due to factors such as improvement in telecommunications infrastructure and increase in data consumption, is expected to increase the demand for wires and cables (“W&C”) such as communication cables in India.

The Government of India (“GOI”) has announced policies aimed at boosting GDP, increasing the share of manufacturing in India and economic growth, thereby boosting electricity consumption by the industrial segment in India. GOI has also announced various schemes to revive power infrastructure, improve urban distribution networks such as Integrated Power Development Scheme (“IPDS”) and boost rural electrification. Government initiatives in housing and infrastructure sectors like Pradhan Mantri Awas Yojana (“PMAY”) and PM Gati Shakti National Master Plan (“NMP”) will likely increase the demand for electrical products in India. Construction of Multimodal logistics parks (“MMLPs”) is expected to increase the demand for wires and cables such as flexible cables, control and instrumentation cables, and construction of newly built houses is expected to drive the demand for housing wires and other FMEG products.

Section 2: Consumer Electrical Industry in India

Market Overview

India is the third largest producer and the second largest consumer of electricity in the world. Consumer electrical industry* is one of the important aspects of the Indian economy, contributing approximately 8% to the country’s manufacturing production, approximately 1.5% to India’s GDP and approximately 1.5% to India’s exports. Consumer electrical industry entails heavy electrical products such as W&C and light electrical products such as FMEG. A wire is a single conductor, whereas a cable is a group of conductors, used for, among other things, transmitting electricity and telecommunication signals. FMEG includes electrical goods and appliances such as fans, lightings, electric heaters, and other household appliances.

*Consumer electrical industry comprises of wires and cables, FMEGs, transformers, boilers etc. In this report the focus has been on wires and cables and FMEGs.

The consumer electrical industry consisting of W&C and FMEGs was estimated at approximately ₹ 1,81,150 crore in Fiscal 2023 and is expected to grow at a CAGR of approximately 10% till Fiscal 2027 to reach a market value of approximately ₹ 2,66,500 crore. The industry is highly competitive with the presence of many national and regional players (manufacturers, traders, suppliers, and importers etc.), competing on the basis of factors such as products, price, customer service, post sales services, quality and delivery. Key players in the W&C industry like RR Kabel are expanding into FMEG segment because of its high adjacency with established W&C segment. They seek to grow and strengthen their market position in FMEG market in India and abroad by leveraging their brand’s recall and existing distribution network, including electricians.

W&C primarily used for distribution and transmission of electrical power are an important constituent, representing nearly 40% of the W&C and FMEG industry in India. In Fiscal 2023, the total domestic market for W&C industry was estimated at approximately

₹ 74,800 crore, which is expected to grow at a CAGR of 13% till Fiscal 2027 to reach a market value of approximately ₹ 1,20,000 crore.

In Fiscal 2023, the total domestic market for FMEG industry was estimated at approximately ₹ 1,06,350 crore, representing approximately 59% of the total consumer electrical industry. This is expected to grow at a CAGR of 8% till Fiscal 2027 to reach a market value of approximately ₹ 1,46,500 crore.

Rural electrification, expansion in the residential and commercial real estate sector, increase in per capita consumption of electricity, Government of India's ("GoI") infrastructure development support through increased capital outlay and government funded schemes, favorable trade policies to increase exports through initiatives such as production linked incentive ("PLI") and Remission of Duties and Taxes on Exported Products ("RoDTEP") schemes, successful execution of Bureau of Energy Efficiency ("BEE") star norms and increase in demand from consumers to upgrade or replace existing products are some of the key factors, that are expected to drive the growth of the consumer electrical industry in India.

Exhibit 2.1: Indian W&C and FMEG Market – By Value (₹ in crore) in Fiscal Year

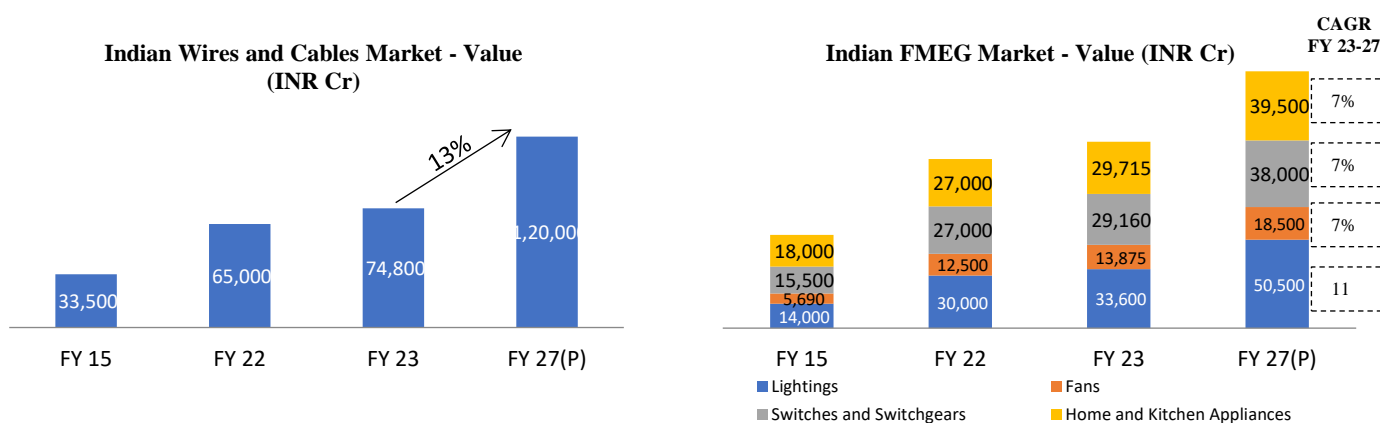

Source – Primary Research, Secondary Research and Technopak Analysis

Note: This does not include exports.

Home appliances constitute 28% and kitchen appliances constitute 72% of the Indian home and kitchen appliances market in Fiscal 2023.

Exhibit 2.2: Total Market and Branded Market of FMEG – by Value (₹ in crore) in Fiscal Year

Segment	Category	Total Market Fiscal 2023	Share of Branded Fiscal 2023	Branded market Fiscal 2023	Total Market Fiscal 2027 (P)	Share of Branded Fiscal 2027 (P)	Branded Market Fiscal 2027 (P)	CAGR of Branded Market (Fiscal 2023-2027)
W&C	Wires and Cables	74,800	72%	53,860	1,20,000	80%	96,000	16%
	Lighting	33,600	67%	22,500	50,500	75%	37,875	14%
	Fan	13,875	91%	12,630	18,500	95%	17,575	9%
FMEG	Switches and Switchgears	29,160	82%	23,900	38,000	90%	34,200	9%
	Home and Kitchen appliances	29,715	81%	24,070	39,500	85%	33,575	9%

Exhibit 2.3: Share of Branded Play in Indian W&C and FMEG market – By Value (Fiscal Year)

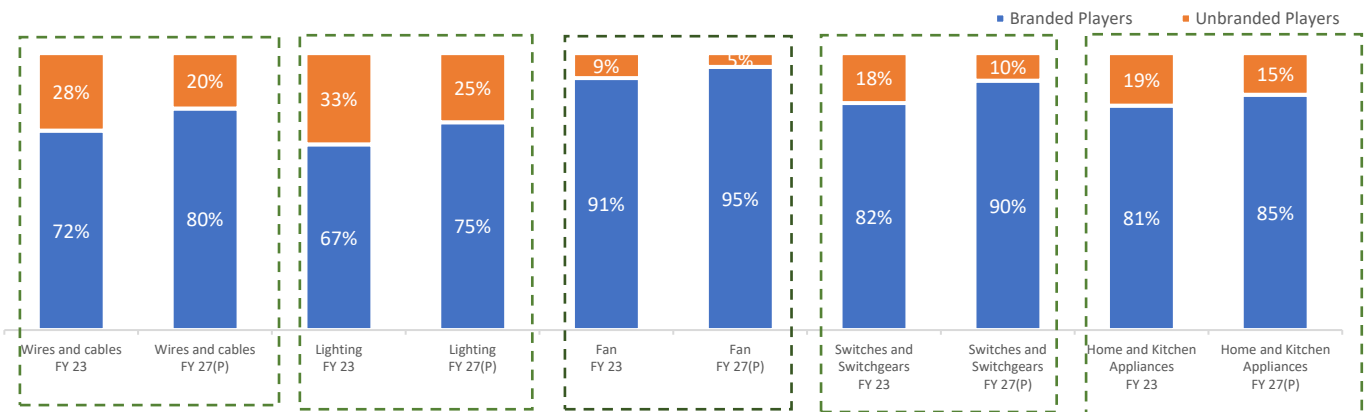

Source – Technopak Analysis

In Wires and Cables segment, the Total Addressable Market (“TAM”) for leading brands like RR Kabel, Polycab, KEI etc. is approximately ₹ 53,860 crores as of Fiscal 2023, which is projected to reach approximately ₹ 96,000 crores by Fiscal 2027. In FMEG segment, the TAM for leading brands such as Havells and Crompton Greaves and challenger brands such as RR Kabel and Polycab is approximately ₹ 83,100 crore as of Fiscal 2023, which is projected to reach approximately ₹ 1,24,000 crore by Fiscal 2027. As of Fiscal 2023, the FMEG product portfolios of leading players in W&C industry like RR Kabel covers approximately 77% of the FMEG industry market size in India by value.

Trends shaping W&C and FMEG industry in India

- **Shift towards Branded Play**

The domestic W&C and FMEG industry is pivoting towards branded play. The share of branded play in domestic W&C and FMEG industry has grown from 60% in Fiscal 2015 to approximately 76% in Fiscal 2023 and is projected to reach approximately 82% by Fiscal 2027. This consolidation of branded play is driven both by demand and supply side factors:

Demand side factors

Rising Awareness among consumers towards safety and quality: There has been a growing awareness among the consumers to seek safety and quality in electrical products. Given products’ interface involve electricity and electricals, there is a heightened consumer awareness about branded play being a proxy for trust, quality, and safety. Thus, customers across income segments have increasingly started to prefer branded products over unbranded products. This consumer behavior has led the electrical products market to get pivoted towards branded play.

Supply side factors

Goods and service tax (“GST”) Regime: With the advent of the GST regime, complete transparency of the entire go-to-market value chain (from manufacturer to retailers) has become a key imperative. This has disincentivized trade practices like under-reporting of production and sales, non-billed transactions and non-compliant behavior. Furthermore, the input tax credit for taxes paid at different stages of value chain has made trade of branded play acceptable and GST compliance has increased the input cost for unbranded players. These factors have narrowed the price gap between branded and unbranded products, consequently creating favorable market conditions for branded players to increase their share in the overall market.

Technological interventions: Continuous product improvement in W&C and FMEG industry, owing to technological interventions and innovations by branded players have made it difficult for unbranded players to compete. Innovations like Low-Smoke Zero-Halogen (“LSZH” or “LSOH”) technology in wires and cables and premiumization in FMEGs have created favorable product differentiation for the branded players in the market.

- **Premiumization**

The FMEG industry in India is witnessing increased demand for premium products as consumers are showing a rising interest towards smart, easy-to-use, and technologically advanced products. An increase in disposable income has increased the purchasing power of customers, which in turn, has accelerated the demand for premium products in India. “Smart”, “technological enablement” and “plug and play systems” are used as proxies for premiumization among FMEG products and are considered as lifestyle choices. All these factors are driving the FMEG industry towards the premium segment.

W&C and FMEG Industry – Key characteristics

1) Direct Consumer Sales Activation

Brands distribute and sell electrical products in three ways:

1. Increase in reach through distributors, dealers, and retailers
2. On site involvement of the sales team to generate leads
3. Through a brand's own stores, exclusive brand outlets (“**EBOs**”) and modern brick and mortar stores

Exhibit 2.4: Different ways of Sales Activation in W&C and FMEG Industry

Sales Channel	Sales Activation	Share (in %)
Distribution Led	Distributors and Retailers	50%-55%
Direct Company Led	Sales Team	40-45%
	Brand's exclusive stores	5%

Source – Technopak Analysis

In 1990s, 80-90% of the sale in W&C and FMEG industry was dependent on the distributors and retailers and brands had limited visibility on the distributor's sales to retailer's sales and to consumers. Currently, approximately 45% of the sale is captured by the sales team and routed to the distributors and retailers, approximately 50% of the sale is dependent on the distributors / retailers and approximately 5% sales take place through a brand's exclusive store. Companies in the consumer electrical industry have adopted an aggressive stance towards direct selling to customers on-site, including electricians, who are the key decision makers in this industry. This change in sales activation has resulted in certain benefits for companies in the consumer electrical industry such as, crowding out trade labels (which are local or regional brands), harnessing opportunistic selling behavior, de-risking the dependence on dealers and retailers, consolidating brand image through customer engagement, and providing below the line (“**BTL**”) marketing support for above-the-line (“**ATL**”) investments undertaken through building a network of influencers such as electricians. Additionally, sales through exclusive stores have increased direct consumer engagement, brand visibility and premiumization.

2) Marketing Initiatives through ATL and BTL

a) ATL focused brand building

ATL marketing remains core to building the brand in the W&C and FMEG industry. These companies use a combination of all media such as television, print, outdoor –billboards, movie theatres and digital media. Celebrity endorsements play a key role in these campaigns. Most of these campaigns are sharply focused on safety, durability, energy efficiency, design and functionality. Leading players in the consumer electrical industry like RR Kabel are spending close to 40% of its marketing investments on ATL initiatives such as celebrity endorsements, sponsoring Pro Kabaddi and IPL teams.

Exhibit 2.5: Marketing / Brand campaign themes for different electrical product categories

Product Category	Theme of Marketing / Brand Campaigns
W&C	Safety and durability
Lightings	Value economics, cost of purchase, longevity, energy saving, brightness
Fans	Energy efficiency, design and functionality, value economics
Switches and switchgears	Safety and design

b) BTL Initiatives

Various companies in the consumer electrical industry undertake BTL marketing initiatives to increase brand awareness and consumer recall of their products. BTL line activities include sales promotion, visual merchandising, direct marketing, leaflets and countertop units. Key players like RR Kabel spend approximately 60% of its marketing investments on BTL initiatives such as loyalty management program (RR Connect App) for electricians and Kabel Link (educating architects and electrical consultants about their product portfolio) to create a network of influencers such as electricians, thereby creating enhanced brand awareness and visibility.

3) Combination of In-house and Outsourcing

Within W&C and FMEG industry, players undertake a combination of in-house and outsourcing strategy. Product sourcing is done through a mix of the player manufacturing its own products, importing its products and outsourcing the manufacturing of its products to third parties. While players such as RR Kabel and KEI have backward integrated their W&C manufacturing facilities by manufacturing certain raw materials such as PVC compounds in-house so as to have better control and visibility on the quality of product, players in lightings industry rely on import of finished goods and players in the home and kitchen appliances use a combination of outsourced and in-house manufacturing.

Exhibit 2.6: In-house vs Outsourcing for different players in Consumer Electrical Industry

Category	In-house Manufacturing	Third party manufacturing	Imports	Remarks
W&C	✓✓✓	✓	✓	Largely manufactured in-house with limited third-party manufacturing and imports
Lightings	✓	✓	✓✓✓	Components are imported from China / Korea, followed by assembly of the product by the brand or vendors in India
Switches and switchgears	✓	✓✓		In-house manufacturing with vendor relationship within India
Fans	✓✓	✓	✓	Largely manufactured in house with some third-party manufacturing (“OEMs”) and limited imports
Home and kitchen appliances	✓✓	✓✓	✓✓	Combination of in-house and third-party manufacturing and imports.

Source – Secondary research, Technopak Analysis, ✓✓✓- High presence, ✓✓-Medium presence, ✓- Low presence

Exhibit 2.7: Estimated In-house vs outsourcing share for different players in Consumer Electrical Industry (Fiscal 2023)

Companies	In-house Manufacturing (%)	Outsourced (%)
RR Kabel	93%	7%
Havells	90%+	<10%
Polycab	95%	5%
KEI	95%	5%
Finolex	97%	3%
V-Guard	45%	55%
Crompton	NA	NA
Bajaj Electricals	NA	NA

Source – Annual Reports, Secondary research, and Technopak Analysis, NA-Not Available

Key Growth Drivers of Consumer Electrical Industry in India

There are six key factors supported by a positive macro environment that are expected to provide growth in the W&C and FMEG industry between Fiscals 2022 and 2032:

1. Public and private investment outlay in infrastructure
2. Continued growth of residential real estate sector
3. Resilient commercial real estate sector
4. Transition of automobiles and transport towards electric vehicles (“EVs”)
5. Rural electrification
6. Push towards renewable energy

1. Public and private investment outlay in infrastructure

Various policy interventions have been undertaken by GoI in the infrastructure sector to boost India’s GDP and economic growth. These initiatives intend to drive the growth of W&C and FMEG industry in India.

- **National Infrastructure Pipeline (“NIP”)**: GoI has announced an outlay of approximately ₹ 111 lakh crore in the infrastructure sector between Fiscal 2020 and Fiscal 2025 to help make India a US\$ 5 trillion economy by Fiscal 2026. For Fiscal 2024, the projected infrastructure investments under NIP are around ₹ 15.4 lakh crore.
- **Capex by GoI**: Capital investment of approximately ₹ 10 lakh crore on infrastructure sector (approximately 3.3% of GDP) has been announced by GoI in the Indian union budget 2023-24. Additionally, a capital outlay of ₹ 2.4 lakh crore has been provided for railways. The principal areas identified for capital expenditures include roads, railways and metros, which require high supplies of W&C and FMEG products. With the expansion of transport infrastructure, Technopak expects there to be a corresponding increase in demand for electrical goods such as W&C, lighting and switchgears, thereby creating a market opportunity for W&C and FMEG manufacturers.
- **PMAY**: The GoI under the ‘Housing for All’ scheme, has aimed to build approximately 12 million houses for urban and approximately 28.5 million house in the rural parts of India.

Under PMAY (Urban), the total capital assistance committed by GoI to build approximately 12 million units of houses was approximately ₹ 2.02 lakh crore, of which approximately 7.4 million units of houses have been completed by releasing ₹ 1.14 lakh crore till April 2023 and the remaining approximately 4.6 million units of houses are expected to be completed by CY 2024. Under PMAY (Gramin), the total capital assistance transferred, or fund utilized by the government till April 2023 to build approximately 28.5 million units of houses is approximately ₹ 2.98 lakh crore, of which approximately 22.2 million units of houses have been completed and the remaining approximately 6.3 million units are expected to be completed by CY 2024.

Approximately 11 lakh houses (approximately 4.6 lakh houses in urban and approximately 6.3 lakh houses in rural) are under construction or to be constructed in coming years under the PMAY by CY 2024. Further, the budget outlay for PMAY has been increased by 66% to over ₹ 79,000 crore, as per the Indian union budget 2023-24.

Exhibit 2.8: Supply of Housing under Government Schemes (PMAY – Urban and PMAY – Rural) (in millions)

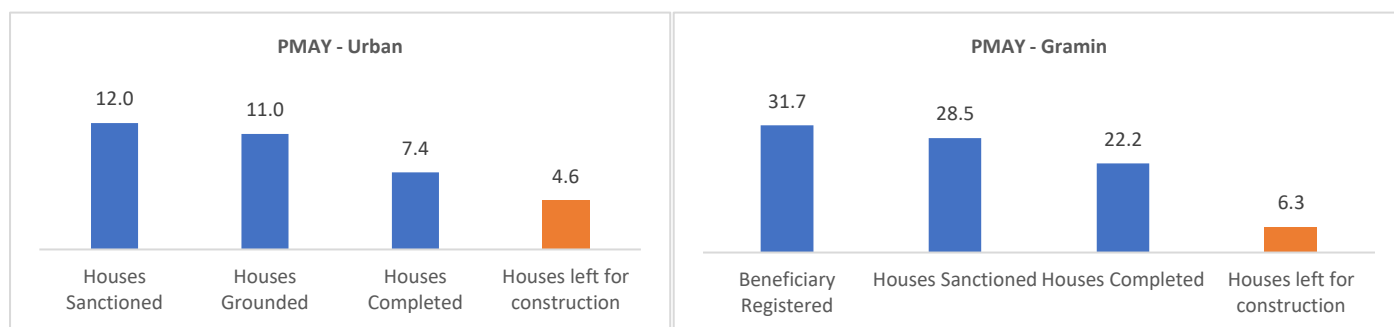

Source: PMAY

Note: All units in the above chart are in millions

These initiatives are expected to generate demand for W&C such as housing wires, power cables, flexible and specialty cables and for FMEG products like lights, fans, home, and kitchen appliances in the next 5-7 years.

- **Urbanization and Smart Cities**

In the last decade, the urban population in India has grown at an annual rate of 2.4%. The urban population of India is projected to reach approximately 41% by CY 2030 from 31% in CY 2010. Further, the number of metropolitan cities in India are estimated to increase from 46 as per Census 2011 to 68 in CY 2030. Additionally, Smart City project was launched in June 2015 by GoI with a plan to build 100 smart cities across India, having an objective to promote cities that provide core infrastructure, good quality of life to its citizens, a clean and sustainable environment with application of ‘Smart’ solutions. As on December 2, 2022, GOI has released approximately ₹ 34,675 crore as part of Smart City project, of which approximately ₹ 30,418 crore (88%) have been utilized in building smart cities across India. These initiatives are expected to generate demand for electrical products especially in the W&C, switches and switch gear segments in next 5-7 years.

- **Foreign Direct Investment (“FDI”) and private equity (“PE”) investment in real estate sector**

In the past decade and a half, GoI has liberalized the FDI regulations, which has resulted in an increase of foreign investments and economic expansion in the real estate sector. India has an optimistic growth prospect for FDI with a potential to attract FDI flow of US\$ 475 billion in the next five years.

Post implementation of Real Estate Regulatory Authority (RERA) Act and increase in transparency and returns, there has been a surge in private investment in the real estate sector. FDI in the sector (including construction development and activities) stood at US\$ 55.2 billion from April 2000 to September 2022. In India, Bengaluru is believed to be the most preferred property investment destination for non-resident Indians (“NRIs”), followed by Ahmedabad, Pune, Chennai, Goa, Delhi, and Dehradun.

The investments dropped 17% Y-o-Y in CY 2022 due to inflation risk, rising interest rates, and geopolitical instability. PE investments of US\$ 5.1 billion were received in CY 2022.

Exhibit 2.9: PE investment in Indian real estate over the years (in US\$ billion) (CY)

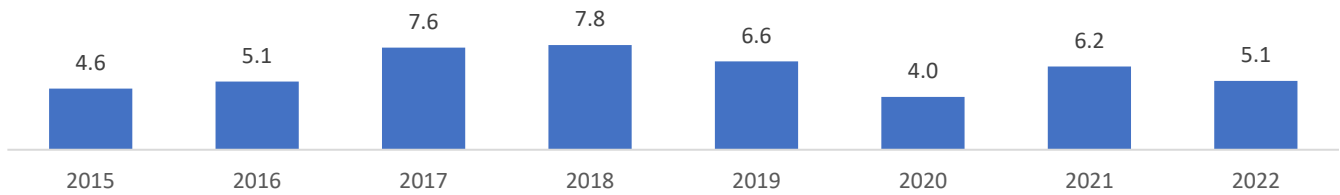

Source: Technopak Analysis and Secondary Research

With the rise in private investments and FDI inflow in India, Technopak expects there to be a surge in demand of the real estate sector in both the rural and urban areas. Sectors like W&C are expected to experience a boost, as there will be growing need for transmission and distribution lines to supply electricity. Further, with an increase in the number of residential, commercial, and retail units, FMEG products such as fans and lights are expected to see a surge in their demand.

- **Policy Reforms**

Various policy reforms have been incorporated by GoI to boost production, exports and promote ease of doing business. Such interventions are going to boost the demand for wires and cables and FMEG products in India.

- **PLI Scheme:** Under PLI scheme, GoI aims to have large-scale electronics manufacturing in India. ₹ 1.97 lakh crore have been allocated for PLI in Indian union budget 2020-21 for next 5 years, which is expected to boost production by over \$500 billion by FY 26. There is a PLI Scheme specifically for white goods (air conditioners and light emitting diode (“LED”) lights) manufacturers in India under which, GoI proposes a financial incentive to boost domestic manufacturing and attract large investments in white goods manufacturing value chain, with an objective of removing sectoral disabilities, creating economies of scale, enhancing exports, creating a robust component ecosystem and employment generation. This scheme is expected to be implemented over Fiscal 2022 to Fiscal 2029 with a budgetary outlay of ₹ 6,238 crore. A total of 57 firms with committed investment of approximately ₹ 6,000 crore have been provisionally selected as beneficiaries under this scheme.
- **Integrated Power Development Scheme (“IPDS”):** IPDS envisages strengthening of sub-transmission and distribution network including metering at all levels in urban area. Till March 2023, projects worth ₹ 31,314 crore have been sanctioned under IPDS, against which, ₹ 15,922 crore have been released towards projects and ₹ 219 crore released for enabling activities.
- **Export reforms:** Various conducive export policies have been announced by GoI. For example, RoDTEP scheme has been introduced which provides rebates to various central, state, and local duties/ taxes on exported products. Advance Authorization Scheme (“AAS”) and the Export Promotion Capital Goods (“EPCG”) Scheme are being implemented to enable duty free import of raw materials and capital goods for export production.
- **GST Regime:** With the introduction of GST regime, there have been many structural changes to the business scenario such as elimination of cascading tax effect, fewer compliances, simple and online procedure and regulation of unbranded players.
- **Digitalization**

Digitalization is transforming the way businesses work. There has been increased adoption of digital technologies in workplaces. Additionally, various initiatives have been launched by GoI to boost digital infrastructure such as Digital India and Bharatnet, leading to higher demand for internet connectivity and for new age technologies such as 5G. These trends are going to play a significant role in the growth of electrical industry.

- **Bharatnet:** It is one of the biggest rural telecom projects in the world, implemented in a phased manner to all Gram Panchayats (“GPs”) (approximately 2.5 lakh) in India for providing non-discriminatory access to broadband connectivity to all the telecom service providers. As of June 2021, length of optical fiber cable (“OFC”) laid was 5,24,686 kms and number of GPs where OFC laid was 1,72,941.
- **Digital India:** GoI has launched the Digital India program with the vision of transforming India into a digitally empowered society and a knowledge-based economy, by ensuring digital access, digital inclusion, digital empowerment and bridging the digital divide. Some of the key initiatives under this program are Common Services Centers (“CSCs”) and Digital Village. Till March 2023, 5.2 lakh CSCs, offering over 400 digital services, are functional across India (including urban and rural areas), out of which, 4.1 lakh CSCs are functional at GP level. Approximately 700 GPs / village with at least one GP / village per District per Indian state / union territory (“UT”) are being covered in the Digital Village Pilot Project

started in October 2018 by Ministry of Electronics and Information Technology, GoI, where concerned villages would be provided digital services such as digital health services, education services and financial services.

- **New age sectors**

- Emergence of new age sectors like the construction of Multimodal logistics parks (MMLPs) as a part of the Gati Shakti National Master Plan, local data centers and airports (airport cables would be required for passenger terminals, escalators etc.) is expected to drive the increase in demand of wires and cables such as flexible cables, control and instrumentation cables etc. and FMEG products in India.

- **Safety and Energy Efficiency Standards**

In order to promote the use of energy efficient products, BEE has introduced voluntary and mandatory star labelling norms for certain electrical product categories. For example, voluntary star labelling program was introduced for ceiling fans in CY 2019, which has been mandated in CY 2023. Introduction of safety standards are also accelerating the shift towards branded play.

2. ***Continued growth of residential real estate sector***

Every newly built residential unit implies not only increased demand for W&C and FMEG products like light, fans and switches, but also creates an installed base for replacement demand for these products.

The demand for residential real estate in India depends on various factors such as population growth, economic conditions, and lifestyle changes. With the rise in population and urbanization, the demand for houses is likely to increase. India is expected to witness the growth in residential real estate market driven by both, the private sector led residential real estate and of government led aimed at affordable housing (PMAY and others).

With the increase in demand for the residential space in both affordable and premium segments, India’s residential market has witnessed a rapid growth in recent years. Residential sales volume across the major cities in India witnessed a 51% annual rise from approximately 2.4 lakhs units sold in CY 2021 to approximately 3.7 lakhs unit sold in CY 2022 signifying a healthy recovery in the sector, post COVID-19 pandemic. The top 7 Indian cities with the highest residential unit sales in CY 2022 are Mumbai, National Capital Region (NCR), Bengaluru, Pune, Chennai, Hyderabad, and Kolkata.

Exhibit 2.10: Supply of Residential House in top 7 cities of India (in Lakhs) (CY)

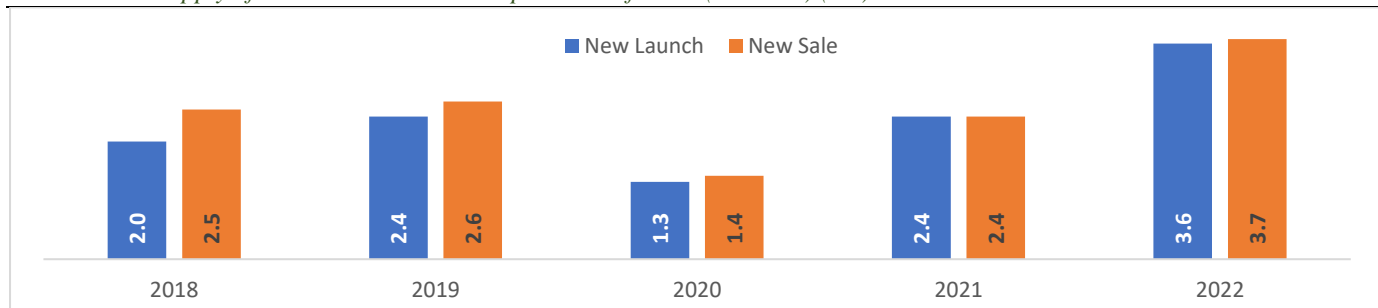

Source: Secondary Research

The GoI has implemented various reforms in the real estate sector to improve transparency, affordability, and accessibility of housing such as RERA and affordable housing policies which has significantly increased the confidence of the home buyers and investors. Further, the introduction of GST has simplified the tax structure for the real estate sector, reducing the overall tax burden on home buyers. There are many more such housing board schemes being run by Indian state governments. These combined efforts of both the central and state governments to facilitate a greater number of residential houses is expected to continuously create and increase demand for W&C and FMEG products in the coming years.

3. ***Resilient commercial real estate sector***

The commercial property market is estimated to expand at a CAGR of almost 13% from the projected period of the CY 2022 to CY 2027. The commercial real estate sector mainly comprises of office space, retail space, data center space in both owned and leased premises.

Office space

Office spaces are a strong demand support for the consumer electrical industry, largely defined as institutional demand for various products offered by the consumer electrical industry. The incremental supply of office spaces that is projected to unfold in India in the next decade, therefore provides a strong support for the consumer electrical industry. Indian office market witnessed new supply

of 42.6 million sq. ft. in CY 2021, out of which 26.2 million sq. ft. area was absorbed. In CY 2022, the new supply was estimated at 50-52 million sq. ft. out of which 30.3 million sq. ft. was absorbed during period January 2022 to September 2022 and is projected to offer a new supply of around 53-54 million sq. ft. in CY 2023.

Exhibit 2.11: India Market for Office Space (in million sq. ft.) in CY

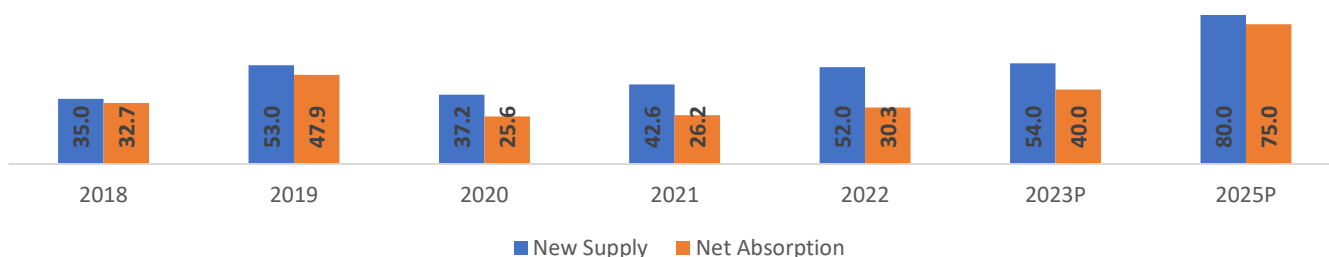

Source: Secondary Research
 Indian office space market figure in Fiscal 2022 is till September 2022

Service economy and co-working spaces are two key demand drivers for the office supply in India. The size of the service economy in India and its resilient growth outlook in future is expected to provide a strong base for the continued growth of office spaces in the next decade. The growth of services exports (such as IT and information technology enabled services (“ITES”) sector) of India serves as a good proxy for the same and was estimated at US\$ 250 billion in Fiscal 2022 and this grew from US\$ 206.09 billion in Fiscal 2021 at a growth rate of 21.3%. India’s size of service exports is expected to grow to US\$ 800-1,000 billion by Fiscal 2030 at a CAGR of 11-12%.

Managed office spaces / co-working sector has also gained popularity and is predicted to grow by more than 15% over the next three years. The co-working space segment’s share in total absorption has increased from 12% in CY 2019 to nearly 13% in CY 2022. The sector witnessed a yearly growth of 30% from CY 2021 to CY 2022, as compared to a negative growth observed during the time of COVID-19 pandemic.

Retail space

Retail shops, either as standalone units or as part of a controlled space such as malls or mixed used buildings represent the second driver of commercial real estate. India’s consumption basket for overall retail market in the year CY 2022 was US\$ 844 billion and is expected to reach US\$ 1,162 billion by CY 2025. Of this, traditional share of retail is expected to be approximately 80% and the share of brick led modern retail is expected to be approximately 11% by CY 2025. The share of e-commerce was approximately 6% in CY 2022 and is expected to reach approximately 9% by CY 2025.

While, e-commerce has witnessed outsized growth over brick retail in the last decade, it has been from a low base. Further, the brick retail, both in traditional and modern brick form, has stayed resilient during this period. The growth of malls and brick and mortar modern retail during CY 2015 to CY 2022 demonstrates this point. In the next decade, India’s retail industry is expected to shift towards digital retail, while still maintaining the important role of physical brick-and-mortar stores.

Data centers

India’s growing data-consumption has spurred the need to store and process data, thus increasing the demand for data centers in India. The connectivity provided by the wiring and cabling infrastructure is the foundation of every data center to power them and keep pace with their processing speed and efficiency. Every new supply of data center as well as already installed base is expected to create demand for wires and switch gears not only in the new installation but also for replacement purposes, thereby, driving the demand for the W&C and FMEG sector.

The Indian IT ministry plans to offer incentives worth up to ₹ 15,000 crore under a national policy framework for data centers. The GoI is eyeing an investment of up to ₹ 3 lakh crore in the data center ecosystem over the next five years. This is expected to further accelerate the data center expansion in India. Therefore, the data center market is expected to grow at a CAGR of approximately 15% during CY 2022 to CY 2027.

As of March 2022, the number of data centers in India were 138 with 11 million sq. ft. area and is projected to reach 183 by CY 2025, comprising approximately 24 million sq. ft. area. The data center industry in India was valued at US\$ 400 million in CY 2014, which has grown to US\$ 4.4 billion in CY 2021 and is projected to reach US\$ 10.1 billion by CY 2027, growing at a CAGR of approximately 15% between CY 2022 and CY 2027. Data center capacity is expected to exceed 1.7 GW levels by CY 2025 from approximately 900 MW in CY 2022.

Exhibit 2.12: Data Center market in India (CY)

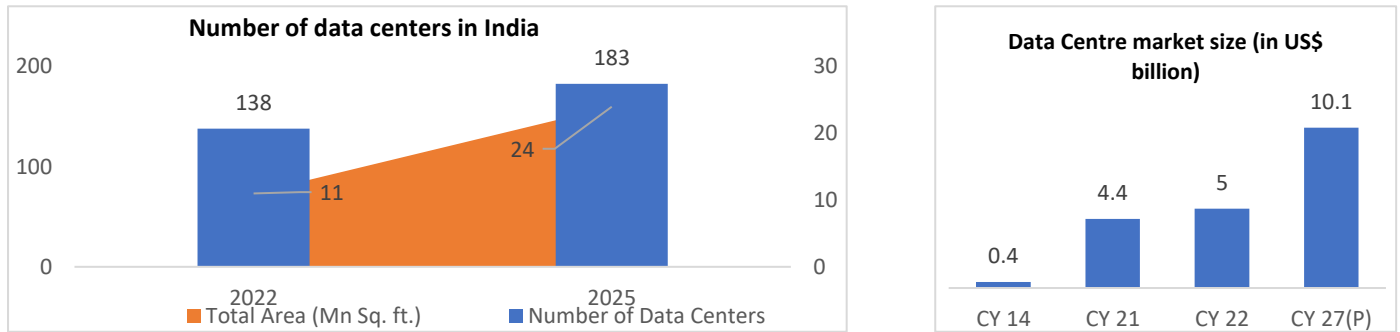

Source: Secondary Research

4. Transition of automobiles and transport towards EVs

EVs use electricity to charge their batteries which requires proper setup of wiring cables and switches to ease the process of plug-in/out at the charging stations or at home. With the increase in transition of automobiles and transports towards EVs, there is an increased demand for supply of charging stations, thus enabling the supply of more electrical products. Therefore, it is an important demand driver for the W&C industry.

The GoI has a target to achieve 30% electrification of the India’s vehicle fleet by CY 2030 and has introduced several incentives and policies to support the growth of the EV industry. The EV sales are estimated to grow four times by CY 2025 and go up further to over 10 million units by CY 2030.

It is estimated that the India's domestic electric vehicle market will see a 47% CAGR between CY 2022 and CY 2030, with 10 million annual sales by CY 2030. Further, the EV market in India is expected to grow from US\$ 3.2 billion in CY 2022 to approximately 110 billion in CY 2029.

Exhibit 2.13: EV units sold in India (numbers in ‘000) (CY)

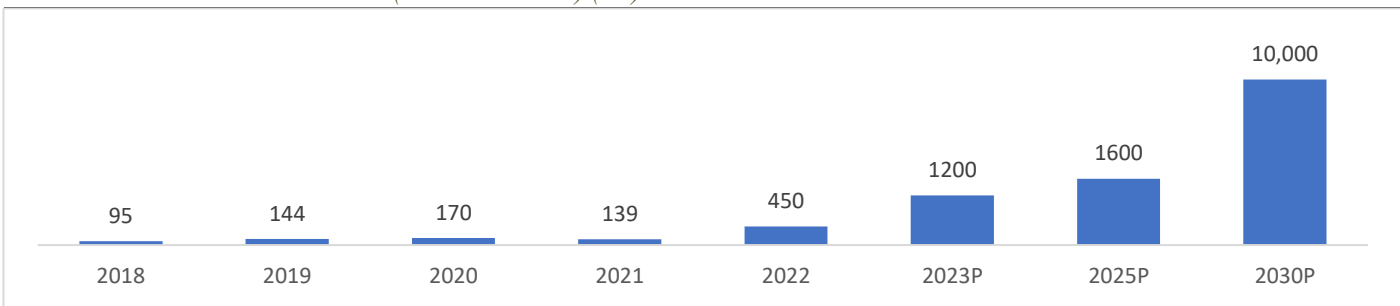

Source: Society of Manufacturers of Electric Vehicles

Key policy initiatives – growth levers for EV in India

The GoI has always been at the forefront of framing policies related to EV adoption in India. The government initiatives launched to increase EV adoption are provided below:

- **Faster adoption and manufacturing of (Hybrid and) EVs (“FAME”) India Scheme:** FAME India was launched in CY 2015 which aimed to promote growth and early adoption of hybrid and EVs in India. FAME-II scheme was launched having a budget outlay of US\$ 1.3 billion (₹ 10,000 crore) to support over 1 million e-two-wheelers, 0.5 million e-three-wheelers, 55,000 e-passenger vehicles and 7,000 e-buses across the country. GoI has extended the scheme until CY 2024, as announced in the Indian union budget 2022-23.
- **PLI Scheme** launched by GoI for advanced chemistry cell battery storage to boost India’s battery manufacturing. According to a Niti Aayog estimate, India's battery storage capacity is expected to reach 600 gigawatt hours (“GWh”) by CY 2030.
- **Battery Swapping Policy:** During the Indian union budget 2022-23, GoI announced plans to introduce a Battery Swapping Policy and interoperability standards, with the intent of building and improving the efficiency of the battery swapping ecosystem, thereby driving EV adoption.

• **Other Initiatives by the Indian government:**

- Tax exemption of up to ₹ 1,50,000 (US\$ 1,960) under section 80EEB of Income Tax Act, 1961 while purchasing an EV (2W or 4W) on loan.
- Reduction of customs duty on nickel ore (key component of lithium-ion battery) from 5% to 0%.
- The GST on electric car sales has been cut from 12% to 5%.

Further, in the e-commerce and logistics sector, few companies such as Flipkart and Zomato have pledged 100% transition to EVs by CY 2030 by electrifying their delivery fleets in order to reduce their overall carbon footprint.

EV Infrastructure

The EV push in India has opened up business opportunities across three key segments – mobility, infrastructure (W&C) and energy. These include opportunities in EV franchising, EV OEM market, battery infrastructure, solar vehicle charging and battery swapping technology, among several others. With the expansion of the EV infrastructure, the industry of W&C and FMEG products is expected to witness a surge in demand. Basis the increasing sales of EVs in the market, India is expected to require installation of 20.5 lakhs charging infrastructure by CY 2030.

Exhibit 2.14: EV charging Infrastructure in India (numbers in lakhs) (CY)

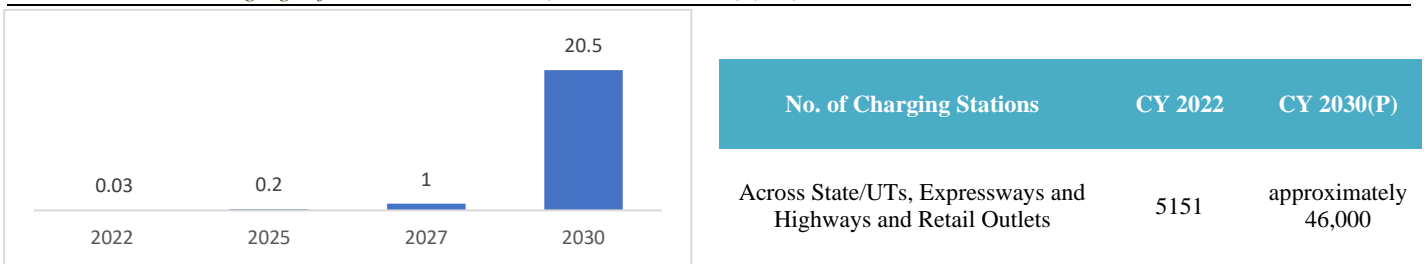

Source: Secondary Research

5. Rural Electrification

The betterment of road connectivity of villages and rural areas with the towns and cities has improved the standard of living of rural households. With this, the demand for basic electricity needs has also grown over time in rural areas, thus increasing the demand of new supply of electrical goods.

The Deendayal Upadhyaya Gram Jyoti Yojana (“**DDUGJY**”) introduced by GoI was launched on December 3, 2014, with an objective to provide electricity supply to rural India and electrify the non-electrified villages in India. Further, the Pradhan Mantri Sahaj Bijli Har Ghar Yojana – Saubhagya (“**Saubhagya**”) was launched in October 2017 by GoI for electrification of rural and urban poor households in India.

As per the report by Ministry of Power, GoI, a total 2.9 crore households have been electrified till March 2023 out of which seven states namely, Assam, Chhattisgarh, Jharkhand, Karnataka, Manipur, Rajasthan, and Uttar Pradesh reported 100% household electrification as on March 31, 2021. More than 11.8 lakh households still remain to be electrified, which is expected to be completed over the next few years.

The number of electrified villages has increased from 3000 villages in CY 1950 to 6 lakhs village in CY 2022.

Exhibit 2.15: Number of villages electrified in India (CY)

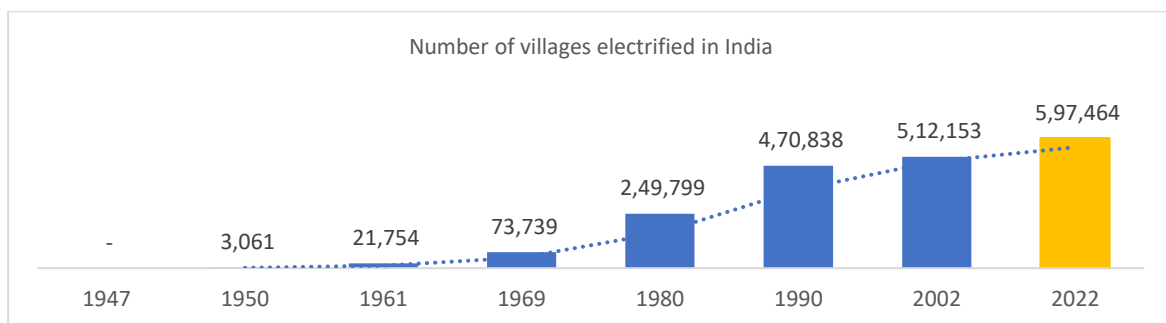

Source: PIB

Electrification in India has increased over time with the support from schemes like DDUGJY, Saubhagya and IPDS, which has given the electrical market a major boost. It has opened new markets for companies in the W&C and FMEG industry, that can now sell their products into the rural parts of India as well. The expansion of rural electrification is expected to significantly increase the demand of electrical products, as new power lines and infrastructure need to be set up and maintained.

6. Push towards Renewable Energy

As a part of Paris Agreement Under the United Nations Framework Convention on Climate Change, many countries have committed to hold the increase in the global average temperature to well below 2°C above pre-industrial levels. Japan, South Korea, and European Union have announced net zero emissions by CY 2050. India has also announced to achieve net zero emission by CY 2070. Such commitments of different nations towards building a cleaner, greener, and sustainable environment have resulted in increased adoption of renewable energy projects such as solar and wind energy, which in turn is expected to serve as a key growth driver for W&C and FMEG industry in India as well as global market. India is planning to install 500 GW of renewable energy capacity by CY 2030, which is expected to involve an investment of at least ₹ 2.4 lakh crore.

India’s energy demand is expected to increase more than that of any other country in the coming decades due to its sheer size and enormous potential for growth and development. India’s renewable energy capacity reached at 168.96 GW by February 2023, and it is expected to achieve 500 GW of installed renewable energy capacity by 2030, out of which 280 GW is expected from solar energy.

India has installed capacity of around 62 GW of solar power plants as on November 30, 2022, of the total target installation of 100 GW grid-connected solar power plants for the National Solar Mission (“NSM”) launched in January 2010 by GoI. This includes 52 GW from ground-mounted solar projects, 7.8 GW from rooftop solar projects, and 2.1 GW from off-grid solar projects. Further, new developments in solar projects are being approved in different states to generate electricity that is scaling up the demand for electrical goods to connect long distant grids with each other.

To facilitate large scale grid-connected solar power projects, a scheme for “Development of Solar Parks and Ultra Mega Solar Power Projects” is under implementation with a target capacity of 40 GW capacity by March 2024.

Exhibit 2.16: Solar energy capacity forecast (Fiscal year)

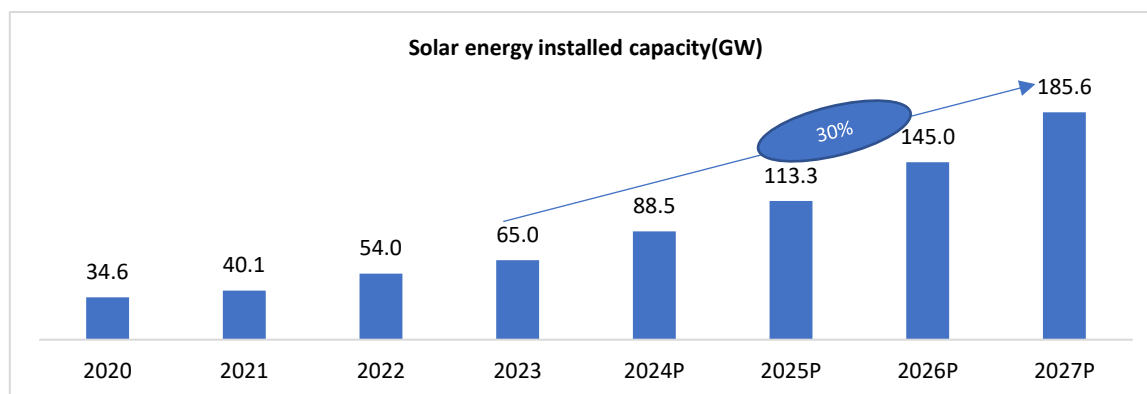

Source: Secondary Research

Solar power capacity has increased by 15x times between Fiscal 2014 and 2021, i.e., from 2.6 GW in Fiscal 2014 to 40.1 GW in Fiscal 2021 and is further expected to grow at the rate of approximately 2.9x between Fiscal 2023 and Fiscal 2027.

During the Indian union budget 2022-23 speech, an additional allocation of ₹ 19,500 crore was announced to augment solar PV module manufacturing under the PLI scheme.

Impact of key growth drivers on the W&C and FMEG industry

The table below depicts the impact of the key growth drives on W&C and FMEG sector.

Sl. No.	Key Growth Drivers of W&C and FMEG industry	W&C	Lights	Fans	Switches and Switch gear
1	Public and private investment outlay in infrastructure	High	Medium	Medium	Medium
2	Urbanization and smart cities	High	Medium	Medium	Medium
3	FDI and PE investment in real estate sector	High	High	High	High
4	Continued growth of residential real estate sector	High	High	High	High

5	Resilient commercial real estate sector	High	High	High	High
6	Transition of automobiles and transport towards electric vehicles	High	NA	NA	NA
7	Policy reforms promoting production, exports and ease of doing business	High	Medium	Medium	Medium
8	Digitalization	High	NA	NA	NA
9	Safety standards	High	High	High	High
10	Rural electrification	High	Medium	Medium	Medium
11	Push towards renewable energy	High	NA	NA	NA

Section 3: Wires and Cables Market in India

Industry Overview

- Wires and Cables Market Size**

The W&C market constitutes approximately 41% of the Indian W&C and FMEG industry. It has grown at a CAGR of approximately 11% from ₹ 33,500 crore in Fiscal 2015 to ₹ 74,800 crore in Fiscal 2023 and is further expected to grow at a CAGR of approximately 13% till Fiscal 2027 to reach a market value of ₹ 1,20,000 crore.

Exhibit 3.1: Indian Wires and Cables Market – By Value (₹ Cr) in Fiscal Year

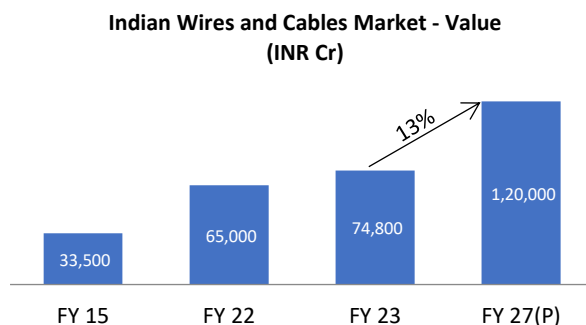

Source – Technopak Analysis
Note: This does not include exports.

- Key sub-categories of Wires and Cables**

A wire is a single conductor, whereas a cable is a group of conductors, used for transmitting electricity and telecommunication signals.

W&C market can be divided into 5 key sub-categories namely housing wires, power cables, control and instrumentation cables, communication cables and flexible and specialty cables.

- Housing wires** are used in the construction of almost every commercial, industrial, and residential property and these products carry electrical current to all power applications in a building.
- Power cables** are mainly used for power transmission and distribution purposes.
- Control and instrumentation cables** are multiple conductor cables that convey low energy electrical signals used for monitoring or controlling electrical power systems and their associated processes.
- Communication cables** are electrical cables used to send information signals and are most commonly found as coaxial, fiber optic, data and ethernet, and twisted wire pairs.
- Flexible cables** are used in, among other things, consumer appliances, railways and mining and **specialty cables** are used for marine, oil and gas facilities offshore / onshore.

Housing wires constitute approximately 32.8% (₹ 24,535 crore) of the wires and cables market in India. In Fiscal 2023, The market size of 90m, 180m and 200m housing wires by value are ₹ 14,530 crore, ₹ 45 crore and ₹ 9,960 crore respectively. State wise market size of 90 m, 180m and 200m housing wires by value are given in exhibit 3.2 below.

Exhibit 3.2: Indian Housing Wires and Cables State wise Market – By Value (₹ Cr) in Fiscal Year

State	Domestic Market Size of 90m Housing Wire in Fiscal 2021	Domestic Market Size of 200m Housing Wire in Fiscal 2021	Domestic Market Size of 90m Housing Wire in Fiscal 2022	Domestic Market Size of 200m Housing Wire in Fiscal 2022	Domestic Market Size of 90m Housing Wire in Fiscal 2023	Domestic Market Size of 180m Housing Wire in Fiscal 2023	Domestic Market Size of 200m Housing Wire in Fiscal 2023	Domestic Market Size of 90m Housing Wire in Fiscal 2024 (Apr–Jun 3M)	Domestic Market Size of 180m Housing Wire in Fiscal 2024 (Apr–Jun 3M)	Domestic Market Size of 200m Housing Wire in Fiscal 2024 (Apr–Jun 3M)
Andhra Pradesh	570	380	665	505	245	0	390	55	0.2	70





Assam	430	285	500	380	120	0	155	30	1.1	40
Bihar	635	425	740	560	275	0	175	60	1.1	25
Chhattisgarh	170	110	195	150	215	0	275	45	0.2	80
Delhi NCR	430	285	500	380	655	0	675	120	8.1	190
Gujarat	820	545	950	725	1,685	0.2	1,650	445	0.4	310
Haryana	385	255	450	340	630	0	235	105	2.9	45
Jharkhand	280	190	325	250	125	0	65	30	0.0	5
Karnataka	630	420	730	555	250	0	315	50	0.0	50
Kerala	585	390	680	520	1,840	0	430	235	0.0	90
Madhya Pradesh	440	295	510	390	640	0	680	170	3.9	185
Maharashtra	1,235	825	1,430	1,085	2,835	0	1,665	555	13	330
Odisha	225	150	260	200	230	0	135	50	0.7	25
Punjab	320	215	370	280	735	21	400	145	14.4	75
Rajasthan	375	250	440	330	895	3.2	850	190	8.0	170
Tamil Nadu	665	445	780	590	1,230	18	565	270	13.2	115
Telangana	595	395	690	525	195	2.5	515	35	3.8	150
Uttar Pradesh	915	610	1,050	800	1,265	0	445	255	21.7	80
Uttarakhand	75	50	85	65	30	0	35	10	0.8	5
West Bengal	645	430	750	570	435	0	305	100	1.9	85

Source – Technopak Analysis

RR Kabel is one of the leading consumer electrical companies in the housing wire segment in India, representing approximately 10.4% market share by value in the domestic housing wire market in Fiscal 2023. They have been able to do so through certain initiatives such as ‘Project KaRRma’ in Fiscal 2020 (comprising of two phases to double the market share and retail outreach in domestic house wires, before increasing micro and nano market* reach), to achieve a higher market share in housing wires by expanding retail outlets, electricians, sales force and product portfolio. The other key player in the housing wire segment is Finolex, while Polycab and KEI dominate the power cables segment.

*Micro markets are the individual pin codes in urban towns (all towns with over 0.3 million population) and Nano markets are particular localities within the pin code.

Exhibit 3.3: Sub-categories of Wires and Cables with examples

Sub-category of Wires & Cables	Sectors in which pre-dominantly used	Examples
Housing Wires	<ul style="list-style-type: none"> Wiring of residential and commercial buildings such as apartments, shopping complexes and offices. 	
Power Cables	<ul style="list-style-type: none"> Power transmission and distribution Solar and wind energy 	
Control and instrumentation cables	<ul style="list-style-type: none"> Chemical and fertilizers Automotive Steel Oil and gas 	
Communication cables	<ul style="list-style-type: none"> Service sector Industrial sector such as steel, automotive etc. Residential buildings for internet, intercom purpose 	

- Flexible and specialty cables
- Consumer appliances
 - Railways
 - Mining
 - Marine, oil and gas facilities offshore / onshore



Source – Secondary research

Exhibit 3.4: Break up of different sub-categories of W&C Industry in India -By Value (Fiscal Year)

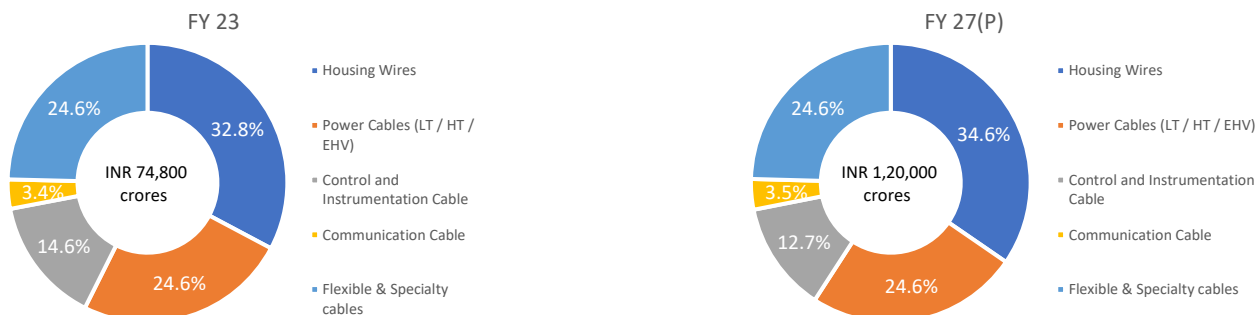

Source – Technopak Analysis

Exhibit 3.5: Sub-category wise CAGR of W&C between Fiscal 2023 and Fiscal 2027(P)

Sub-category of Wires & Cables	CAGR between Fiscal 2023 and Fiscal 2027(P)
Housing Wires	14.1%
Power Cables	12.5%
Control and instrumentation cables	8.7%
Communication cables	13.4%
Flexible and specialty cables	12.5%

Source – Technopak Analysis

Trends shaping the Domestic Wires and Cables Market

- **Shift towards Branded Play**

As of Fiscal 2023, branded players have nearly 72% of the market share (approximately ₹ 53,860 crore) of the W&C market in India. Within this 72%, five leading players namely Polycab, KEI, Havells, Finolex and RR Kabel, garner approximately 60%-62% market share and the balance 38%-40% is constituted by challenger brands like Syska and V-Guard. Branded players are estimated to capture approximately 80% (approximately ₹ 96,000 crore) market share by Fiscal 2027.

Exhibit 3.6: Share of Branded Players in Indian W&C Market – By Value (Fiscal Year)

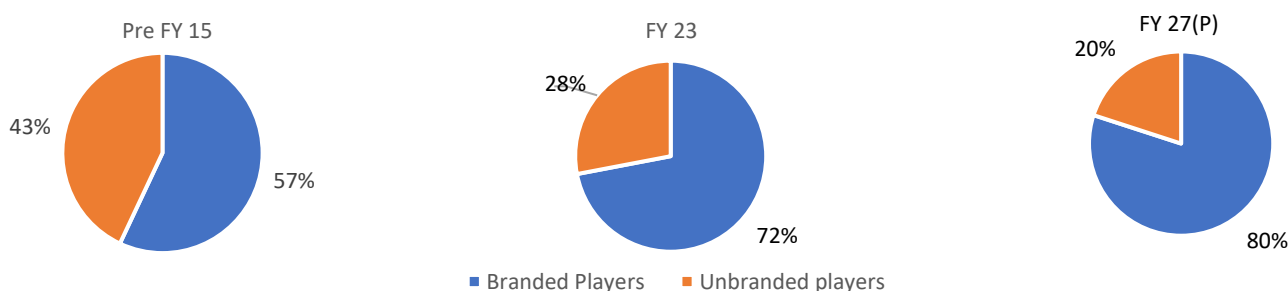

Source – Technopak Analysis

The W&C market in India has steadily moved from largely unbranded play towards branded play including regional and national players, because of reasons such as rising awareness among consumers towards safety and quality, advent of GST regime etc. Apart from these, the consolidation of branded play of the wires and cables market over unbranded play is driven by two other factors:

- **Technological innovations:** Continuous product improvement in the W&C industry, owing to technological interventions and innovations by branded players have made it difficult for unbranded players to compete. Innovations like LS0H, unilay core technology (“UCT”) have created favorable product differentiation for the branded players in the market.
- **ATL focused brand building by branded players:** Companies in W&C industry are focusing on brand building through ATL marketing. Marketing campaigns focused on, among other things, safety and durability are being designed in order increase consumer awareness. Television, print, outdoor (billboards, movie theatres) and digital media are being used extensively as marketing mediums for ATL brand building. Companies are also using celebrity endorsements to build their brands. Such advertising and marketing spend by large companies is a big business moat. and plays against small and medium unbranded players.
- **Distribution and Reach:** Branded players, through their strong distribution network servicing extensive retail footprint, have been able to cater to a broad segment of customers, ranging from Metro and Mini Metro cities to tier III and beyond cities as well as in rural areas. This has accelerated the growth of branded play in the market.

The share of branded play in the W&C market by value, is expected to grow to approximately 80% by Fiscal 2027 owing to factors such as GST implementation, execution of the BEE star norms, improvement in efficiency and cost structure of branded players resulting in the reduction of price gap between the branded and unbranded play, and economies of pan-India distribution network.

In W&C market, share of branded player in sub-categories like housing wires and power cables is approximately 55% and 65%, respectively as of Fiscal 2023 and these sub segments are expected to witness a substantial shift in share by Fiscal 2027, capturing approximately 70% and 75%, respectively. Other sub-segments like flexible and specialty cables, communication cables and control and instrumentation cables are mostly branded, with branded players controlling approximately 80-85% of the market as of Fiscal 2023. These sub-segments are also expected to witness a slight increase in branded share, controlling approximately 85-90% of the market by Fiscal 2027.

Exhibit 3.7: Share of Branded Play within sub-categories of Indian W&C Market – By Value (Fiscal Year)

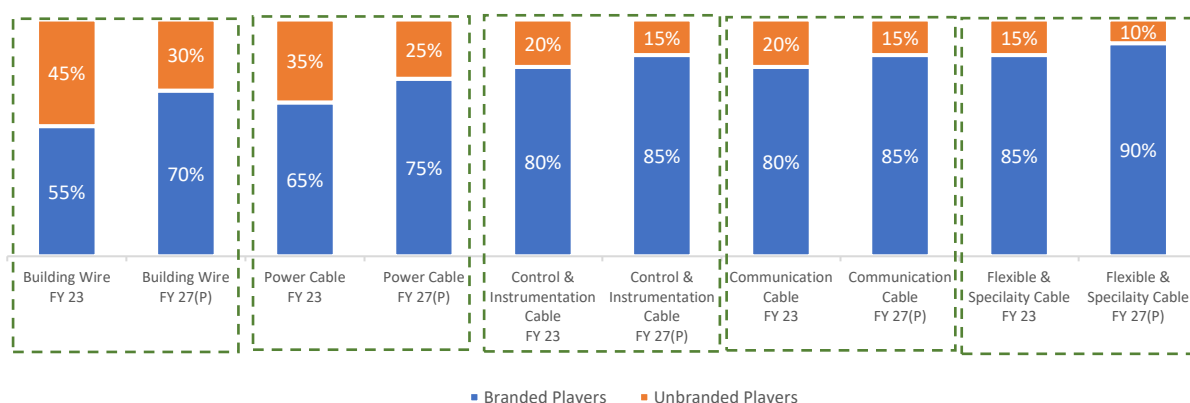

Source – Technopak Analysis

- **New Technological Interventions**

Increasing technological interventions in W&C industry with an objective of achieving more safety and energy efficiency, are pivoting the market towards branded players. Few of the recent technologies introduced in the industry are provided below:

- **LS0H:** Low smoke zero halogen wires and cables have cable jacketing and insulation, made up with materials that produce low smoke and non-toxic halogens on being exposed to fire or high temperatures. Such type of material is used in poorly ventilated areas such as aircraft and rail carriages. In fire incidents, low smoke factor of the cable would help in maintaining visibility and reducing respiratory damages, while zero halogen inhibits the production of toxic halogen gas. All the five leading players in the industry namely Polycab, KEI, Havells, Finolex and RR Kabel manufacture LS0H wires and cables. RR Kabel is the first company in India to introduce LS0H insulation technology in W&C products.
- **UCT:** W&C with UCT helps in saving space because of high density wiring. These have negligible chances of breakage while stripping the insulation, facilitating perfect contacts with compact bunching which helps in better conductivity and savings. Additionally, the increased mechanical strength of W&C minimizes breakage of strands, thereby giving enhanced safety. RR Kabel is the first company in India to introduce UCT (heat resistant and flame retardant) products.

- **E-beam (electron beam):** E-beam cross-linking technology protects wire and cable insulation from the heat of short-circuits because of high-temperatures. The processing improves a range of properties of W&C such as tensile strength especially at elevated temperatures, abrasion-resistance, thermal-resistance, cut through-resistance and shear and compressive strength. Electron beam cross linked wires and cables are green and eco-friendly in nature. Among leading players, Polycab manufactures e-beam wires and cables in the industry along with certain other players such as Apar Industries and Vindhya Telelinks.

- **Technical and Regulatory Compliance**

Many stringent technical standards and compliances have been laid out by various countries for wires and cables product. India has ISO 9001:2015, ISO 14001, ISO 45001 certifications for W&C product. Similarly, Europe has laid out regulatory compliances such as Registration, Evaluation, Authorization and Restriction of Chemicals (“**REACH**”); Restriction of Hazardous Substances Directive (“**ROHS**”) and Construction Products Regulations (“**CPR**”). Such technical and regulatory compliances require heavy investment, which has made unbranded players unviable, thereby pivoting the industry towards branded players. RR Kabel is the first company in India to launch products compliant with the European regulations such as REACH, ROHS and CPR. The manufacturing facilities of RR Kabel has 35 international product certifications as on June 30, 2023.

Key Growth Drivers of Domestic W&C Market

Apart from growth drivers impacting the electrical consumer market like rural electrification, growing real estate sector and various policy interventions by GoI to boost production, exports and promote ease of doing business, there are a few sector specific growth drivers of the W&C market.

- **Increase in per capita per annum electricity consumption**

The global average of per capita per annum electricity consumption is estimated to be approximately 3700 kWh in CY 2021. India’s per capita per annum electricity consumption is low, as compared to other countries like USA and China, at approximately 1255 kWh, there by suggesting headroom for growth in future. Such increase in per capita per annum electricity consumption is expected to drive the demand for W&C products like housing wires in India.

Exhibit 3.8: Per Capita Per Annum Electricity Consumption (in kWh) in CY 2021

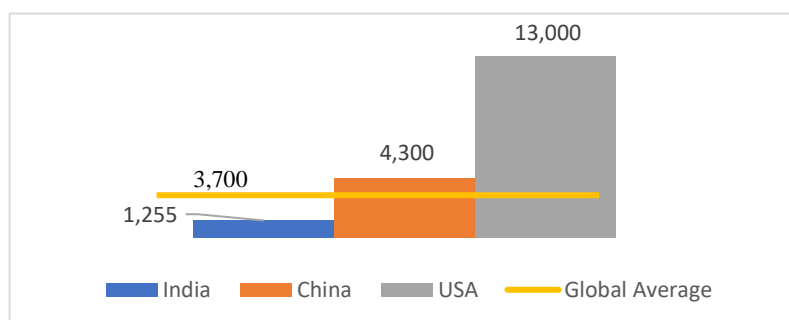

Source – Press Information Bureau, Government of India

Key Players in the Industry

The Indian W&C industry has been gradually moving from largely unbranded play towards branded play including regional and national players, as a result of rising awareness among consumers towards safety and quality, advent of GST regime, increasing technological and product complexities, as well as growing marketing and branding activities by branded players. Nearly 72% of the wires and cables market in India is controlled by branded play. Within this 72%, five leading players namely Polycab, KEI, Havells, RR Kabel and Finolex, garner approximately 60%-62% market share and the balance 38%-40% is controlled by challenger brands like Syska and V-Guard. Polycab is the market leader having approximately 16% market share by value, followed by KEI (approximately 8% market share), Havells (approximately 8% market share), Finolex (approximately 6% market share) and RR Kabel (approximately 5% market share). RR Kabel is the fifth largest player in wires and cables market in India, representing approximately 5% market share by value, as of Fiscal 2023. Within branded market, Polycab garners approximately 22% market share by value, followed by KEI (approximately 12% market share), Havells (approximately 11% market share), Finolex (approximately 9% market share) and RR Kabel (approximately 7% market share). RR Kabel is the fifth largest player in branded wires and cables market in India, representing approximately 7% market share by value, as of Fiscal 2023, as compared to approximately 5% market share by value as of Fiscal 2015. RR Kabel’s share in the domestic W&C market has increased from 3% in Fiscal 2015 to 5% in Fiscal 2023. The W&C category is a distribution led category wherein the role of distributors and retail touchpoints is critical for capturing the market. For instance, leading player RR Kabel has approximately 7,106 dealer and distributors spread across pan-India and has approximately 1,14,851 retail touchpoints as of June 30, 2023.

Exhibit 3.9: Presence of leading players in various sub-categories in W&C market in India

Players	Power Cable (LT/HT/EHV)	Control and Instrumentation Cable	Communication Cable	Housing Wires	Flexible and Specialty cables
KEI	✓✓	✓	✓	✓	✓
Havells	✓	✓	✓	✓	✓✓

Finolex	✓	✓	✓	✓✓	✓
Polycab	✓✓	✓	✓	✓	✓
RR Kabel	✓*	✓	✓	✓✓	✓

*RR Kabel does not manufacture EHV power cables

LT-Low Tension, HT-High Tension, EHV-Extra High Voltage

✓ - Presence, ✓✓ - Primary sub-category

Source – Secondary research and Technopak Analysis

Exhibit 3.10: Market share of players in domestic W&C market in India – by value (Fiscal 2023)2

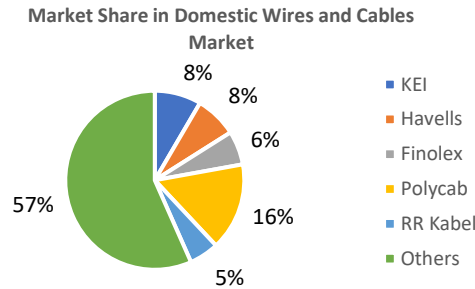

Source – Technopak Analysis

Exhibit 3.11: Market share of players in Domestic Branded Wires and Cables market in India – By Value (in Fiscal)

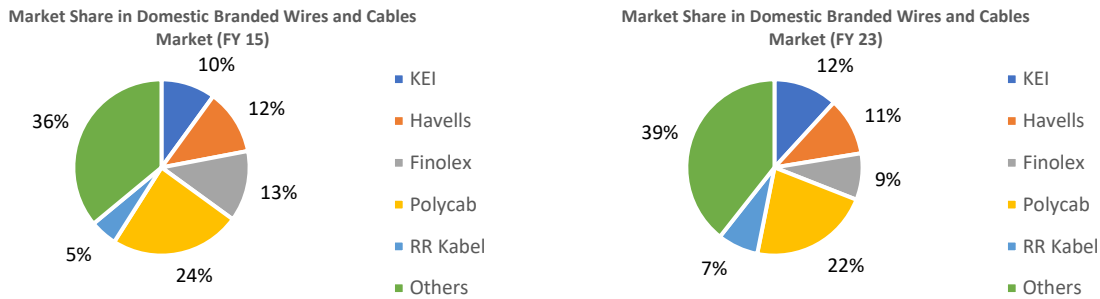

Source – Technopak Analysis

The W&C industry is a distribution-led traditional retailer driven category. A typical value chain involves manufacturing brands, distributors, retailers and customers. In case of housing wires, electricians form the major segment of customers in the value chain. In certain instances, manufacturers sell directly to institutions. There are also direct dealers in the market who buy the products from brand manufacturers and sell those, either to retailers or directly to the customers. Contractors, architects, institutional buyers and end-consumers form the customer base of W&C market. The distributor buys W&C from brand manufacturers usually at a discount of approximately 35-40%. The distributor can garner additional discount linked to turnover and cash discount. The distributor further sells the product to retailers and retains a margin of approximately 4-5%. Retailers sell the product to end consumers with a retained margin of approximately 5-6%. In instances where manufacturing brands sell directly to institutions, they give a discount of approximately 40-45% on the price. Where manufacturing brands sell their products to direct dealers, they give a discount of approximately 35-40% and additional turnover / cash discounts of approximately 5-6%. Direct dealers retain a margin of approximately 3-4% while selling to retailers and approximately 4-5% while selling directly to end consumers.

A pan-India distribution network provides players high channel partner stickiness and wider reach. New entrants / regional players require more time to build a similar network, thereby providing the pan-India players a significant market place advantage. For instance, RR Kabel has a pan-India distribution network with over 785 employees in its sales force and has one of the largest network of electricians, covering 271,264 electricians across India as on March 31, 2023, which has grown to 298,084 electricians as on June 30, 2023.

Exhibit 3.12: Number of electricians of key players in Fiscal 2023

Player	Number of electricians in Fiscal 2023
RR Kabel	2,71,264
KEI	NA
Polycab*	1,80,000

Havells
Finolex

2,50,000
NA

*For Polycab, the number of electricians is as per Fiscal 2022. NA- Not Available
Source – Technopak Analysis

Sales Channels and Share of each Channel

Exhibit 3.13: Sales of W&C across sales channel (Fiscal Year)

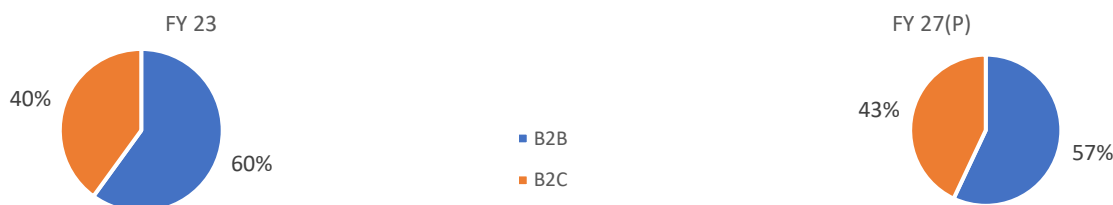

Source – Technopak Analysis

As per industry convention, A product’s end use determines whether the sale is through a business-to-business (B2B) or business-to-consumer (B2C) channel. In terms of revenue contribution from B2C sales channels in wires and cables, RR Kabel has the highest contribution with approximately 74% of the revenue coming from B2C sales channel as of Fiscal 2023.2

Exports and imports of W&C

Indian W&C industry exported products valued approximately US\$ 1,717 million in CY 2022. It majorly exports to USA constituting approximately 23% of exports, followed by UAE (8%) and UK (8%). As of CY 2022, RR Kabel is one of the leading exporter of wires and cables from India, in terms of value, representing an approximately 9% market share (pertaining to FY 23 revenue of RR Kabel) of the exports market from India.

Approximately US\$ 1,217 million worth of W&C products were imported from across the globe by India in CY 2022, wherein China accounts for approximately 34% of the imports followed by USA (10%), Germany (8%) and Korea (5%).

Exhibit 3.14: Export and Import of W&C in US\$ Million (CY)

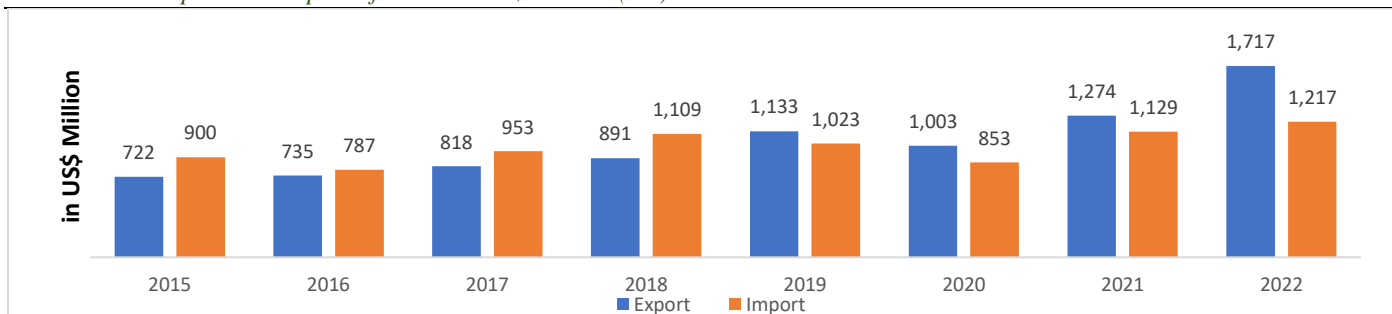

Source – ITC Trade Map and Technopak Analysis, HS Code: 8544

Indian W&C market became net export positive for the first time in CY 2019 and has been export positive since then. This shows the widespread acceptability of Indian W&C product worldwide. W&C export market has grown at a CAGR of 11% from CY 2015 to CY 2022 and is expected to grow positively in future. This growth would be driven primarily by four factors:

- China plus one strategy:** In 1990s, many global manufacturing entities in geographies such as US and Europe shifted their production facilities to China owing to favorable factors of production, which made it the center of global supply chain. But in CY 2021, when there was a surge in demand across the world post-COVID-19 pandemic, China’s zero COVID policy and supply chain disruption issues made it difficult for these manufacturing entities to meet the demand. As a result, such companies are contemplating diversifying their business and investment out of China to alternative destinations. Technopak believes that this China plus one strategy presents a great opportunity for India because of its large manufacturing base, favorable factors of production, strong business ecosystem, and incentivizing government policies, which in turn, is expected to help in growing the exports market of Indian W&C industry. Leading players like RR Kabel are well-positioned to benefit from the global shift away from China-based manufacturing to China plus one strategy resulting in a share gain for Indian manufacturers in the global market.
- Export Incentives:** Various policy interventions by GoI to promote export of goods and services is expected to further boost the exports market for W&C in India. For instance, AAS and the EPCG Scheme are being implemented to enable duty free

import of raw materials and capital goods for export production. RoDTEP scheme has also been introduced which rebates various central, state, and local duties/ taxes on exported products.

- **Technical and Regulatory Compliance:** Many stringent technical standards and compliances have been laid out by various countries for wires and cables product. For example, Europe has laid out regulatory compliances such as REACH, ROHS and CPR. RR Kabel, a leading company, has over 35 international product certifications, which has enabled them to export its products to global markets.
- **Transition towards clean and green energy:** Commitment of various countries towards achieving a cleaner and greener environment, for instance, the Paris agreement, and net zero emission have resulted in increasing adoption of renewable projects across the globe. These are expected to increase the demand for W&C in the global market, which in turn would provide a great opportunity for Indian exports.

Exhibit 3.15: Export and Import share by countries of W&C (CY 2022)

Export Share by countries (CY 22)

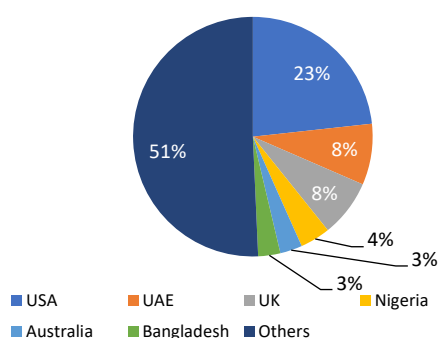

Import Share by countries (CY 22)

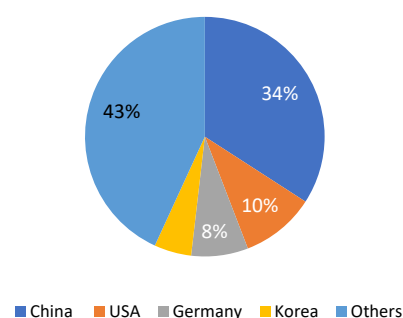

Source – Secondary research and Technopak Analysis

Exhibit 3.16: Export revenue of leading W&C players (Fiscal Year)

Players	Exporting to # countries	Export Revenue in ₹ Crore (Fiscal 2023)	Export Revenue in ₹ Crore (Fiscal 2022)	Export Revenue in ₹ Crore (Fiscal 2021)	Export Revenue in ₹ Crore (Fiscal 2020)
RR Kabel	63	1,270	1,007	583	502
KEI	60+	693	585	627	879
Havells	70+	294	504	361	317
Finolex	USA and UAE	43	28	31	26
Polycab	70+	1,383	842	747	1,095

Note - For RR Kabel, KEI, Finolex and Polycab, 100% of exports come from wires and cables, whereas for Havells 60% of exports come from wires and cables
NA - Not Available

Source – Secondary research and Technopak Analysis

Key Risks and Challenges

- **Volatility in prices of raw materials**

Prices of raw materials such as copper and aluminum have been volatile over the past few years. Copper price was \$8,043 per ton in January 2012, which has increased to \$8,386 per ton in June 2023, reaching the decade high price of \$10,238 per ton in March 2022. The prices of copper have been highly volatile exhibiting a steep decline from \$10,238 per ton in March 2022 to \$7,530 per ton in July 2022. Likewise, the price of aluminum has also increased from \$2,144 per ton in January 2012 to \$2,181 per ton in June 2023, reaching the decade high price of \$3,538 per ton in March 2022. The increase in prices of raw materials poses a key challenge to W&C manufacturers as it leads to an increase in raw material costs. This increase can either be passed on to the consumer or absorbed by the manufacturer or a combination of both. As per industry convention, the corresponding increase in prices of copper and aluminum has been passed on to the consumers historically, in a lagged manner. The corresponding increase in price may lead to a reduction in sales volume. Based on overall industry dynamics and macroeconomic factors, the revenue (price*volume) and profitability of players is likely to be impacted.

Exhibit 3.17: Copper LME Price (US\$/Ton) and Aluminum LME Price (US\$/Ton) from CY 2012 to June CY 2023

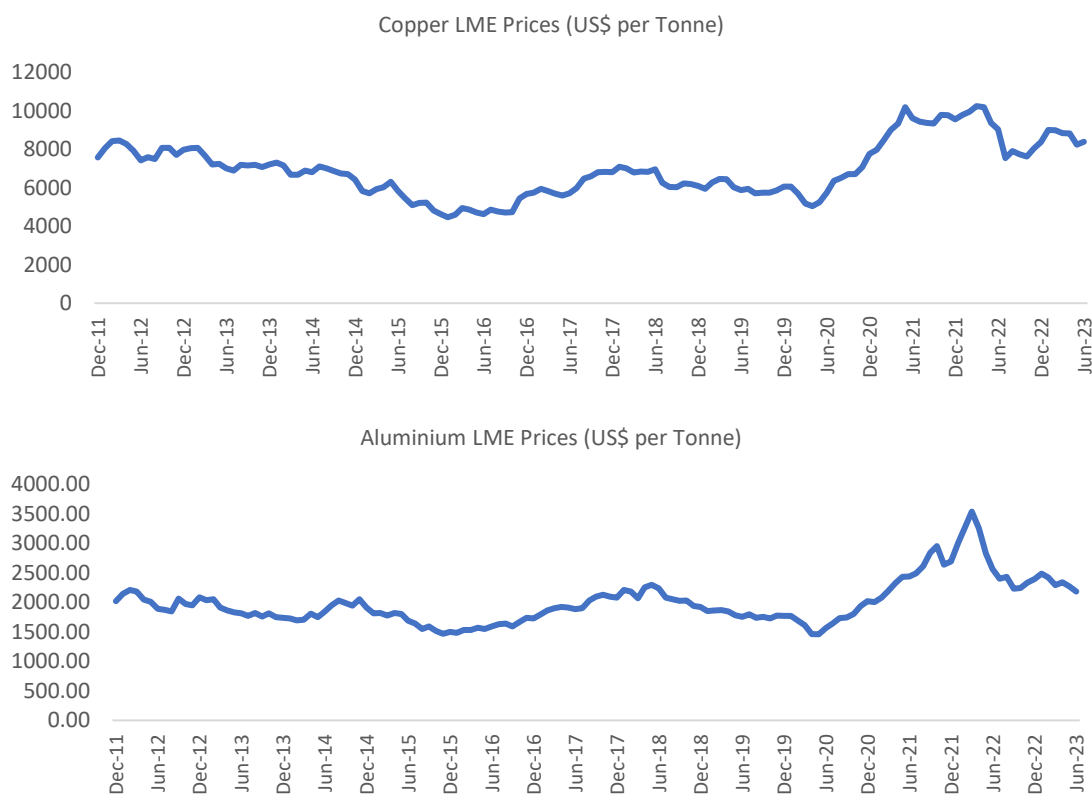

Source – Secondary research and Technopak Analysis

- **Fluctuation in currency exchange rate**

Fluctuation in rupee-dollar exchange rate also poses a key challenge to the W&C industry. The average rupee-dollar exchange rate was ₹ 74 in CY 2021, which had increased to ₹ 83 in October 2022. Players may import raw materials such as aluminum, insulation materials because of economies of cost and quality, which when exposed to exchange rate fluctuation, may result in increase in overall cost, thereby impacting the margin.

Section 4: Fan Market in India

Industry Overview

- Fans Market Size**

The total market for fans has grown at a CAGR of approximately 12% from ₹ 5,690 crore in Fiscal 2015 to ₹ 13,875 crore in Fiscal 2023 and is further expected to grow at a CAGR of approximately 7% till Fiscal 2027 to reach a market value of ₹ 18,500 crore.

Exhibit 4.1: Fan Market in India – By Value (Fiscal Year)

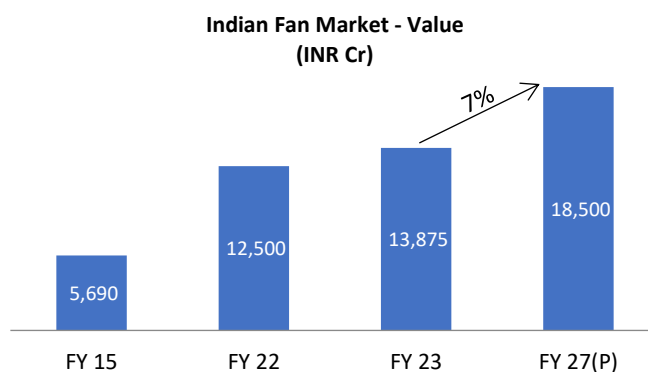

Source – Technopak Analysis

Note: This does not include exports.

- Key sub-categories of Fans**

The fan market in India can be sub-divided into three key segments as ceiling fans, table, pedestal and wall (collectively, “TPW”) fans and fans such as industrial and exhaust fans (“**Other Fans**”). While ceiling fans account for approximately 72% of the fan industry in India followed by TPW fans constituting approximately 20% of the industry, Other Fans account for the balance 8% of the industry in Fiscal 2022, based on value. Ceiling fans are primarily used in households and commercial establishments, whereas primary installation places for table fans are small shops and workplaces.

Construction of new houses, replacement demand in existing households, increase in installation ratio of fan per household and successful execution of energy efficiency norms are expected to provide the required impetus for increase in demand of fans in India. Additionally, the growth in fan exports because of global requirements is also expected to drive the production of fans in India.

- Ceiling Fan Market**

The total market for ceiling fan has grown at a CAGR of approximately 12% from ₹ 4,100 crore in Fiscal 2015 to ₹ 9,990 crore in Fiscal 2023 and is expected to grow at a CAGR of approximately 8% till Fiscal 2027 to reach a market value of ₹ 13,500 crore.

Exhibit 4.2: Indian Ceiling Fan Market – By Value (₹ Cr)

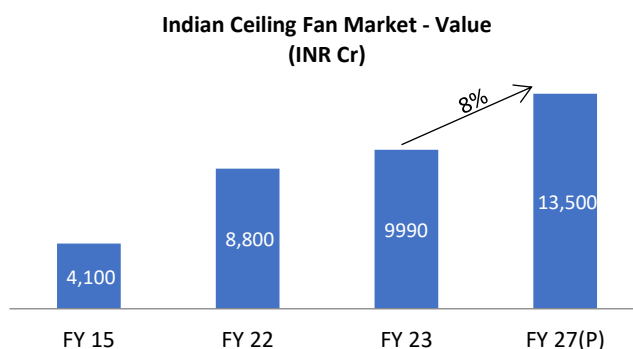

Source – Technopak Analysis

Note: This does not include exports.

- **Price Segmentation - Ceiling Fans**

As per price points, the entire ceiling fan market can be categorized into three price segments namely economy, standard and premium.

Exhibit 4.3: Price segmentation of Ceiling Fans

Segment	Price range	Examples
Economy	<₹ 1,500	Luminous Morpheus 1200 mm 3 Blade Ceiling Fan, Crompton Jura 1200mm 3 Blades Ceiling Fan, Oriental-Stellar 600mm Stylish Fan, Havells SS390 1200 mm 3 Blade Ceiling Fan
Standard	₹ 1,500 – ₹ 4,000	RR Kabel White Ceiling Fan with Remote, Standard Zinger 1200 mm 3 Blade Ceiling Fan by Havells, Crompton Alpha Broz 1200 mm 3 Blade Ceiling Fan, Crompton Gianna 900 mm 3 Blade Ceiling Fan
Premium	>₹ 4,000	Luminous Lucrezia 1320mm Remote 5 Blade Ceiling Fan, Havells Stealth Puro Air 1250mm 3 Blades Ceiling Fan, Orient Stallion-1 1200 mm 4 Blade Ceiling Fan, Orient Electric Aero slim 1200mm 3 Blades Ceiling Fan, Crompton Nebula 4-Blade Ceiling Fan

*The above segmentation is as per Fiscal 2023.
Source – Secondary research, Technopak Analysis*

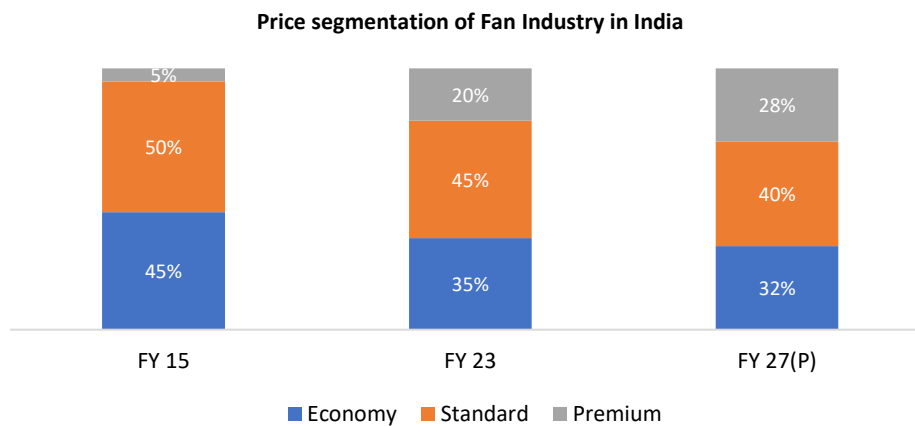

Source – Secondary research and Technopak Analysis

The fan industry in India is steadily shifting towards premium segment, with approximately 20% market share in Fiscal 2023, as compared to approximately 5% market share in Fiscal 2015. Increase in disposable income have enhanced the purchasing power of people, which has resulted in increased demand for technologically advanced and aesthetic fan products. Production of smart and IoT- enabled ceiling fans, enhanced design in terms of color and aesthetics of ceiling fans, feature reinforcement through air purification and bladeless features are expected to serve as the key drivers of premiumization in the Indian fan market. The fan market is benefiting from the drivers of premiumization, which can be evidently witnessed in the rising share of premium products in the overall fan market. The premium segment is expected to garner approximately 28% market share by Fiscal 2027. Many leading and challenger players are launching premium and decorative fans. For example, RR Kabel has launched Luminous Audie 1200mm Smart Ceiling Fan in the premium segment, which is an IoT enabled and Alexa compatible smart fan. Havells has also launched a Stealth Puro Air premium ceiling fan having 3-stage filtration and air purification benefits. Atomberg’s Gorilla fans not only have the feature of remote-control but also a sleep mode and timer mode that can be pre-set.

On a regional level, the fan market has been classified into North India, West India, South India, and East India, where South India currently dominates the market with approximately 30% market share by value in Fiscal 2023.

- **Trends shaping the Domestic Fan Market**
- **Shift towards Branded Play**

As of Fiscal 2023, Indian ceiling fan market is primarily dominated by branded players, controlling close to 91% of the market, out of which 4-5 top players garner approximately 80% market share. These leading players include Crompton Greaves, Havells, Orient Electric, Bajaj Electricals, and Usha. The remaining share of branded play market is contributed by challenger brands like RR Kabel and V-Guard. Branded players are estimated to capture approximately 95% market share by value by Fiscal 2027.

Exhibit 4.4: Share of Branded Play in Indian Ceiling Fan Market – By Value (Fiscal Year)

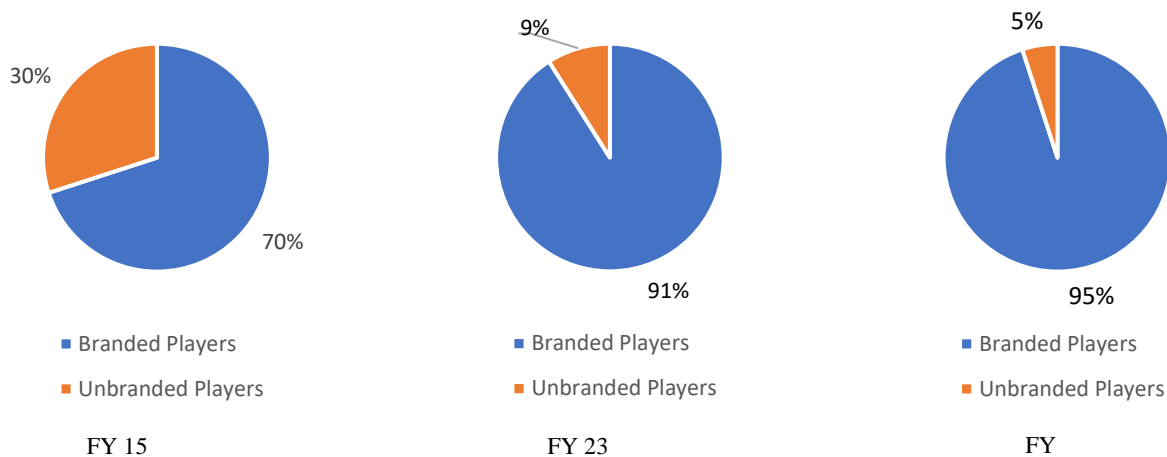

Source – Technopak Analysis

Apart from rising awareness among consumers to seek safe and quality products and the advent of GST regime, consolidation of branded players in the ceiling fan market over unbranded player is driven by two factors:

- Energy efficiency labelling system:** Voluntary star labelling for ceiling fans was introduced by BEE in CY 2019 and star labelling has been mandated in CY 2023. The evolution of this category with good practices around energy efficiency is pivoting the market towards branded play. Unbranded play does not subscribe to energy efficiency, safety practices, standardization etc. and the only leverage they have is price. Owing to the energy efficiency rating system, it would be difficult for them to compete in the market and eventually they would be crowded out by branded play. The overall Indian ceiling fan market would eventually converge into all fans being star rated.
- Entry of new players as part of their product extension growth strategy:** Strategic investments and brownfield expansion in fan sector by players in the adjacent categories have enabled the growth of branded share. For example, Havells delved into fans category as part of their business diversification strategy in CY 2003. In CY 2014, Polycab diversified its portfolio by entering into fans segment. Challenger brands like RR Kabel, who were already present in economy and standard segment of fans, forayed into premium segment in CY 2022 through brownfield acquisition of Luminous Power’s home electrical business (HEB). The sector has also witnessed greenfield expansion into branded play of various players such as Atom Berg, Halonix Technologies etc. pitched around energy efficient fans. Henceforth, these have led to an increase in market share for branded play. This also implies that while approximately 90% of the total branded market is controlled by 4 to 5 players, going forward it is expected that 95% of the branded play will be split across nearly a dozen players that would include players like Havells, Crompton Greaves, RR Kabel, V-Guard etc.

Energy Efficiency

Demand for energy efficient fans has been rising as Indian consumers are increasingly aware of the advantages of having energy efficient appliances. On an average, ceiling fan constitutes 20% of the electricity consumed by an Indian household. Brushless Direct Current (BLDC) technology makes ceiling fan highly energy efficient by reducing the energy consumption to almost one-third of a regular induction motor fan. These fans are rated as 5-star energy efficient fans. Cost of BLDC fans are typically on a higher side because of the complex technology and electronics involved. Owing to the shift in consumer mindset towards energy efficient fans, leading fan manufacturers such as Crompton Greaves, Orient Electric and challenger brands like RR Kabel and new entrants like Atom Berg, Halonix Technologies, have been extensively manufacturing BLDC fans over the past few years.

Introduction of mandatory norms in ceiling fans in CY 2023 is expected to enable the industry to witness a similar transition as in the lights and bulb category. Lights and Bulb category were earlier not mandated through any energy efficient norms. Introduction of voluntary and mandatory norms in LED lamps in CY 2015 and CY 2018, respectively, along with certain initiatives from government schemes, have resulted in energy efficient LED lights capturing approximately 95% of the market in Fiscal 2020, as compared to 20% in Fiscal 2014. Similarly in ceiling fans category, approximately 9% of the overall market was star rated in Fiscal 2018, which became 50% in Fiscal 2022 after the introduction of the voluntary star labelling program. In the next decade, it may reach in excess of 90%.

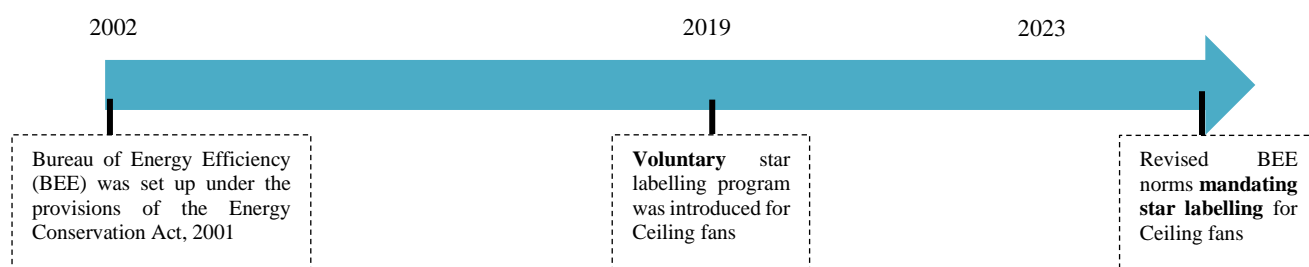
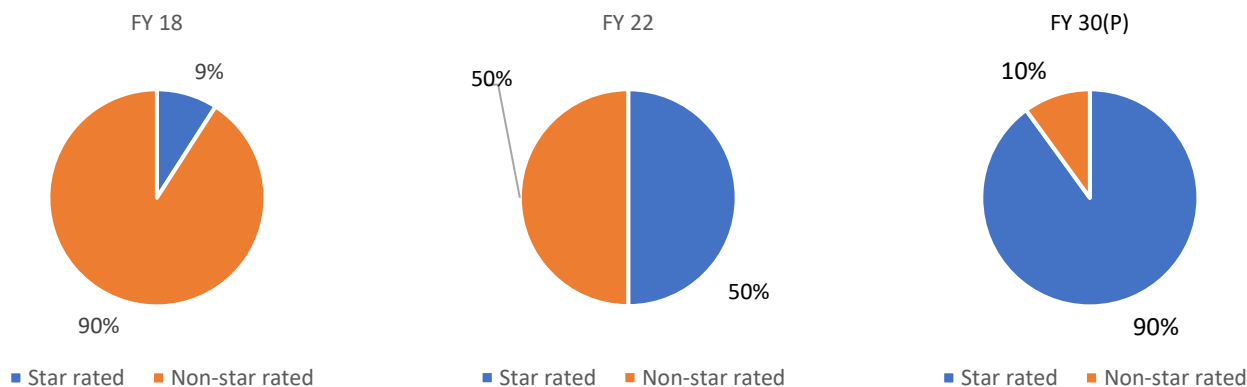

Exhibit 4.5: Share of Star rated Ceiling Fans in Indian ceiling fan market (Fiscal Year)



Source – Secondary research, Technopak Analysis

Exhibit 4.6: Examples of Energy Efficient Fans by Players in the Ceiling Fan segment

Players	Examples of Energy Efficient Fans
RR Kabel	Luminous New York Chelsea 1200MM Ceiling Fan
Crompton Greaves	Energion HS BLDC Ceiling Fan
Orient Electric	Aeroslim BLDC motor Smart Ceiling Fan
Havells	Efficiencia Neo 1200mm Ceiling Fan
Atomberg	Efficio 5-Star Ceiling Fan

Source – Secondary research and Technopak Analysis

• **Premiumization**

Buying behavior of Indian household for ceiling fans have changed considerably over the past few years. Increase in disposable income have increased the purchasing power of customers, which in turn have accelerated the demand for premium fans in India. Now, buyers do not view fan as a commodity which serves only the basic purpose but are also looking at their aesthetic quality which is going to add to the décor of the house. Consumers are showing more and more interest towards smart, easy-to-use, and technologically advanced products. Smart ceiling fans and IoT- enabled ceiling fans are no longer a discretionary spend but are viewed as an integral part of home interiors. The smart fans / IoT- enabled fans connect through the internet and can automatically adjust its speed as per the temperature and humidity in the room. It can be controlled via remote, mobile application and Wi-Fi connectivity. Production of smart and IoT-enabled ceiling fans, enhanced design in terms of color and aesthetics of ceiling fans, and feature reinforcement through air purification and bladeless features are expected to serve as the key drivers of premiumization in the Indian fan market.

RR Kabel has Luminous Audie 1200mm Smart Ceiling Fan in premium segment, which is an IoT enabled and Alexa compatible smart fan. Orient Electric has also launched an Aeroslim fan, which is enabled with IoT technology that enables users to manage fan speed and modes, reverse rotation and under light with dimming options via a mobile application.

• **Key Growth Drivers of Domestic Fan Market**

Apart from growth drivers impacting the electrical consumer market like rural electrification, increase in retail, commercial and residential establishments and various policy interventions by Government of India, there are a few sector specific growth drivers of the domestic fan market.

• **Premiumization**

Indian fan market is witnessing increased demand for premium fans as there has been a shift in consumer mindset towards products which are smart, have enhanced design in terms of color and aesthetics and have superior functionalities. The reason for the same can be attributed towards increase in disposable income of people, which has increased the purchasing power of customers. The premium segment of fan market is constituting approximately 20% market share by value in Fiscal 2023, as opposed to approximately 5% market share in Fiscal 2015. It is projected to constitute approximately 28% market share by value by Fiscal 2027.

- **Shift towards Branded Play**

Currently the share of branded market in India is approximately 91%. Owing to energy efficiency norms and heightened consumer awareness towards quality and safety, the Indian fan market is pivoting towards branded play and is expected to grow as high as approximately 95% by Fiscal 2027. Reduced urban replacement cycle as well as premiumization are also playing a pivotal role in driving the market towards branded play.

- **Increase in Replacement Demand**

Increase in disposable income and shift in consumer mindset from viewing a fan as a basic commodity to something that is going to add to the aesthetics and décor of the house, is driving the replacement demand of fans in India. In Fiscal 2022, approximately 4 million units of ceiling fans were sold as replacements. Replacement demand is expected to drive growth of both economy and premium segment fans.

- **Fan as a cost-effective cooling proposition**

Fan is a very cost-effective cooling proposition over all other established mediums in the market. One of the key reasons for ceiling fan to continue to grow in a market like India is because of its proposition to provide cooling and comfort for value. There is no other product / technology that can replace fan to cater to the value proposition that is being offered. Air conditioning has issues around affordability and installation. That is why, in spite the core technology of fans now commoditized, and their demand being plateaued in developed markets, their proposition around affordable convenience continues to witness a growing demand in a developing and price sensitive market like India.

Key Players in the Industry

Indian fan market is primarily dominated by branded players, controlling close to 91% of the market. 4-5 leading players garner close to 80% of the market. These leading players include Crompton Greaves, Havells, Bajaj Electricals, Usha and Orient Electric. Crompton Greaves is the market leader having approximately 23% market share by value, followed by Havells (approximately 19% market share), Bajaj Electricals (approximately 14% market share), Usha (approximately 14% market share) and Orient Electric (approximately 12% market share). The remaining share of branded play market is controlled by challenger brands like RR Kabel (approximately 3% market share), V-Guard etc. The fan category is a distribution-led category where in the role of distributors and retail touchpoints are critical for capturing the market. Leading players like Havells have close to 17,000 distributors spread across India and have approximately 2,22,000 retail touchpoints. In the premium segment, Havells has captured approximately 45% of the market and Crompton Greaves has close to approximately 35% of the market share. Fan category serves as an important category for some of the leading players in electrical consumer durables industry, contributing close to 45-50% of the total revenue. Fans contribute approximately 55% of the total revenue of Orient Electric, whereas approximately 45% of the total revenue of Crompton Greaves and Usha comes from fan category.

Exhibit 4.7: Market share of players in Domestic Fans Market in India – By Value (Fiscal 2023) 2

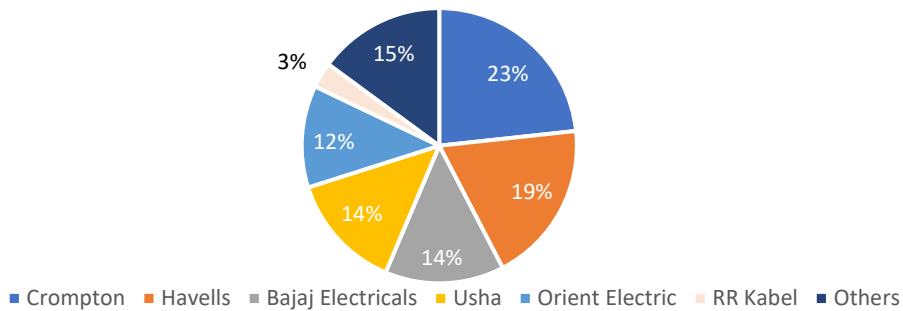

Source – Technopak Analysis

Fan market is a distribution led retailer driven category, that behaves similarly to a non-food FMCG category. A typical value chain involves manufacturing brands, distributors, retailers and customers. Manufacturers in some cases sell directly to institutions. There are also direct dealers in the market who buy the products from brand manufacturers and sell those either to retailers or directly to the customers. Contractors, Architects, Institutional buyers and end consumers form the customer base of fan market. The distributor buys fan from brand manufacturer usually at discount of approximately 30-40%. He can garner additional discount in terms of turnover and cash discount. Then the distributor further sells the product to retailers with a retained margin of approximately 5-7%. Retailers sell the product to end consumers with a retained margin of approximately 18-20%. In scenarios where manufacturing brands sell directly to institutions, they give a discount of approximately 40-45% on the price. Where manufacturing brands sell their products to direct dealers, they give a discount of approximately 30-40% and additional turnover / cash discounts of approximately 5-7%. Direct dealers retain a margin of approximately 5-15% while selling to retailers and approximately 16-18% while selling directly to end consumers.

Sales Channels & Share of each channel

Sales channel mix for fans in India consists of Traditional (Distribution and Trade), Modern Brick and Mortar, e-commerce, and Institutional sales channel. Fan segment is a distribution led category wherein a large and efficient distribution network plays a key role in capturing the market. In Fiscal 2023, Sales of fan through Traditional channels is approximately 80% and it is expected to continue to be a substantial channel of sales in upcoming years also. The share of e-commerce sales channel is approximately 6%. Even though the share of e-commerce is increasing, it is expected to remain less than 10% in the next 3-4 years. Modern Brick and Mortar store have a sales mix of approximately 9%. Approximately 5% of the sales happen through institutional channels (private and government projects).

Exhibit 4.8: Sales of Fan across retail channel (Fiscal Year)

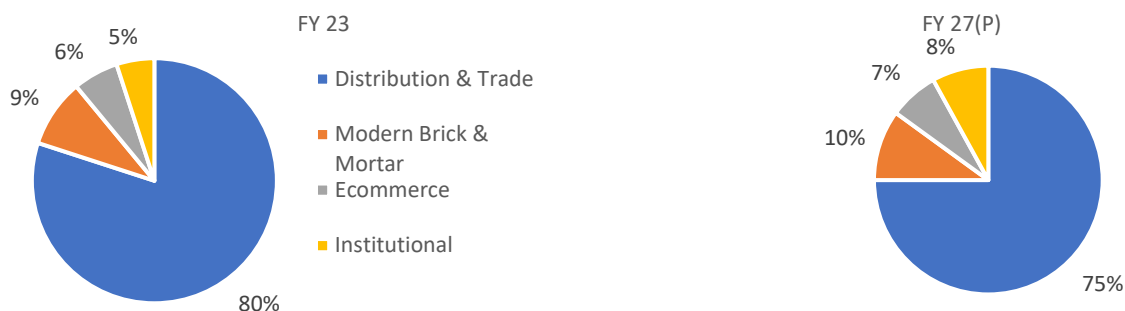

Source – Secondary research and Technopak Analysis

Exports & Imports of Fans

India exported fans valued approximately US\$ 70 million, which is approximately 4% of Indian production in CY 2022. India’s fan exports constitute 1% of the world exports. It majorly exports to UAE constituting approximately 31% of fan exports, followed by Nepal (21%) and Iraq (7%). Approximately US\$ 58 million worth of fan products were imported from across the globe, of which imports from China accounts for approximately 60%, including high end fans or very specialized fans at customized price points. Indian fans market became net export positive for the first time in CY 2021, signifying an important milestone for the Indian Fan manufacturers and widespread acceptability of Indian fan product worldwide.

Many western countries are witnessing higher temperature than the standard norms during summers because of climate change. Such extreme temperature shift in temperate regions in the last few years, has led to a steady demand for products like fans to adjust to the new reality. Thus, going forward, climate change may unlock export potential in disruptive ways from these regions and markets, and the export potential of fan may witness growing opportunities in its favor. Some of the leading brands like Orient Electric, Crompton Greaves, Havells, Bajaj Electricals, Usha and challenger brands like RR Kabel (incl. Luminous) and V Guard export fans from India.

Exhibit 4.9: Export and Import of Fans in US\$ Million (CY)

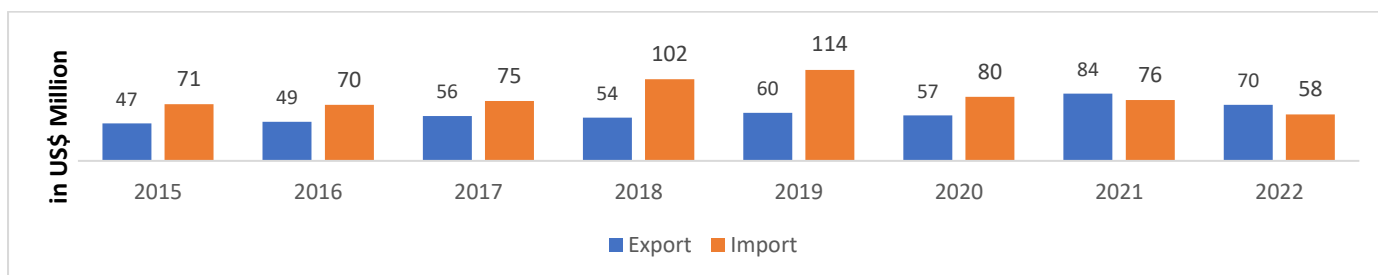

Source – Secondary research and Technopak Analysis; HS Code – 841451

Exhibit 4.10: Export and Import share by Countries for Fans (CY 2022)

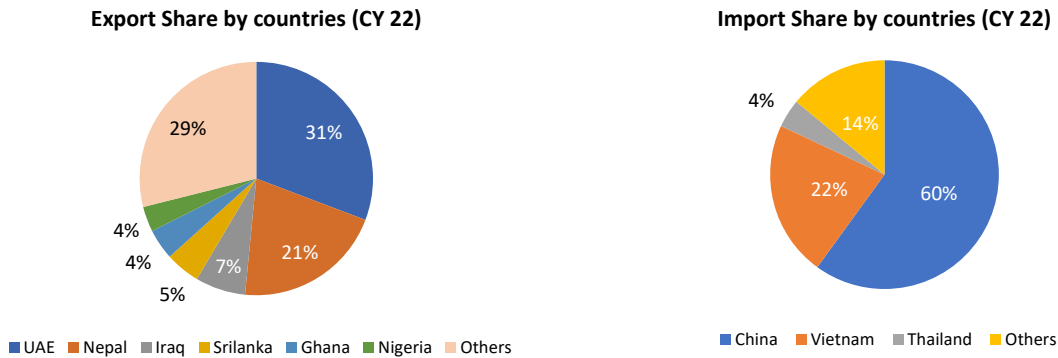

Source – Secondary research and Technopak Analysis

- **Key Risks and Challenges**
- ***Growth of substitute products like air coolers***

Substitute products to fans such as air coolers are witnessing an increase in demand, especially in residential and commercial spaces in urban areas. As these products are becoming more and more affordable, consumers are likely to opt for these alternatives, owing to their increase in disposable income.

- ***Rising raw material cost***

Inflation has been a global issue in the recent past in both developed economies like US & UK and developing economies like India. Wholesale Price Inflation ran into double digits in Fiscal 2022 in India, reaching 16.6% in May 2022, which was the highest in last 20 years. Consumer Price Inflation was approximately 5.5-6% in Fiscal 2022. These poses key challenge to fan manufacturers as inflation leads to increase in raw material costs, which eventually impacts the overall margin structure.

Section 5: Lighting Market in India

Industry Overview

- Lighting Market Size**

The total market for lighting in India was estimated at approximately ₹ 33,600 crore in Fiscal 2023 that grew at a CAGR of approximately 12% from ₹ 14,000 Cr. in Fiscal 2015. This market is expected to grow at a CAGR of approximately 11% till Fiscal 2027 to reach nearly to approximately ₹ 50,500 crore in annual sales.

Exhibit 5.1: Indian Lighting Market – By Value (₹ Cr) in Fiscal Year

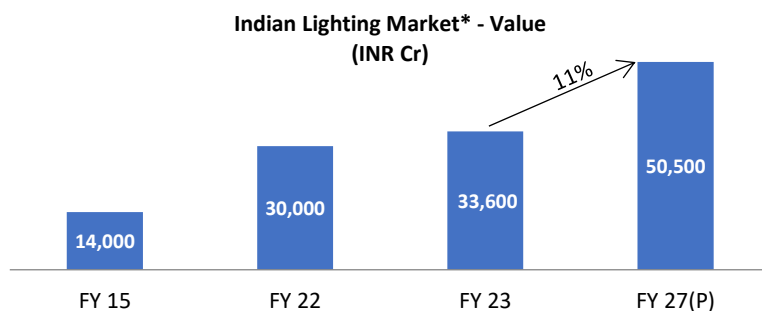

Source – Technopak Analysis

*Note-The data does not include export sales.

Key Segments of Domestic Lighting Industry

By Source Type

The lighting industry is sub-divided into LED and conventional lighting. LED makes up 84% of this industry (up from approximately 20% in Fiscal 2015) as of Fiscal 2023 and it is projected to reach 95% by Fiscal 2027. This is largely due to awareness of consumers towards, among other things, energy efficiency, longer life span of LEDs and reliability. Eventually, the LED segment is expected to completely replace conventional lighting.

Exhibit 5.2: Composition of Indian LED and Conventional Lighting Market – By Value (₹ Cr) in Fiscal Year

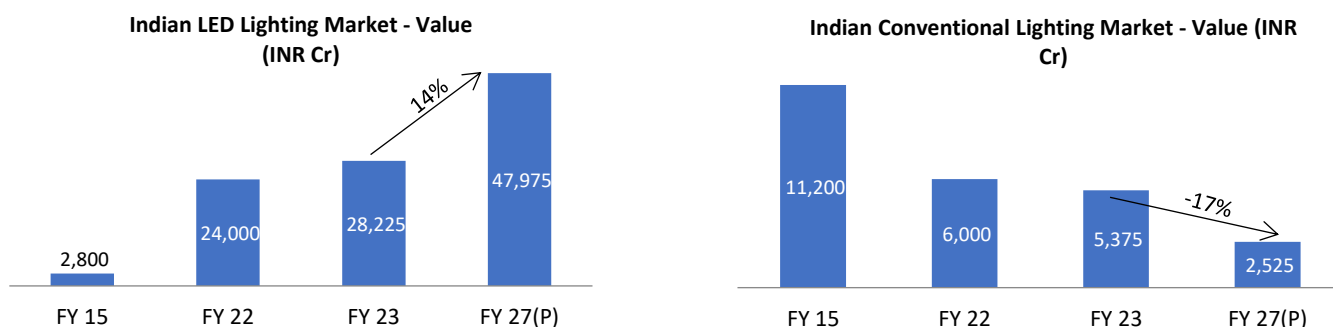

Source – Secondary research and Technopak Analysis

By Product Type

The lighting industry can be sub-divided into three key segments - bulbs, tube lights and downlights and panels. Bulbs account for approximately 50% of the lighting industry in India, followed by downlights and panels constituting approximately 30% of the industry and the balance of approximately 20% is contributed by tube lights. While bulbs and tube lights are primarily used in households and restaurants (including for decorative purpose), downlights and panels are primarily installed in commercial establishments and workplaces.

Exhibit 5.3: Break up of different segments of Lighting Industry in India (Fiscal Year)



Source – Secondary research

Basis price points, the lighting market can be categorized into two price segments namely economy and premium.

Exhibit 5.4: Price segmentation of Lighting Industry

Segment	Bulbs	Tube lights	Downlights & Panels
Economy	✓✓✓	✓✓	✓✓✓
Premium	✓✓	✓✓	✓✓

The above segmentation is as per Fiscal 2023.

Source – Secondary research

Note: ✓- Low penetration, ✓✓- Medium penetration, ✓✓✓- High penetration

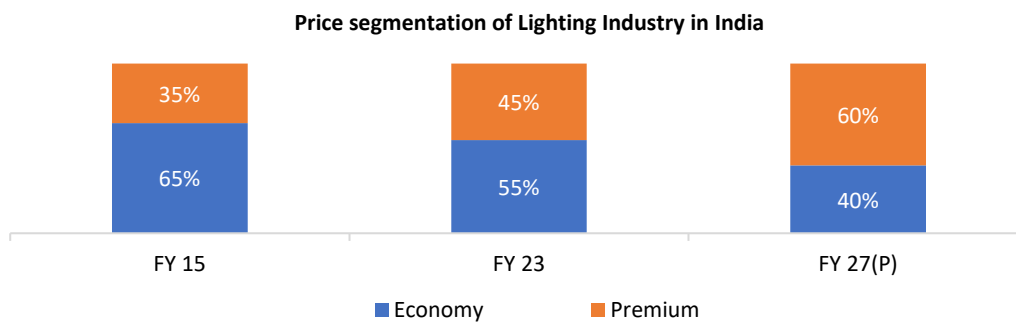

Source – Secondary research and Technopak Analysis

The lighting industry in India is steadily shifting towards premium segment, with approximately 45% market share in Fiscal 2023, as opposed to approximately 35% market share in Fiscal 2015. Many leading and challenger players are launching premium category of lighting. Havells has launched a Glamax smart batten, Aurom smart down lighter which can be operated using smartphone to alter the brightness or changing colors as well. The premium category are expected to contribute approximately 60% to the lighting market by Fiscal 2027.

Trends shaping the Domestic Lighting Market

- **Branded players compared to unbranded players**

As of Fiscal 2023, Indian lighting market is disproportionately distributed between branded and unbranded players with branded players occupying approximately 67% of the market (up from approximately 45% in Fiscal 2015). Top five branded players including Philips, Havells, Crompton Greaves, Surya and Syska contributed ₹ 8,500 crore to the overall market in Fiscal 2023. Challenger brands such as Halonix, Bajaj Electricals and RR Kabel contributed approximately 15% to branded play in the lighting market. Branded players are estimated to capture approximately 75% market share by Fiscal 2027.

Exhibit 5.5: Share of branded player vs Unbranded player in Indian Lighting Market

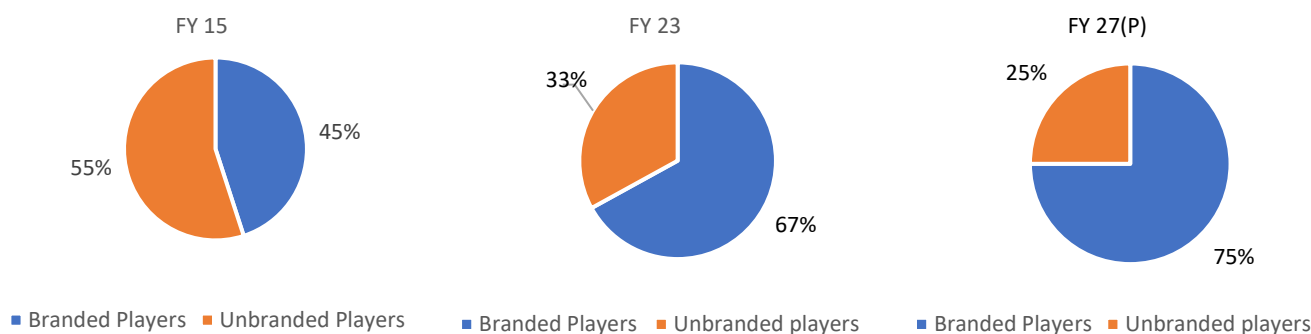

Source – Technopak Analysis

Apart from the advent of the GST regime, consolidation of branded players in the lighting market over unbranded players is driven by below mentioned factors:

- Energy efficiency:** The evolution of lighting category with norms and practices around energy efficiency is pivoting the market towards branded players. As per the revised mandate by BEE, manufacturers are bound to display star ratings and luminous efficacy on the lighting products especially LED products with power consumption in the range of 3 watts to 25 watts. To support this, GoI has banned a few ranges of conventional lights and has also mandated the application of LED lights in all government buildings. In addition, Bureau of India Standards (“BIS”) prohibits manufacturers of LED lighting products to produce, store, sell, import, export or distribute goods if the product is not approved by BIS or if the products do not comply with the set Indian standards. Unbranded players do not subscribe to, among other things, energy efficiency, safety practices and standardization and the only leverage they have is price. Owing to the energy efficiency rating system and standardization norms, it is likely to be difficult for them to compete in the market and they would likely be crowded out by branded players eventually.
- Institutional sales:** Institutional sales is one of the major drivers for branded players as unbranded players cannot participate directly in any form of government initiatives. Various government schemes such as Unnat Jyoti by Affordable LEDs for All (“UJALA”) and Street Lighting National Program (“SLNP”), that mandate the use of LED lights by replacing the conventional lights, support new demand for lighting products and play a critical role towards institutional sales thereby, increasing the demand for the branded players in the lighting industry.
- Entry of new players as part of their product extension growth strategy:** Strategic investments and innovative expansion in lighting sector by players in the adjacent categories such as Panasonic and RR Kabel, have enabled the growth of branded share. The branded players have introduced a new range of products in this segment such as smart lighting and internet of things (“IoT”) enabled lighting, thereby shifting the demand towards branded players.
- Premiumization**

The lighting market is absorbing the drivers of premiumization with the increase in disposable income of people, production of smart and IoT- enabled lightings, which can be directly connected to smartphones and other gadgets to control the system without any cable connectivity. This has resulted in increased demand for technologically advanced and aesthetic lighting products. Many leading and challenger players are launching premium category of lightings. For instance, Havells has launched Aurom smart down lighter which can be operated using smartphone to alter the brightness or changing colors as well.

Trends	Behavior
Smart lighting	Usage of main power lines to carry data to and from LED light fittings and everything is controlled without any cabled connectivity.
Built-in technology	Upcoming trend for the seamless look of built-in lights leveraging the fact that LED lights last much longer than ordinary ones.
Light fidelity technology (“Lifi”)	Technology where light and not radio waves transmit data between two endpoints and its penetration through wall is visible thereby alerting the consumer of unwanted intrusions.
IoT	IoT is a technology which not only connects smartphones and computers, but can also connect gadgets with household LED lights

Shift towards Built-in Downlights and Panels

Built-in downlights and panels are majorly used at commercial establishments and workplaces. Going forward, Technopak is expecting built-in downlights and panels to witness an increased demand in the lighting market and become a preferable choice in the future as compared to bulbs and tube lights owing to the issues such as warranty, thereby making bulbs less desirable.

LEDification- Technology shift towards LED altering the market structure aided by policy push

The Indian lighting market marked transition towards LED lights is due to various benefits specified below:

- **Energy efficiency** - LED lights consume 75% less energy, lasts 25 times longer than conventional lights and has high intensity, brightness and reliability. This has also been aggressively aided by various government initiatives such as UJALA and SLNP scheme.
- **Lower cost of ownership** - LED lights last much longer as compared to the conventional lights. This makes it affordable for consumers, when its price is viewed in the context of the lifecycle of ownership and encourages them to shift toward LEDs.
- **Innovation in new technologies**- Various smart lighting and IoT enabled technologies in LEDs have pushed manufacturers to innovate and launch new models in LEDs such as wireless lighting with sensor connectivity which has spurred the demand in the urban population whose living standards have improved with rising affordability for them. This trend is expected to continue growing in the coming years.
 - **Focus on localization of components for lighting industry**
 - Indian manufacturers are largely dependent on imports for sourcing the major LED components. This puts margin pressures on domestic manufacturers and the industry faces intense competition from Chinese imports. Also, there is increased competitive intensity that has been enabled by the entry of regional and local players that offer similar products at a cheaper price. These two factors of limited value addition in terms of LED components and competitive intensity, leads to reduced profit margins in the industry.

However, “Make in India” and “Atmanirbhar Bharat” initiatives by government that focuses on local manufacturing potential in India has included localizing of LED supply chain under its gambit. Under this policy initiative, the government has introduced PLI scheme for white goods to manufacture components and sub-assemblies of Air Conditioners and LED lights with a budgetary outlay of ₹ 6,238 crore. Currently, India imports 70% of the raw materials from other countries (China, Taiwan, Southeast Asia) to manufacture LEDs. Philips Lighting (Signify) is among the early adopters of this scheme that has started localization of components and now approximately 98% of the products are being locally manufactured by India.

Key Growth Drivers for Domestic Lighting Industry

Apart from growth drivers impacting the electrical consumer market like rural electrification, increase in retail, commercial and residential establishments and various policy interventions by GoI, there are a few sector specific growth drivers of the domestic lighting market.

- **Premiumization**

Indian lighting market is witnessing an increased demand for premium lighting features as consumers are showing more interest towards smart, easy-to-use, and technologically advanced products. Production of smart and IoT- enabled lightings such as wireless lighting where everything is controlled without any cable connectivity, built-in technology for the seamless look, Lifi, IoT which will connect smartphones, computers and other gadgets with household LED lights, sensor connectivity and automation lighting control to be operated with remote for those smart lighting solutions, are expected to serve as the key drivers of premiumization in the Indian lighting market, which in turn is expected to boost the overall demand for the lighting industry especially in the premium and super premium range.

- **Replacement Demand**

The awareness towards energy efficiency in urban population has led people to replace conventional lights with LED. Further, an increase in installation points of lights per household or workplaces is a key driver to increase demand for lighting products. With an increase in disposable income of people, consumers are showing more interest towards smart, easy-to-use, and technologically advanced products such as built-in lights or smart LED lights thereby, creating a demand for these products that can be replaced and used in new and existing constructions.

Key Players in the Industry

The leading players in the lighting industry include Philips, Havells, Crompton Greaves, Surya and Syska. Philips is the leader in Indian market with approximately 9% market share, followed by Havells and Syska.

Exhibit 5.6: Market share of players in Domestic Lighting Industry in India (Fiscal 2023)

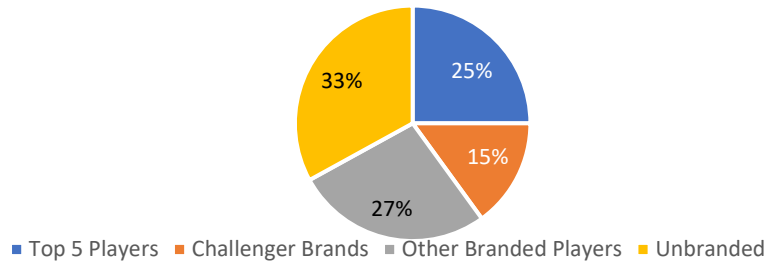

Source – Technopak Analysis ; Note- Leading players include Philips, Havells, Crompton Greaves, Surya and Syska. Challenger brands include players like Wipro, Panasonic, Bajaj Electricals and RR Kabel.

Lighting market is a distribution led retailer driven category, that behaves similarly to a non-food FMCG category. A typical value chain involves manufacturing brands, distributors, retailers and customers. Home buyers, institutions, contractors and architects form bulk of the customer base of the lighting market. The distributor buys lights from brand manufacturer usually at discount of approximately 30-40% and garners additional discount on upfront payment and volumes. Then the distributor further sells the product to retailers with a retained margin of approximately 5-8%. Retailers sell the product to end consumers with a retained margin of approximately 15-18%. In scenarios where manufacturing brands sell directly to institutions, they offer a discount of approximately 40-45% on the listed price. In cases where manufacturing brands sell their products to direct dealers, they offer a discount of approximately 30-40% and an additional turnover / cash discount of approximately 5-6%. Direct dealers sell to consumers with a retained margin of approximately 5-15%. Additionally, trade labels also exist along with the branded play in the lighting market. Price opacity and high margin play (going as high as 100%) are distinct features of the unstructured value chain of these trade labels.

Sales Channels and Share of each Channel

Sales channel mix for lights in India consists of traditional (distribution and trade), modern brick and mortar, e-commerce, and institutional sales channel. The lighting industry is a distribution-led category wherein a large and efficient distribution network plays a key role in capturing the market. In Fiscal 2023, Sale of lighting products through traditional channels is approximately 70% and it is expected to continue to be a substantial channel of sales going forward. Share of e-commerce sales channel is approximately 10% and modern brick and mortar store have a sales mix of 5%. Approximately 15% of the sales happen through institutional channels (private and government projects).

Exhibit 5.7: Sales of Lighting across retail channel (Fiscal Year)



Source – Secondary research and Technopak Analysis

Exports & Imports of Lightings

India exported lighting products worth US\$ 362 million in CY 2022. India majorly exports to USA constituting approximately 37% of exports, Germany (6%) and UK (6%). Approximately US\$ 674 million worth of lighting products were imported from across the globe by India in CY 2022, wherein China accounted for approximately 70% of the imports. Among the lighting manufacturers, Philips, Havells, Bajaj Electricals are some of the leading brands that exports lighting products from India.

Exhibit 5.8: Exports and Imports of Lightings (US\$ million) in CY

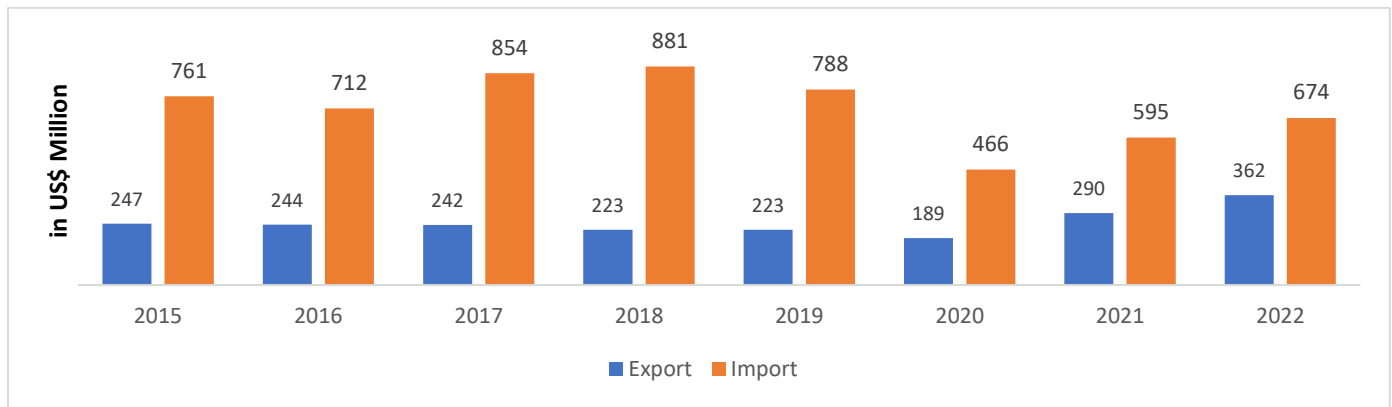

Source – ITC Trade Map and Technopak Analysis, HS Code: 8539, 9405

Key Risks and Challenges

- **Fluctuation in currency exchange rate**

Indian manufacturers are largely dependent on imports for sourcing LED manufacturing components and therefore fluctuation in rupee-dollar exchange rate is a concerning factor for the industry. These imported raw materials when exposed to exchange rate fluctuation, may result in abrupt increase in overall cost, thereby impacting the margin of the players.

- **Increasing competition**

Several companies have entered the lighting market with similar offerings at a cheaper price thereby, reducing the profit margins. Additionally, the industry faces intense competition from Chinese imports present in the domestic market with low quality products, resulting in low margins for the local manufacturers.

- **Increase in GST Rates**

GST rates on LED lights and components have increased from 12% to 18% in Fiscal 2022, which is expected to result in an increase in the price of LED lights and components and that will likely need to be absorbed by the consumers or the players or by both of them.

Section 6: Switch and Switchgear Market in India

Industry Overview

- **Switch and Switchgear Market Size**

Switches and switchgears are one of the most important components in the consumer electrical industry. Switches are used to control the electric circuits through “on” and “off” functionality. Switchgears are a centralized collection of circuit breakers and fuses to clear faults in the system, thus ensuring reliable power supply.

The total market size of switch and switchgears industry in India was collectively estimated at approximately ₹ 29,160 crore in Fiscal 2023. This has grown at a CAGR of approximately 8% from Fiscal 2015, when its size was at ₹ 15,500 crore. Going forward, the collective market (of switches and switchgears) is expected to grow at a CAGR of approximately 7% till Fiscal 2027 and reach approximately ₹ 38,000 crore of annual sales in Fiscal 2027. Switches and Switchgears by virtue of their distinct functionalities are two distinct sub-segments that make up the whole category. The pecking order of key players and the competitive intensity, the products on offer and the stock keeping units (“SKUs”) mix are distinct for these two categories. For instance, while leading players have a share of 57% of the total sales in the switches category, they only have a corresponding 27% share of total sales in the switchgears category. At a collective level, both these categories have witnessed a similar growth trajectory in between Fiscal 2015 and 2023 and these categories are expected to grow at a similar level in the next four years (Fiscal 2023-Fiscal 2027).

Exhibit 6.1: Indian Switch and Switchgear Market – By Value (₹ Cr) in Fiscal Year

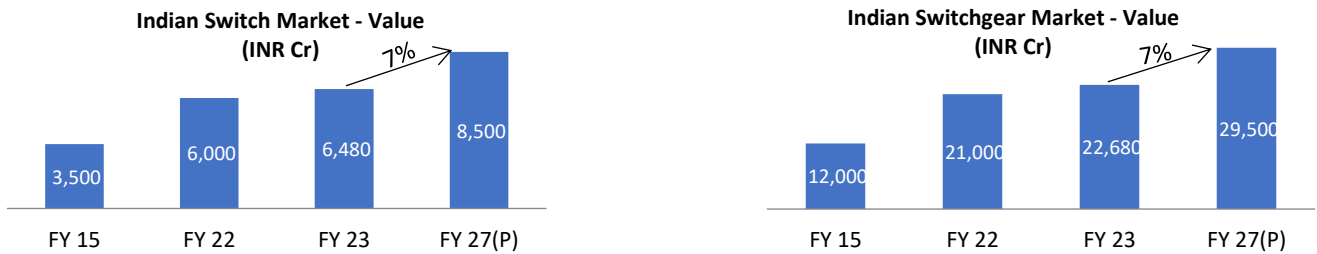

Source – Secondary research, Technopak Analysis; Note-This does not include exports.

Key segments of Switch and Switchgear market

The switch industry consists of two key segments - traditional and modular switches. 38% of the switch market is made up of traditional switches and the balance 62% of the market comprises modular switches in value terms. Modular switches are four to five times more expensive than traditional switches and thus, hold a higher share in the market by value.

The switchgear industry consist of three key segments - low voltage (“LV”), medium voltage (“MV”) and high voltage (“HV”). The LV switchgear market is largely formed by product use cases in residential and commercial real estate sectors. The MV and HV switchgears are largely deployed in industries and power utilities. LV switchgear market accounts for approximately 71% of the total switchgear and the balance 29% of the market is made up of MV and HV put together as in Fiscal 2023. This structure is expected to continue in the future.

Exhibit 6.2: Breakup of different segments of Switch and Switchgear Market in India – By Value (₹ Cr) in Fiscal Year

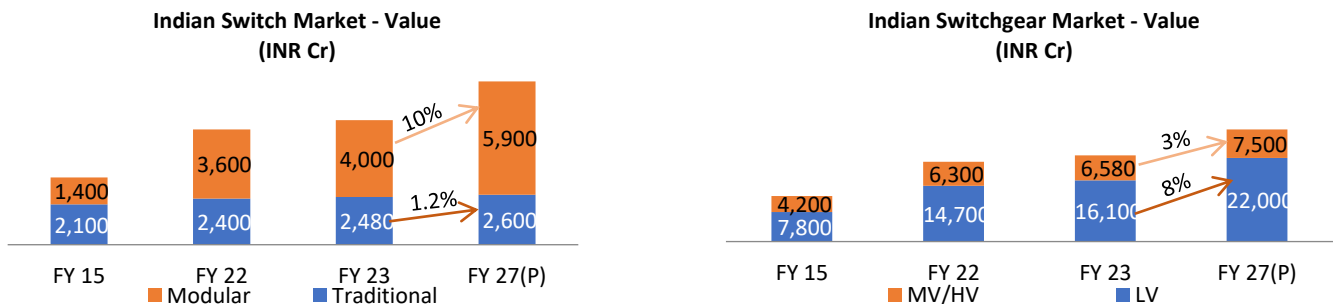

Source – Secondary research, Technopak Analysis

Given the nature of demand of LV switchgears due to high consumer connect and a retail led selling and distribution channel, LV switchgears' market structure (dynamics, value chain, retailing approaches) is more similar to that of switches than to the MV/HV switchgears, which pivots to B2B industrial market structure.

Trends shaping the Switch and Switchgear Market

- **Shift towards branded play**

Between Fiscal 2015-2023, the Indian switch and switchgear market has further consolidated towards branded players. It increased from 65% in Fiscal 2015 to 82% in Fiscal 2023. This is further expected to consolidate to 90% by Fiscal 2027.

Exhibit 6.3: Share of branded players Vs Unbranded players in Indian Switch and Switchgear Market-By Value in FY

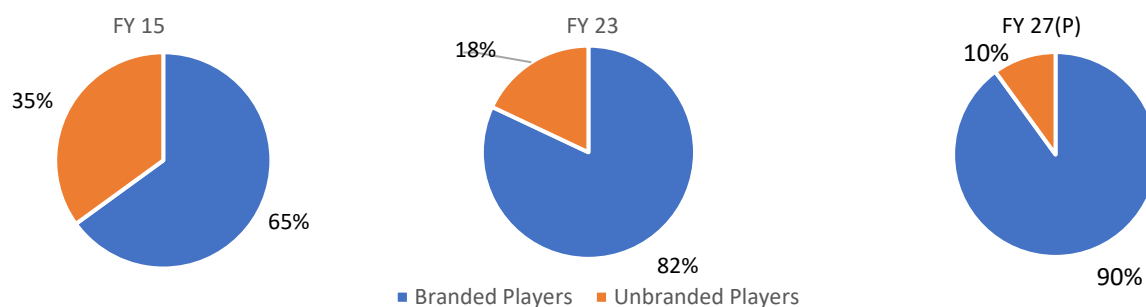

Source – Secondary research, Technopak Analysis

Apart from the awareness among consumers to seek safety and quality and advent of GST regime, this consolidation of branded play of the switch and switchgear market over unbranded play is driven by following key factors:

- **Need for high end technological intensiveness:** The switch and switchgear industry require high end technological intensiveness which is designed with the consideration to reduce hazard to human life, loss of electricity services and economic losses due to short circuits and power outages. This requires technical know-how, certifications and licenses which unbranded players generally lack, thus making it favorable for branded players. In recent times, with increasing appreciation for devices and digital connected homes and offices that require uninterrupted and safe supply of electricity, this requirement has graduated from a discretionary choice to a common minimum demanded from the customers.
- **Safety standards laid by Central Electricity Authority of India (“CEA”):** The Central Electricity Authority Regulations, 2022 has proposed various measures relating to safety and electric supply such as training of workers and assistance of supervisors which are applicable to all electrical installation and persons engaged in related activities. These measures are actively taken care of by the branded players at the time of manufacturing of their products and during their installations. Thus, a branded player has become a proxy for reliable and functional aspects over an unbranded player.

Key Growth Drivers

Apart from growth drivers impacting the electrical consumer market like rural electrification, increase in retail, commercial and residential establishments, increase in renewable energy-based capacity and various policy interventions by GoI to boost production, exports and promote ease of doing business, there are a few sector specific growth drivers of the switches and switchgear market.

Integration of smart monitoring and control units across power grid infrastructure

The growing implementation of smart grids and smart meters across India for accurate billing and reducing fraud and technical losses has resulted in the implementation of smart power distribution devices such as smart switchgears. Smart switchgears are flexible, energy-efficient, ensures increased performance, power continuity, and resource optimization, while lowering the transmission, operational and maintenance costs. Therefore, several developments in the power distribution sector along with infrastructure development schemes by GoI are expected to positively influence the switchgear market in India.

- **Replacement Demand**

The upgradation of aging power infrastructure to reduce the power blackouts have created a potential opportunity for the growth of switchgear market. The primary reason behind power blackouts is the lack of investments, aging infrastructure and improper regulations for modernization of the grid. However, the increasing energy demand has led to the need for a reliable and stable

transmission and distribution network, leading to adoption of new regulations to lessen power cuts and upgradation of power infrastructure. Further, the replacement of traditional switches with the modular switches to ensure safety in old construction and increasing demand for new construction is likely to provide impetus to the switch market in India.

Key Players in the Industry

The leading players in the switch industry include Anchor (Panasonic), Legrand followed by Havells. Anchor (Panasonic) and Legrand lead the Indian switch market with a combined share of approximately 60% of the market by value in Fiscal 2023. RR Kabel, a recent entrant in the segment contributes less than 1% to the total switch market by value in Fiscal 2023. Leading players in the switchgear industry include ABB, Siemens followed by Havells and Schneider. ABB and Siemens are leaders in Indian switchgear market with a combined share of approximately 28% of the market by value in Fiscal 2023.

Exhibit 6.4: Market share of players in Domestic Switch and Switchgear Industry in India - by Value in Fiscal 2023



Source – Secondary Research and Technopak Analysis

Exhibit 6.5: Key players in the Switches and Switchgear Industry

Sub-Category	Switches	Low Voltage Switchgear	Medium Voltage/High Voltage Switchgear
Leading Players	Anchor (Panasonic)	Legrand	ABB Ltd.
	Legrand	Havells	Siemens
	Schneider (L&T)	Schneider (L&T)	Havells
	-	Siemens (C&S Electric Ltd.)	-
	-	ABB Ltd.	-
Challenger Brands (Other Key and Small players)	Havells	Hager	BHEL
	GM Modular	Polycab	Schneider (L&T)
	RR Kabel	RR Kabel	-

Source – Secondary Research and Technopak Analysis

Basis the operating price points, the switch market has been categorized into three price segments namely economy, standard, and premium.

Exhibit 6.6: Price segmentation of Switch Industry

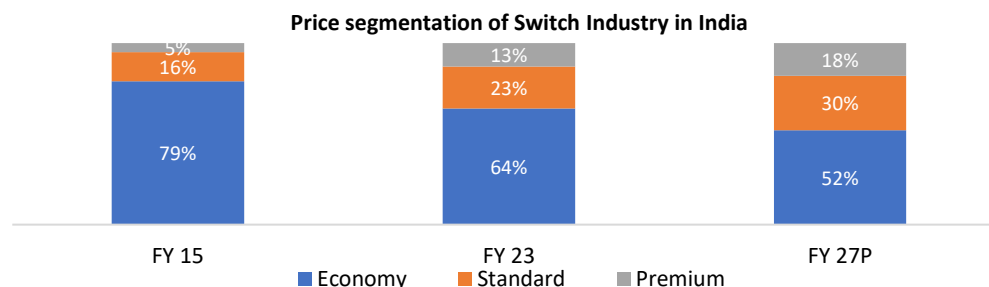

Source – Secondary research and Technopak Analysis

Note – Economy - <₹ 40, Standard – ₹ 40-70, Premium - >₹ 70

The switch industry in India is steadily shifting away from the economy segment. The non-economy segment (standard and premium put together) made up 21% of the total market in Fiscal 2015. This has increased to 36% in Fiscal 2023 and is expected to grow to 48% in Fiscal 2027. Increase in disposable income, consumer awareness and consumer demand for design, functionality and superior performance have resulted in increased demand for technologically advanced and aesthetically

designed switch products. These factors have enabled this market shift between Fiscal 2015-2023. Due to these factors, leading and challenger players in the switch industry have pursued new launches in the premium category of switches as a key growth enabler.

Sales Channels

Exhibit 6.7: Sales of Switch and LV Switchgear across retail channel (Fiscal Year)

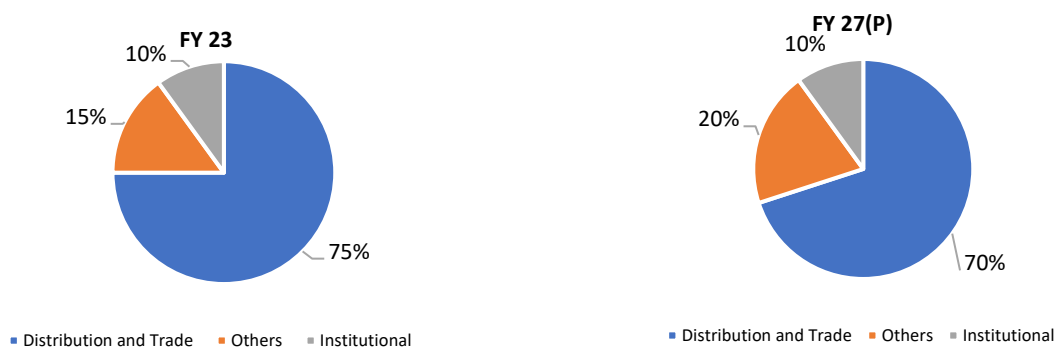

Note: Others include modern trade and ecommerce; Source – Secondary research and Technopak Analysis

Exports & Imports of Switches and Switchgears

India exported approximately US\$ 1,262 million worth of switches and switchgears in CY 2022. Exports were primarily to USA constituting approximately 20% of exports followed by Germany (6%) and Singapore (5%). Approximately US\$ 2,414 million worth of switches and switchgears products were imported from across the globe by India in CY 2022, wherein China accounted for approximately 27% of the imports. ABB Ltd., Siemens and Havells are some of the leading brands that export switchgears from India.

Exhibit 6.8: Export and Import of Switches and Switchgears (US\$ million)

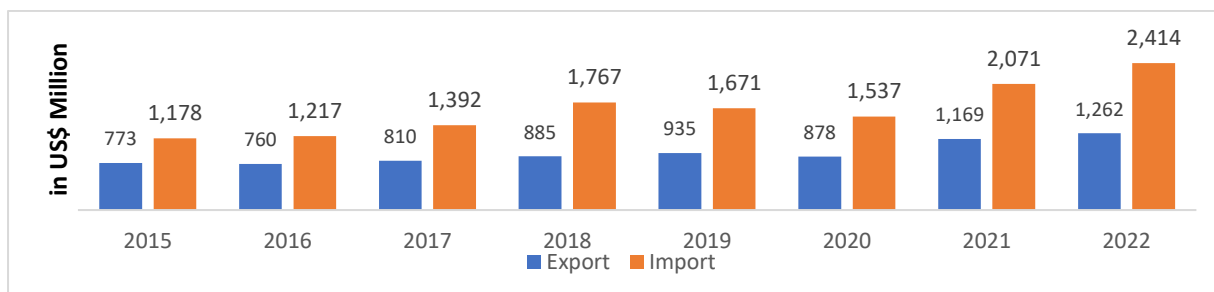

Source – ITC Trade Map and Technopak Analysis, HS Code: 8535, 8536

Section 7: Competitive Landscape

Several fundamental and long-term macro drivers and opportunities such as rising demand in housing and offices have influenced the consumer electrical industry’s growth and evolution. Other factors include electrification of rural villages, investments in transmission and distribution systems, increasing efficiencies, increasing demand for renewable power generation including solar and wind energy etc. Players have evolved from B2B sales to fast growing B2C brands with the emergence of the rapidly growing category of FMEG products. B2C sales provide a higher gross margin as compared to B2B sales. Leading players in consumer electrical industry like RR Kabel generate more than 74% of its revenue through B2C sales channel as of Fiscal 2023.

- Certifications and R&D expenditure**

ISO certifications are a must-have for organizations emphasizing on the mark on quality and credibility for any company. ISO protocols help companies in many different areas of the manufacturing and customer satisfaction process. RR Kabel is the first company in India to be REACH compliant which is the European standard to provide for a high level of protection to human health and the environment from the use of chemicals. Its products have 35 international product certifications, which is one of the highest in number among the peers in the Indian consumer electrical segment as of Fiscal 2023.

Research and development is an important aspect for the continual growth of the wires and cables and FMEG industry. With the manufacturing of technology driven products and implementation of industry 4.0, Indian companies are competing in the international market. With the increasing level of automation and inclusion of concepts like IoT, Artificial Intelligence (AI) and Machine Learning (ML), there has been a positive growth impact on the Indian FMEG Industry.

Exhibit 7.1: Certifications of key players

Players	Certifications
RR Kabel	ISO 9001, 14001, 45001, BASEC (UK), UL (USA), CSA (Canada), VDE (Germany), Intertek, CE (Europe) and TUV Rheinland (Germany), REACH (Europe), RoHS (Europe), CPR (Europe)
Finolex Cables	ISO 9001, 14001, 14000
Polycab	ISO 9001, 14001, OHSAS 18001
KEI Industries	ISO 9001, 14001, 45001, 17025, NABL, Achilles UVDB, CEOC, KEMANGCP, DNV-TAE00003U5, DNV-TAE00003U6, DNV-TAE00003U7, DNV-TAE00003U8
Havells	ISO 9001, 14001, 45001, 50001, OHSAS 18001
Bajaj Electricals	SABS, SASO, UL (USA), SIRIM, SLS, KBS, SONCAP, CE (Europe), ESMA, KUCAS, ISO 27001, 10002, 9001, 14001, OHSAS 18001
Crompton	ISO 9001, 14001, 45001
V-Guard	ISO 21702, 9001, 14001, 694, 12615, 8472, OHSAS 18001, JIS Z 2801, QCFI-JUSE, BIS

Source: Annual Reports, Secondary Research, NA- Not Available

- **Marketing Activities and Network of Influencers**

To enhance the brands' positioning as B2C players over the years, companies have consistently invested in brand building and advertisements including Above-the-Line (ATL) and Below-the-Line (BTL) marketing. Players like RR Kabel spend 60% of its marketing expenditure on BTL activities in rural and urban areas, while the remaining 40% are spent on the ATL activities including partnering with a leading Indian Bollywood actor as brand ambassador and sponsoring Bengaluru Pro Kabaddi Team in 2019 and KKR in 2021. The marketing activities carried out by the companies in the consumer electrical industry is taking mindshare of buyers willing to invest in upgradation of their spaces and lifestyles. Brands are offering new combo deals, unique discounts and products along with their enhanced presence on online and offline platforms.

Exhibit 7.2: Marketing activities and yield (as % of revenue)

Players	Marketing Yield				Marketing expenses (Fiscal 2023) (₹ Crore)	Marketing expenses for last 3 years (Fiscal 2021-2023) (₹ Crore)	ATL	BTL	Digital
	Fiscal 2021	Fiscal 2022	Fiscal 2023	3-year average marketing yield (Fiscals 2021-2023)					
RR Kabel	1.0%	1.1%	1.5%	1.3%	85	160	□	□	□
Finolex Cables	0.5%	0.3%	NA	0.4%*	NA	23*	□	□	□
Polycab	0.8%	0.7%	0.9%	0.8%	124	275	□	□	□
KEI Industries	0.3%	0.5%	0.3%	0.4%	22	62	□	□	□
Havells	1.6%	1.8%	2.6%	2.1%	437	851	□	□	□

Bajaj Electricals	4.7%	4.8%	6.5%	5.4%	353	801	□	□	□
Crompton	1.7%	1.7%	3.0%	2.2%	206	378	□	□	□
V-Guard	1.0%	1.6%	2.2%	1.7%	89	175	□	□	□

Source: Annual Reports, Secondary Research, NA- Not Available; Marketing yield= Marketing expenses/ Revenue from Operations

*Marketing expense for Finolex Cables in Fiscal 2023 is not available. The given figures are of two fiscal years i.e., Fiscal 2021 and 2022.

With respect to the marketing yield of key players in wires and cables segment, RR Kabel has a 3-year average investment in marketing of 1.3% of the total revenue, as opposed to 0.6% of the total revenue in case of its wires and cables peers (Finolex Cables, Polycab and KEI Industries).

The marketing approaches adopted by the companies in recent times have been aimed at positioning their brands as a trusted brand in terms of quality, price and transparency. Companies have carried out marketing campaigns for brand building. Brand equity is being built through Digital Marketing, TV Commercials, Celebrity Endorsements etc.

Channels for Marketing Approaches

- **Television** – It is the most expensive medium, but it also offers the largest audience reach. Companies in consumer electrical industry use this medium, both to build basic customer awareness and to announce upcoming promotions and products. They run their ads during festivals such as Diwali and occasions such as cricket matches.
- **Celebrity Endorsement:** Companies are using popular celebrity endorsements for brand building by roping in celebrity ambassadors aligned with their price positioning, customer presence and national focus.
- **Digital Media** - Use of digital media as a marketing tool has been adopted by all key players over the years. The wider reach and relatively lower cost of customer conversion in digital media makes it a medium of choice. Adoption of social media channels such as Instagram, Twitter and Facebook by the youth has given an opportunity for brands to reach consumers directly through targeted campaigns. Exposure to content on television, OTT platforms, social media networking sites and other internet avenues are making consumers abreast with new products advancements and technology. This exposure is elevating consumer's enthusiasm for lifestyle products and leading them to reconfigure their choices of FMEG products, with different products for different occasions. RR Kabel has unique loyalty programs for retailers and electricians to ensure long term relations.
- **Print Media like Newspapers & Magazines** - This channel is used by many electrical products brands usually to inform customers about upcoming promotions and products with enhanced technology.
- **Key Partnerships and M&A over the years**

Acquisitions and mergers in the consumer electrical industry have an importance on the production capacity, products available, pricing and expansion. The acquisitions of Luminous Lights & Fans HEB and Arraystorm have helped RR Kabel to enter into the premium segment of the FMEG category, mainly in fans and lights. Mergers and acquisitions help companies in many ways including backward integration, cost efficiency, production efficiency, improved R&D, economies of scale and scope. The production of copper rods, glass fibers and other raw materials enables companies to provide superior product quality and ensures the availability of raw material.

Exhibit 7.3: Key Partnerships and M&A by players in Electrical Segment

Players	Key Acquisitions	Expansion	CY
RR Kabel	Home-electrical division of Luminous from Schneider Electric	Lights & Fans	2022
	Acquired Arraystorm from Kores (India)	LED Lights	2020
	Ram Ratna Electricals Limited	FMEG	2019
Finolex Cables	Alpha Rubber Co.	Wires & Cables	1972
Polycab	Silvan Innovation Labs	IoT bases home automation	2021
	JV with Techno		NA
	JV with Trafigura	Copper Wire Rod	2005
KEI Industries	-		-
Havells	Promptec Renewable Energy Solutions	LED & Solar lighting	2015
	My Lloyd	Air Conditioners	2017
Bajaj Electricals	Nirlep Appliances Pvt Ltd	Home Appliances	2021
	Starlight Lighting	CFLs & LEDs	2021
	Trilux Lenze	Luminaires	2005
Crompton	Butterfly Gandhimathi Appliances	Kitchen Appliances	2022
V-Guard	Simon Electric Pvt Ltd	Switches & Switchgears, Fan regulators, home automation	2021

Source: Annual Reports, Secondary Research, NA- Not Available

- **Manufacturing capabilities**

Companies have enhanced their market journeys with their state-of-the-art manufacturing facilities. Companies have also been tapping into the potential of their manufacturing capacities on the back of increasing government initiatives such as Indian Electrical Equipment Industry Mission Plan (2021-22). Under the Make in India scheme, the government is planning to establish consumer electrical industry clusters along with strong infrastructure. Through increasing roadways and highways projects, airports, power transmission and solar power projects, the government is planning to spur the infrastructure and construction activities. The Production Linked Incentive (PLI) Scheme is expected to further encourage private players to enhance their domestic manufacturing capabilities.

The Waghodia manufacturing facility for RR Kabel is one of the largest consumer electrical manufacturing facilities in India as of Fiscal 2023, with annual manufacturing capacity of 2.1 million core kilometres (CKM) of wires and cables. The manufacturing facilities are subjected to rigorous quality control checks, accreditation requirements and periodic inspections from various regulatory agencies who issue the product certifications. As a result of RR Kabel's focus on quality in manufacturing, certain products at its Waghodia facility have over 30 global accreditations and registrations, including from BASEC, UL, CSA, VDE, Intertek, TUV Rheinland and BIS.

Exhibit 7.4: Manufacturing facilities of key players and production capacity

Players	Manufacturing Facilities	Category	Units	Capacity per annum (FY 23)
RR Kabel	Waghodia, Silvassa, Roorkee, Gagret, Bangalore	Fans	Mn	3.15
		Switches & Switchgears	Mn	8.9
		Wires & Cables	Mn CKM	4.1
		PVC	MT	53,600
		Lights	Mn	1.9
Finolex Cables	Roorkee, Urse, Pimpri, Verna, Ponda	Wires & Cables	-	NA
		Switches & Switchgears	-	NA
		Copper Rods	-	NA
Polycab	25 manufacturing facilities across Halol & Daman (W&C, Fans, Switches), Roorkee (Fans), Nashik (Switchgears)	Wires & Cables	Mn Kms	5.4
		Switches	Mn	12
		Switchgears	Mn	12
		Fans	Mn	10.2
KEI Industries	Bhiwadi, Chopanki, Pathredi, Rakholi, Chinchpada	Cables	Mn Kms	0.125
		House Wires	Mn Kms	1.3
		Communication Cables	Kms	28,800
		Stainless Steel Wire	MT	9000
Havells	Alwar, Baddi, Faridabad, Haridwar, Neemrana, Sahibabad, Ghiloth	Wires & Cables	-	NA
		Switches & switchgears	-	NA
		Lightings	-	NA
		Fans	-	NA
		AC	Mn (Units)	2
		Bulbs	-	NA
		Panel Lights	-	NA
Industrial Lights	-	NA		
Bajaj Electricals	Ranjangaon, Chakan, Nashik, Aurangabad	Fans	Mn	2.7
		LED	Mn	0.8
		Starlite Lighting	Mn	11.8
Crompton	Goa, Vadodra, Ahmednagar, Baddi (Himachal Pradesh), Chennai (Butterfly)	Lightings	Mn	98.4
		Fans	Mn	10.4
V-Guard	Coimatore, Kashipur, Kala Amb, Perundai, Roorkee, Sikkim, Haridwar	Fans	-	NA
		Wires & Cables	-	NA
		Switches & Switchgears	-	NA

Source: Annual Reports, Secondary Research, NA- Not Available,

Note: data based on Fiscal 2022

- **Distribution and retail network**

The manufacturers of wires and cables and FMEG products have also increased their share in retail sales over the past few years. With the objective of penetrating further into the markets and enhancing the presence of the brands across new territories, companies have expanded their distribution network to tier II and tier III cities. RR Kabel has one of the highest number of

distributors servicing the extensive retail footprint in consumer electrical industry as on March 31, 2023, and has increased its retailer outlets by 3.5x from 30,570 in Fiscal 2021 to 1,06,626 in Fiscal 2023, pursuant to its undertaking of certain initiatives like Lakshya and KaRRma. The count of their retailer outlets has further increased to 1,14,851 as on 30th June 2023.

Exhibit 7.5: Distribution & Retail Touch Points of Key Players (Fiscal Year)

Players	Dealers/ Distributors (Fiscal 2021)	Dealers/ Distributors (Fiscal 2023)	Retails Outlets (Fiscal 2021)	Retails Outlets (Fiscal 2023)
RR Kabel	4,233	6,740	30,570	1,06,626
Finolex Cables	5,000	5,000+	90,000	1,75,000
Polycab	4,100+	4,300+	1,65,000+	2,05,000+
KEI Industries	1,655	1,900+	NA	NA
Bajaj Electricals	500+	700+	2,18,000+	2,00,000+
Crompton	NA	4,000+	NA	1,50,000+
V-Guard	NA	NA	40,000+	60,000+

Source: Annual Reports, Secondary Research, NA- Not Available

- **FMEG vs. Wires & Cables**

The wires and cables industry are the largest part of the W&C and FMEG industry, accounting approximately 41% of the industry. At the same time, the FMEG industry has also evolved rapidly on the back of structural drivers such as changes in demography, consumer behavior, technology and rising disposable incomes. RR Kabel is one of the leading players in the W&C industry with approximately 89% of its revenue generated from the W&C segment and now has a fast-growing FMEG segment, post-acquisition of Luminous. Key players in the wires and cables industry are expanding into FMEG segment because of its high adjacency with established wires and cables segment. In Fiscal 2023, RR Kabel's revenue contribution from FMEG segment is approximately 11%, which is highest among its peers. This has continued to remain highest at 11% among peers even in first quarter of Fiscal 2024.

Exhibit 7.6: Wires & Cables and FMEG revenue breakup for key players in Fiscal 2023

Players	FMEG	W&C	Others
RR Kabel	11%	89%	-
Finolex Cables	4%	95%	1%
Polycab	9%	87%	4%
KEI Industries	-	92%	8%
Havells	42%	33%	25%
Bajaj Electricals	88%	-	12%
Crompton	100% (82% ECD & 18% Lighting)	-	-
V-Guard	30.9%*	43.6%*	25.5%

Source: Annual Reports, Secondary Research, NA- Not Available

*V-Guard's FMEG includes kitchen appliances and air coolers, and W&C includes pumps, switchgears and modular switches.

Exhibit 7.7: Revenue contribution from FMEG for key players in Wires and Cables Market

Players	Revenue contribution from FMEG (Fiscal 2021)	Revenue contribution from FMEG (Fiscal 2023)	Revenue contribution from FMEG (three months ended June 30, 2023)	CAGR (Fiscal 2021-23)
RR Kabel	7%	11%	11%	77%
Finolex Cables	4%	4%	4%	33%
Polycab	11.5%	9%	8%	11%
KEI Industries	0%	0%	0%	0

Source: Annual Reports, Investor Presentations Secondary Research

- **Export v. Domestic**

The Indian wires and cables industry exported products valued at approximately US\$ 1,717 million in CY 2022, to major export markets like USA, UAE, UK. The Indian fan industry exported products was valued at approximately US\$ 70 million in CY 2022, to major export markets like UAE and Nepal. The Government of India has delicensed the electrical machinery sector and allowed 100% FDI for growth of the industry. In Fiscal 2023, RR Kabel generated approximately 23% of its revenues from

exports of its products to 63 countries. As of CY 2022, RR Kabel is one of the leading exporter of wires and cables from India, in terms of value, representing an approximately 9% market share (pertaining to FY 23 revenue of RR Kabel) of the exports market from India.

The entry barriers in electrical products manufacturing industry includes economies of scale and scope, continuous R&D, capital-intensive production, production certifications and switching costs. The Indian government is providing various incentives under the Export Promotion Capital Goods scheme, Duty Remission scheme, Focus Product scheme etc. Other steps have been taken to bridge the skill gap required for critical manufacturing by setting up of Electrical Equipment Skill Development Council (EESDC).

Exhibit 7.8: Exports vs Domestic Market in Fiscal 2023

Players	Export Countries	Exports	Domestic
RR Kabel	63	23% (₹ 1,270 crore)	77%
Finolex Cables	USA and UAE	1%	99%
Polycab	70+	10%	90%
KEI Industries	60+	10% (693 crore)	90%
Havells	70+	3%	97%
Bajaj Electricals	40+	1%	99%
Crompton	31	1%	99%
V-Guard	-	0.1%	99.9%

Source: Annual Reports, Secondary Research, NA- Not Available

Section 8: Operational and Financial Benchmarking

Review of financial performance

1) Revenue from Operations

Revenue from operations is the top line parameter for a company's financials. Havells, Polycab and KEI Industries were the top three companies in terms of revenue generation in Fiscal 2023. RR Kabel is the fastest growing consumer electrical company among the peers in India, growing at a CAGR of 43.4% between Fiscal 2021 and Fiscal 2023.

Exhibit 8.1: Revenue from Operations in Fiscal Year (₹ Crore)

Company	2021	2022	2023	CAGR 2021-23
RR Kabel	2,724	4,386	5,599	43.4%
Finolex Cables	2,768	3,768	4,481	27.2%
Polycab	8,792	12,204	14,108	26.7%
KEI Ind	4,182	5,727	6,912	28.6%
Havells	10,457	13,938	16,911	27.2%
Bajaj Electricals	4,585	4,813	5,429	8.8%
Crompton	4,804	5,394	6,870	19.6%
V Guard	2,721	3,498	4,126	23.1%

Source: Technopak Analysis, Annual Reports

2) EBITDA and EBITDA margin

EBITDA and EBITDA margins is largely used to compare the profitability of the companies against competitors. It is also used to standardize the business performance against the industry averages. Polycab, KEI Industries and RR Kabel have registered the highest EBITDA CAGR of 27.0%, 24.2% and 19.0% respectively for the period Fiscal 2021 to Fiscal 2023.

Exhibit 8.2: EBITDA (₹ Crore) and EBITDA margin (%) profiles in Fiscal Year

Company	2021		2022		2023		Fiscal 2021-2023
	EBITDA	Margin	EBITDA	Margin	EBITDA	Margin	CAGR
RR Kabel	252	9.2%	350	7.9%	357	6.3%	19.0%
Finolex Cables	447	15.7%	500	13.0%	627	13.6%	18.4%
Polycab	1,230	13.8%	1,355	11.0%	1,985	13.9%	27.0%
KEI Ind	476	11.3%	603	10.5%	734	10.6%	24.2%
Havells	1,759	16.5%	1,908	13.5%	1,777	10.4%	0.5%
Bajaj Electricals	423	9.1%	292	6.0%	434	7.9%	1.2%
Crompton	796	16.3%	816	14.9%	837	12.1%	2.5%
V Guard	333	12.1%	351	10.0%	336	8.1%	0.5%

Source: Technopak Analysis, Annual Reports

Note: EBITDA Margin = EBITDA/ Total Income

Note: EBITDA = Profit Before Tax + Depreciation & Amortization + Finance Costs – Exceptional Items (if any)

Note: CAGR shown on basis of EBITDA value.

3) PAT and PAT margin

The profit after tax (PAT) and PAT margins are used to assess if a company's business is profitable after meeting the operating and overhead costs. The PAT margin is under pressure across all players in the industry. Finolex Cables registered the highest CAGR of 35.1% for PAT for the time period Fiscal 2021 to Fiscal 2023. RR Kabel registered a PAT CAGR of 18.7% during the same period.

Exhibit 8.3: PAT (₹ Crore) and PAT margin (%) profiles in Fiscal Year

Company	2021		2022		2023		Fiscal 2021-2023
	PAT	Margin	PAT	Margin	PAT	Margin	CAGR
RR Kabel	134	4.9%	210	4.7%	189	3.4%	18.6%
Finolex Cables	238	8.4%	272	7.1%	434	9.4%	35.1%
Polycab	841	9.4%	848	6.9%	1,292	9.1%	23.9%
KEI Ind	270	6.4%	376	6.5%	477	6.9%	33.1%

Havells	1,044	9.8%	1,196	8.5%	1,072	6.3%	1.3%
Bajaj Electricals	189	4.1%	124	2.5%	216	3.9%	7.0%
Crompton	617	12.6%	578	10.6%	476	6.9%	-12.1%
V Guard	202	7.4%	228	6.5%	189	4.6%	-3.2%

Source: Technopak Analysis, Annual Reports

Note: PAT Margin= PAT/ Total Income; PAT = Profit Before Tax – Tax Expenses

Note: CAGR shown on basis of PAT value, na(1)- can't be calculated due to negative numerator or denominator or both.

4) Return on Equity

Return on equity (ROE) is a function of profit after tax and shareholder's equity. A sustainable business and increasing ROE over time can indicate a good value generation ability for the shareholders. A negative ROE indicates negative profit earned by the business. Polycab had the highest ROE among industry peers in Fiscal 2023.

Exhibit 8.4: Return on Equity for key players (in Fiscal Year)

Company	Return on Equity		
	2021	2022	2023
RR Kabel	13.8%	18.3%	14.2%
Finolex Cables	7.4%	7.4%	10.5%
Polycab	19.5%	16.4%	21.1%
KEI Ind	16.4%	19.2%	20.2%
Havells	22.0%	21.4%	17.0%
Bajaj Electricals	12.9%	7.6%	12.0%
Crompton	36.3%	22.4%	15.0%
V Guard	18.2%	17.4%	12.5%

Source: Technopak Analysis, Annual Reports

ROE = PAT/Average Shareholder's Equity

5) Return on Capital Employed

Return on Capital Employed (ROCE) indicates a company's efficiency by measuring the profitability of the business after factoring in the capital used by the company to generate profits. ROCE is a good indicator of the company's performance over long periods. Irrespective of onset of COVID-19, the industry maintained its ROCE levels in Fiscal 2021 to Fiscal 2023. Crompton had the highest ROCE in the industry in Fiscal 2023.

Exhibit 8.5: Return on Capital Employed for key players (in Fiscal Year)

Company	2021	2022	2023
RR Kabel	13.4%	17.0%	15.3%
Finolex Cables	11.3%	11.0%	12.5%
Polycab	20.9%	20.4%	25.9%
KEI Ind	19.8%	22.0%	24.6%
Havells	33.0%	31.1%	26.5%
Bajaj Electricals	16.5%	16.2%	22.3%
Crompton	45.5%	37.7%	56.5%
V Guard	24.3%	21.6%	18.8%

Source: Technopak Analysis, Annual Reports

ROCE = EBIT/Average Capital Employed, Capital Employed= Tangible Net Worth + Deferred Tax Liabilities + Total Debt, Tangible Net Worth = Total Assets - Total Liabilities – Intangible Assets, Total Debt= Long Term Borrowings + Short Term Borrowings

6) Working Capital Cycle

The working capital cycle describes the number of days it takes for a company to convert its inventory into sales generating cash. The lower the working capital cycle, the more efficient the business is. Crompton had the lowest working capital cycle in Fiscal 2023.

Exhibit 8.6: Working Capital Cycle for key players (in Fiscal Year)

Company	2021	2022	2023
RR Kabel	108	88	75
Finolex Cables	114	81	64
Polycab	94	73	66
KEI Ind	101	102	97

Havells	56	49	45
Bajaj Electricals	131	89	52
Crompton	8	7	11
V Guard	80	85	88

Source: Technopak Analysis, Annual Reports

Working Capital Cycle = Trade Receivables days + Inventory days – Trade Payable days

OUR BUSINESS

Unless otherwise stated, references in this section to “we”, “our” or “us” (including in the context of any financial information) are to the Company along with its Joint Venture, on a consolidated basis. To obtain a complete understanding of our Company and business, prospective investors should read this section in conjunction with “Risk Factors”, “Industry Overview”, “Financial Information” and “Management’s Discussion and Analysis of Financial Condition and Results of Operations” beginning on pages 28, 139, 269 and 379, respectively as well as financial and other information contained in this Red Herring Prospectus as a whole. Additionally, please refer to “Definitions and Abbreviations” beginning on page 1 for definition of certain terms used in this section.

The industry information contained in this section is derived from the industry report titled “Consumer Electrical Industry in India” dated August 30, 2023, which is exclusively prepared for the purposes of the Offer and issued by Technopak and is commissioned and paid for by our Company (“**Technopak Report**”). Technopak was appointed on January 27, 2023. We commissioned and paid for the Technopak Report for the purposes of confirming our understanding of the industry specifically for the purposes of the Offer, as no report is publicly available which provides a comprehensive industry analysis, particularly for our Company’s products, that may be similar to the Technopak Report.

We have included certain non-GAAP financial measures and other performance indicators relating to our financial performance and business in this Red Herring Prospectus, each of which are supplemental measures of our performance and liquidity and are not required by, or presented in accordance with Ind AS, Indian GAAP, IFRS or U.S. GAAP. Such measures and indicators are not defined under Ind AS, IFRS or U.S. GAAP, and therefore, should not be viewed as substitutes for performance, liquidity or profitability measures under Ind AS, IFRS or U.S. GAAP. In addition, such measures and indicators are not standardized terms, and a direct comparison of these measures and indicators between companies may not be possible. Other companies may calculate these measures and indicators differently from us, limiting their usefulness as a comparative measure. Although such measures and indicators are not a measure of performance calculated in accordance with applicable accounting standards, our Company’s management believes that they are useful to an investor in evaluating us as they are widely used measures to evaluate a company’s operating performance.

Some of the information set out in this section, especially information with respect to our business plans and strategies, contain forward-looking statements that involve risks and uncertainties. You should read “Forward Looking Statements” beginning on page 27 for a discussion of the risks and uncertainties related to those statements and “Risk Factors” beginning on page 28 for a discussion of certain factors that may affect our business, financial condition or results of operations. Our actual results may differ materially from those expressed in or implied by these forward-looking statements.

Our financial year ends on March 31 of every year, so all references to a particular financial year are to the twelve month period ended March 31 of that year.

OVERVIEW

We are one of the leading companies in the Indian consumer electrical industry (comprising wires and cables and fast moving electrical goods (“**FMEG**”)), with an operating history of over 20 years in India. The Indian consumer electrical industry was estimated at ₹1,811.50 billion in Fiscal 2023 and is expected to grow at a compounded annual growth rate (“**CAGR**”) of 10% until Fiscal 2027 to reach a market value of approximately ₹2,665.00 billion. (Source: Technopak Report) We are one of the leading companies in the Indian consumer electrical industry on account of the following:

- We are the fastest growing consumer electrical company among our peers in India, growing at a CAGR of 43.4% between Fiscal 2021 and Fiscal 2023;
- We are the fifth largest player in the wires and cables market in India, representing approximately 5% market share by value as of March 31, 2023;
- We are the fifth largest player in branded wires and cables market in India, representing approximately 7% market share by value as of March 31, 2023 as compared to approximately 5% market share by value as of March 31, 2015;
- We had the highest revenue contribution from the business-to-consumer (“**B2C**”) sales channel in wires and cables with approximately 74% of revenue coming from the B2C sales channel as of March 31, 2023;
- In calendar year 2022, we were one of the leading exporter of wires and cables from India, in terms of value, representing approximately 9% market share of the exports market from India;
- We have one of the largest network of electricians, covering 271,264 electricians across India, as of March 31, 2023;

- In Fiscal 2023, our revenue contribution from FMEG segment is approximately 11%, which is highest among our peers. This has continued to remain the highest at 11% among our peers even in the three months ended June 30, 2023. For further details in relation to peer comparison, see “*Industry Overview – Competitive Landscape*” on page 181;
- We have one of the highest number of distributors servicing the extensive retail footprint in consumer electrical industry as on March 31, 2023 and have increased our retailer outlets by 3.5 times from 30,570 in Fiscal 2021 to 106,626 in Fiscal 2023, pursuant to undertaking several initiatives; and
- Our products have 35 international product certifications, which is one of the highest in number among our peers in the Indian consumer electrical industry as of March 31, 2023.

(Source: Technopak Report)

We sell products across two broad segments - (i) wires and cables including house wires, industrial wires, power cables and special cables; and (ii) FMEG including fans, lighting, switches and appliances. In three months ended June 30, 2023, (i) 71% of our revenue from operations from our wires and cables segment (of which all of our revenue from operations from our house wires products); and (ii) 97% of our revenue from operations from our FMEG segment, are from the B2C channel. Our product's end use determines whether the sale is through a business-to-business (“**B2B**”) or B2C channel. According to Technopak, B2C sales provide a higher gross margin as compared to B2B sales.

We undertake the manufacturing, marketing and sale of (i) our wires and cable products under our ‘RR Kabel’ brand, and (ii) a variety of consumer electrical products, including fans and lights under the ‘RR’ brand, which is licensed by us. We also manufacture, market and sell fans and lights under the ‘Luminous Fans and Lights’ brand, which is licensed by us. Our ‘RR Kabel’ brand has over 20 years of operating history, while the ‘RR’ and the ‘Luminous Fans and Lights’ brands, which are licensed by us, have over 7 years and over ten years of operating history, respectively. We have received several awards for our brand including Best Brand in Building Material and Fittings category at the ET Infra Focus Summit and Awards 2022; Marketing Campaign of the year 2018 award by ABP News Brand Excellence Award, and Power Brand India 2017 in “Industry Trendsetter” category. We also won the Pride of India Brands Award, 2022. For further details, see “*History and Certain Corporate Matters – Awards, accreditations and recognitions received by our Company*” on page 238.

Our wires and cables segment has been in operation since Fiscal 1999 and includes a wide range of products such as house wires, industrial wires, power cables and special cables. For further details in relation to our products, see “*–Description of our Business and Operations – Our Products*” on page 204. We were the first company in India to introduce low smoke zero halogen (“**LS0H**”) insulation technology in our wires and cables products, and to introduce unilay core technology (heat resistant and flame retardant) products. (Source: Technopak Report) For further details on the LS0H technology, see “*Industry Overview – Wires and Cables Market in India – Trends Shaping the Domestic Wires and Cables Market – New Technological Interventions*” on page 159. Our wires and cables segment contributed to 88.56% and 89.09% of our revenue from operations in Fiscal 2023 and three months ended June 30, 2023, respectively.

We have actively diversified and expanded our product portfolio in adjacent areas such as FMEG, both organically and inorganically. In Fiscal 2020, we amalgamated the business from one of our group companies, Ram Ratna Electricals Limited (“**RREL**”). In Fiscal 2020, we also acquired the light emitting diode (“**LED**”) lights and related hardware business (“**LED Lights Business**”) of Arraystorm Lighting Private Limited (“**Arraystorm**”), along with its trademarks and design certificates, to expand our portfolio to cover office, industrial and warehouse spaces. In May 2022, we acquired the corresponding home electrical business (“**HEB**”) of Luminous Power Technologies Private Limited (“**Luminous**”) and also obtained a limited and exclusive license to use the ‘Luminous Fans and Lights’ brand for fan and light products for an initial period of two years subject to extension of six months at a time for a maximum of four times and, that includes a right to use 61 registered trademarks, and a portfolio of lights and premium fans, to strengthen our FMEG portfolio. For further details, see “*History and Certain Corporate Matters – Details regarding material acquisitions or divestments of business/undertakings, mergers, amalgamation, any revaluation of assets, etc. in the last 10 years*” on page 238. We also started manufacturing switches in Fiscal 2021. We believe that this has enabled us to build a wide FMEG portfolio that benefits from our brand. According to Technopak, our FMEG portfolio covers approximately 77% of the FMEG industry by value in India as on March 31, 2023. Our FMEG segment contributed to 11.44% and 10.91% of our revenue from operations in Fiscal 2023 and three months ended June 30, 2023, respectively. For further details in relation to the synergies that we expect to realize from these acquisitions, see “*Strengths – Well-positioned for growth in FMEG segment*” on page 199.

Our global distribution footprint encompasses both domestic sales within India and export sales across the world:

- **Domestic:** We have an extensive pan-India distribution presence and as on June 30, 2023, we have 3,450 distributors, 3,656 dealers and 114,851 retailers, on a non-exclusive basis. As part of our distribution strategy, we strive to provide our end-users a seamless experience through several touchpoints. Distributors purchase products from us and on-sell our products to end-users through retailers. Dealers purchase products from us and either, directly or through retailers,

on-sell to end-users. The dealers, distributors and retailers, directly and indirectly, cover electricians. In addition, we have a focused approach to expand our geographical market share in India by identifying micro and nano markets. Micro markets are individual pin codes in urban towns (which are towns with a population of more than 0.3 million) and nano markets are particular localities within such pin codes. (Source: *Technopak Report*) As on June 30, 2023, we have 789 employees in our sales and marketing team, who manage and coordinate with distributors, dealers and retailers. We also have a presence on recognized e-commerce platforms. As on June 30, 2023, we have 21 warehouses across 17 states and union territories in India. We intend to consolidate our warehouses over time.

- **Exports:** We export our range of wires and cable products directly as well as through distributors across the world. During Fiscals 2021 to 2023 and three months ended June 30, 2023, we sold our products to 63 countries in North America, APAC, Europe and Middle East. For the three months period ended June 30, 2023, 99% of our export revenue was derived from distributors, and 1% was derived from original equipment manufacturers (“**OEMs**”). We export majority of our products under our brand ‘RR Kabel’ and manufacture under private labels for select customers. We have long-standing relationships with 10 distributors in these markets who cover the majority of our exports. Revenue from outside India grew at a CAGR of 47.13% between Fiscals 2021 and 2023, and it contributes 26.94% of our revenue from operations for the three months period ended June 30, 2023.

We have a strong focus on innovation and research and development and have relied on innovation to differentiate our wires and cables and FMEG products. We were the first company in India to launch products compliant with the European regulations, such as Registration, Evaluation, Authorization and Restriction of Chemicals (“**REACH**”); Restriction of Hazardous Substances Directive (“**ROHS**”) and Construction Products Regulations (“**CPR**”). (Source: *Technopak Report*) As on June 30, 2023, we have a dedicated team of 60 employees focused on research and development, of which 22 employees exclusively work on research and development involving FMEG products. Further, we have a strong focus on quality, and our central quality and test laboratory for wires and cables in our facility at Waghodia, Gujarat (“**Waghodia Facility**”) is accredited by the National Accreditation Board for Testing and Calibration Laboratories (“**NABL**”) and as of June 30, 2023 is capable of performing 694 tests on our products. In addition, we have quality control departments at our remaining facilities for process monitoring, raw material testing and type testing of products. We also have a dedicated quality control department for quality testing of switches at our Waghodia Facility. Certain products manufactured at our Waghodia Facility have over 30 global accreditations and registrations, including from British Approvals Service for Cables (“**BASEC**”), Underwriters Laboratories (“**UL**”), Canadian Standards Association (“**CSA**”), Verband der Elektrotechnik (“**VDE**”), Intertek, Technischer Überwachungsverein (“**TUV**”) Rheinland and Bureau of Indian Standards (“**BIS**”). (Source: *Technopak Report*)

We own and operate two integrated manufacturing facilities which are located at Waghodia, Gujarat, being the Waghodia Facility, and Silvassa, Dadra and Nagar Haveli and Daman and Diu (“**Silvassa Facility**”) in India, which primarily carry out manufacturing operations in respect of wire and cables and switches. Additionally, we own and operate three integrated manufacturing facilities which are located at Roorkee, Uttarakhand (“**Roorkee Facility**”), Bengaluru, Karnataka (“**Bengaluru Facility**”) and Gagret, Himachal Pradesh (“**Gagret Facility**”) in India, which carry out manufacturing operations in respect of FMEG products. Our Waghodia Facility is one of the largest consumer electrical manufacturing facilities in India as of March 31, 2023, with an annual manufacturing capacity of 2.1 million CKM of wires and cables. (Source: *Technopak Report*) Our manufacturing facilities give us the in-house ability to manufacture 100% of our requirements for wires and cables and approximately 37% of our requirements for FMEG products by value. We purchase our balance requirements for FMEG products from third parties and eventually sell them as traded goods. For further details in relation to our manufacturing facilities and contract manufacturing, see “-Description of our Business and Operations – Manufacturing Facilities” and “-Description of our Business and Operations – Manufacturing Process” on pages 209 and 211, respectively.

Our efforts towards environmental, social and corporate governance compliance include promoting green energy, community development and conserving water. Our Waghodia and Silvassa Facilities have an installed rooftop capacity of 1.2 MW and 0.25 MW, respectively, for solar energy. Further, we purchase electricity from an offsite hybrid solar and wind plant with an installed capacity of 3.82 MW for our Waghodia Facility. These constitute 59% and 5% of the contracted demand for electricity for our Waghodia and Silvassa Facilities, respectively, as of June 30, 2023. For further details, see “-Description of our Business and Operations – Environmental, health and safety and sustainability initiatives” on page 225.

Over the years, we have received several leading awards and recognitions such as the All India Kaizen Competition 2021-2022 award in productivity.

The following table provides a snapshot of certain of our financial and operational performance indicators for the periods indicated:

Particulars	As at / for the Fiscal ended March 31,			Three months ended June 30,	
	2021	2022	2023	2022	2023
Revenue from operations (in ₹ million)	27,239.41	43,859.36	55,992.00	12,359.10	15,973.14
Profit for the year / period (in ₹ million)	1,353.98	2,139.37	1,898.72	181.42	743.48
Segment profit / (loss) before tax and interest (wires and cables) (in ₹ million)	2,268.87	3,227.22	3,515.83	461.88	1,246.44
Segment profit / (loss) before tax and interest (FMEG) (in ₹ million)	(300.64)	(298.41)	(695.30)	(148.78)	(169.53)
Revenue from operations growth (%)	-*	61.01%	27.66%	-*	29.24%
Profit after tax growth (%) ¹	-*	58.01%	(11.25%)	-*	309.81%
PAT Margin (%) ^{2#}	4.93%	4.83%	3.37%	1.46%	4.61%
EBITDA (in ₹ million) ^{3#}	2,532.40	3,537.27	3,577.04	471.82	1,298.99
EBITDA Margin (%) ^{4#}	9.22%	7.98%	6.35%	3.79%	8.05%
EBITDA Growth (%) [#]	-*	39.68%	1.12%	-*	175.31%
Return on Capital Employed (%) ^{5#}	13.59%	17.41%	15.57%	1.86%	5.95%
Return on Equity (%) ^{6#}	13.88%	18.63%	14.22%	1.43%	5.05%
Debt to Equity Ratio (times) ^{7#}	0.48	0.42	0.36	0.39	0.26
Fixed Asset Turnover ratio (times) ⁸	7.01	11.12	12.37	2.86	3.10
Wires and cables volume (MT)	37,139.00	45,629.00	54,571.00	11,380	15,559
Wires and cables volume growth (%)	-*	22.86%	19.60%	-*	36.72%

* Revenue from operations growth, wires and cables volume growth, EBITDA growth and profit after tax growth for Fiscal 2021 and three months ended June 30, 2023 has not been included as the comparative period has not been included in this Red Herring Prospectus.

1. Profit after tax is Profit for the period / year.
2. PAT Margin is calculated as Profit for the period / year divided by total income.
3. EBITDA is calculated as profit for the year/ period plus finance costs plus tax expense plus depreciation and amortization expense.
4. EBITDA Margin is calculated as EBITDA divided by total income.
5. Return on Capital Employed is calculated as Profit for the period/ year plus finance cost plus tax expenses (EBIT) divided by (Tangible Net Worth plus Total Debt plus Deferred Tax Liabilities). EBIT is not annualized. For reconciliation of Tangible Net Worth, see "Other Financial Information" on page 372.
6. Return on Equity is calculated as (Profit for the period/year less preference dividend) divided by average equity, profit for the period/year is not annualized.
7. Debt to Equity ratio is calculated as Total Debt divided by equity.
8. Fixed Asset Turnover ratio is calculated as Revenue from operations divided by average of (property, plant and equipment plus right of use assets).

**Average means (opening plus closing) divided by two.

***Growth is calculated as current period / year minus previous period / year divided by previous period/year.

****Total Debt is non-current borrowings plus current borrowings.

EBITDA, EBITDA Margin, EBITDA Growth, PAT Margin, Return on Capital Employed, Return on Equity and Debt to Equity Ratio are non-GAAP measures.

For reconciliation of non-GAAP measures, see "Other Financial Information – Reconciliation of Non-GAAP Measures" on page 372.

Our Promoters have extensive experience in the consumer electrical industry. TPG Asia VII SF Pte. Ltd. is our significant investor since Fiscal 2019. Our Promoter, Shreegopal Rameshwarlal Kabra won the Pride of India Honour at the Society Achievers Awards 2017 and 2022, and was the president of the Indian Electrical and Electronics Manufacturers' Association. Further, our Promoter, Kirtidevi Shreegopal Kabra was awarded the Savvy Women Empowerment Award in 2018. We also have a professional and experienced management team, consisting of our Key Managerial Personnel and Senior Management Personnel with experience in the consumer electrical business.

STRENGTHS

We believe that the following competitive strengths have positioned us to benefit from the market dynamics and capture expected growth in the Indian consumer electrical industry.

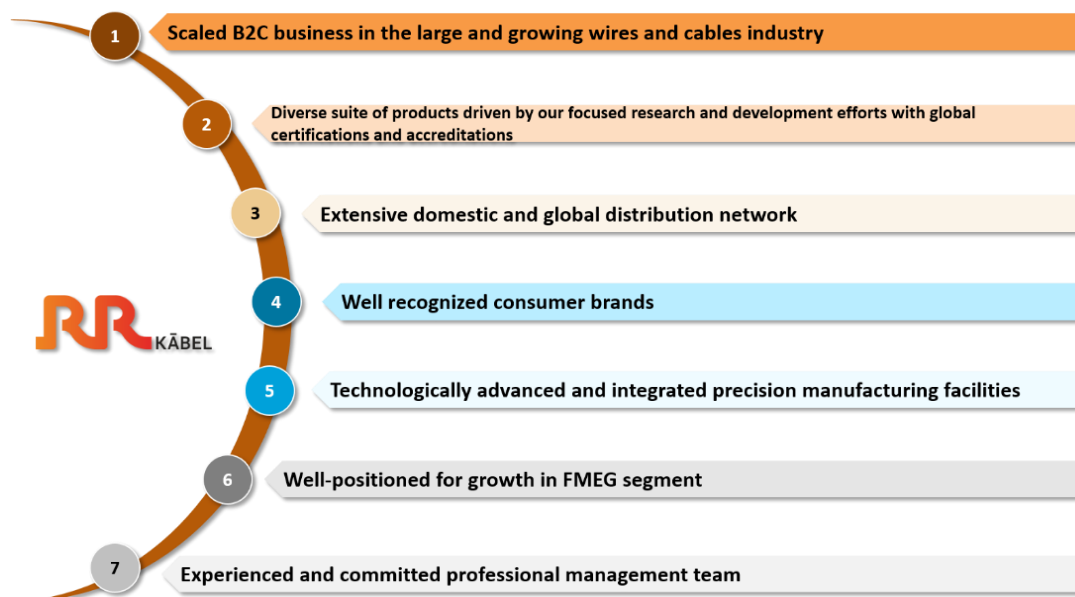

Scaled B2C business in the large and growing wires and cables industry

Wires and cables, primarily used for distribution and transmission of electrical power, are an important constituent, representing nearly 40% of the consumer electrical industry in India (comprising wires and cables and FMEG). (Source: Technopak Report) In Fiscal 2023, the total domestic market for wires and cables industry was estimated at ₹748.00 billion and is expected to grow at a CAGR of 13% until Fiscal 2027 to reach a market value of ₹1,200.00 billion. (Source: Technopak Report) As per Technopak, the trends shaping the wires and cables industry are, among other things, the shift towards branded play driven by rising awareness among consumers towards safety and quality, introduction of the goods and services tax (“GST”) regime, technological innovations by branded players and above the line focused brand building by branded players. The key growth drivers for the wires and cables industry in India include rural electrification, increase in per capita consumption of electricity in India, expansion in the residential and commercial real estate sector, transition towards clean and green energy, global shift from ‘China-based manufacturing’ to China plus one strategy and several government initiatives supporting infrastructure and housing such as ‘Housing for All’ scheme (Pradhan Mantri Awas Yojana). (Source: Technopak Report) The emergence of new age sectors such as the construction of Multimodal Logistics Parks (“MMLPs”) as a part of the Gati Shakti National Master Plan, local data centers and airports is expected to drive the increase in demand of wires and cables such as flexible cables, control and instrumentation cables etc. and FMEG products in India. (Source: Technopak Report) According to Technopak, the data center industry in India was valued at US\$4.4 billion in 2021 and is projected to reach US\$10.1 billion by 2027, growing at a CAGR of approximately 15% between 2022 and 2027, while the domestic electric vehicle market is estimated to see a 47% CAGR between 2022 and 2030.

We believe we are well-positioned to capture a significant share of this growth due to our existing market share, our brand recognition, diversified product portfolio, ability to innovate, our scale of operations, our sizeable and certified manufacturing facilities and infrastructure, quality and safety of our products and the reach of our distribution network. For further details in relation to our leadership position, see “-Overview” on page 190.

Diverse suite of products driven by our focused research and development efforts with global certifications and accreditations

Wires		Cables	
House Wires <ul style="list-style-type: none"> RR KABEL Heat Resistant Wires RR KABEL Fire Resistant Wires RR KABEL Flame Retardant Wires 		Power Cables <ul style="list-style-type: none"> RR KABEL LT Power Cable RR KABEL Medium & High Voltage Power Cables 	
Industrial Wires <ul style="list-style-type: none"> RR KABEL Single Core Flexible Cable RR KABEL Control Cables RR KABEL Submersible Flat Cable 		Specialty Cables <ul style="list-style-type: none"> RR KABEL Data & Communication Cables RR KABEL Instrumentation Cables RR KABEL Solar Cables RR KABEL Fire & Security Cables RR KABEL Silicon Rubber Cables RR KABEL Auto Cables RR KABEL Battery Cables RR KABEL Lift & Elevator Cables RR KABEL Appliance Wiring Material RR KABEL Power Cord 	
Applications (Infrastructure) <ul style="list-style-type: none"> Residential Commercial Public 		Applications <ul style="list-style-type: none"> Power Transmission Power Distribution 	
Applications <ul style="list-style-type: none"> Power Panels Control Panels Switchgears Relay Instrumentation Panels Control Panels Production & Assembly Lines Industrial Process Automation Plant Engineering Industrial Machinery Robotic Technology 			

Fans			Lighting	
Ceiling Fans	Table Pedestal & Wall Fans	Exhaust Fans		
Switch & Switchgear <ul style="list-style-type: none"> Modular Switches MCB Distribution Box 			Appliances <ul style="list-style-type: none"> Room Heater Water Heater Irons Cooler 	

We manufacture and sell a diverse portfolio of products across categories, giving us an opportunity to cross sell our products. Our products in the wires and cables segment include 'Firex LS0H', 'Superex', 'Unilay', medium and high voltage power cables and control cables. We also manufacture a range of special application cables that can be customized as per customer specifications. For instance, in Fiscal 2021, we began supplying ready-to-use cable harnesses to a large Swiss textile machinery manufacturer in India and providing this manufacturer an alternative product manufactured in India and substituting its import

of such products. In addition, our products in the FMEG segment are fans such as Jaipur Mahal fans, Audie fans and Droot fans, LED lights such as bulbs, battens, panels and street lights of different watts, as well as appliances such as Ardent and Calid. For a detailed description of our diversified portfolio, see “-Description of our Business and Operations – Our Products” on page 204. We have been investing in global trends and have built capabilities to cater to the growing demand for products such as cables used by telecom operators which rollout 5G capabilities, electric vehicle (“EV”) charging cables, smart fans and designer lights.

Since our incorporation as a B2C manufacturer of wires and cables, we have diversified into the FMEG segment and are transforming our company to a diversified consumer electrical company. According to Technopak, our FMEG products cover approximately 77% of the FMEG industry by value in India as on March 31, 2023. In particular, the success of our diverse portfolio of products has been driven by our focused research and development efforts, as well as the global certifications and accreditations awarded to them. As a result of our focus on quality in manufacturing, certain products manufactured at our Waghodia Facility have over 30 global accreditations and registrations, including from BASEC, UL, CSA, VDE, Intertek, TUV Rheinland and BIS. (Source: Technopak Report) As on June 30, 2023, we have a dedicated team of 60 employees focused on research and development, of which 22 employees exclusively work on research and development involving FMEG products.

During the three months ended June 30, 2023, we have launched 6 and 28 new products in the wires and cables and FMEG segments, respectively. Further, as of June 30, 2023, we have 15 and 55 products under development for wires and cables and FMEG segments, respectively, of which no products under wires and cables segment and 12 products under FMEG segment have been launched as of the date of this Red Herring Prospectus. For further details in relation to total number of products launched in Fiscals 2021, 2022 and 2023 and three months ended June 30, 2022 and June 30, 2023, see “-Description of our Business and Operations – Research and Development” on page 224.

Extensive domestic and global distribution network

Our distribution footprint encompasses both domestic sales and export sales, as follows:

- ***Domestic:*** We have an extensive pan-India distribution presence and as on June 30, 2023, we have 3,450 distributors, 3,656 dealers and 114,851 retailers. As part of our distribution strategy, we strive to provide our end-users a seamless experience through several touchpoints. Distributors purchase products from us and on-sell our products to end-users through retailers. Dealers purchase products from us and either, directly or through retailers, on-sell to end-users. The dealers, distributors and retailers, directly and indirectly, cover electricians. We have one of the largest network of electricians, covering 271,264 electricians across India, as of March 31, 2023. (Source: Technopak Report) Pursuant to several initiatives undertaken by us, we have increased our electrician network from 61,224 in Fiscal 2021 to 298,084 in the three months period ended June 30, 2023 and the number of our retailer outlets from 30,570 in Fiscal 2021 to 114,851 in the three months period ended June 30, 2023. For further details in relation to the increase in the total number of distributors, dealers, retailers and electricians and their geographical distribution over central, eastern, northern, southern and western regions of India over Fiscal 2021 to three months ended June 30, 2023, see “-Description of our Business and Operations – Sales and Marketing – Distribution” on page 213. We have long-standing relationships with many distributors and believe this provides us with a competitive edge.

As on June 30, 2023, we have 789 employees in our sales and marketing team, who manage and coordinate with distributors, dealers and retailers. We have also established an “Individual Bungalow team” in certain Metros and Tier I cities, to help identify new constructions of individual bungalows and contact the end-users. According to Technopak, Metro cities are Delhi National Capital Region and Mumbai, and Tier I cities are cities with a population between 1 million and 5 million. This enables us to be involved at all stages of the construction, i.e. from the construction phase when wires are installed until the final stage when switches and fans are purchased. Our acquisition of the HEB of ‘Luminous Fans and Lights’ HEB in May 2022 also gave us a presence on recognized e-commerce platforms.

To strengthen our distribution network, we have undertaken several initiatives. We launched an initiative ‘Project KaRRma’ in Fiscal 2020 in two phases to achieve a higher market share in housing wires by expanding retail outlets, electricians, sales force and product portfolio. We intend to double the market share and retail outreach in domestic house wires, by increasing our micro and nano market reach. We have carried out initiatives such as making connections with retail outlets through routine visits, launch of loyalty management programs for electricians as well as long term loyalty management programs for retailers. For further details of our loyalty management programs, see “-Description of our Business and Operations - Sales and Marketing” on page 213. We also launched another five-year long initiative ‘Project Lakshya’ in Fiscal 2020, comprising two phases beginning with an object to organically and inorganically grow our fans and lights product portfolio, and thereafter integrating the HEB of ‘Luminous Fans and Lights’ brand. We aim to integrate the Luminous HEB by enhancing synergies at the back and front end from manufacturing to sales, including by design integration and integration of functions, such as warehousing, logistics, procurement and sales integration.

From Fiscal 2021 to Fiscal 2022, and from Fiscal 2022 to Fiscal 2023, our revenue from operations from FMEG segment grew by 34.84% and 133.25%, respectively. Further, according to Technopak, electricians are key decision makers in the consumer electrical industry, and in respect of housing wires, form the major segment of customers in the value chain. We have implemented a partner loyalty program for retailers and electricians, including RR Connect's mobile phone application and web portal, and rewards schemes, such as RR Dosti 3.0 and Udaan 3.0. Our Kabel Star initiative further provides scholarships to the children of electricians who have registered on our RR Connect application. For further details, see “-Description of our Business and Operations – Sales and Marketing” on page 213.

As on June 30, 2023, we have 21 warehouses across 17 states and union territories in India. We intend to consolidate our warehouses over time. Our warehouses are strategically located to optimize our distribution by transport with the objective to achieve optimal balance between lead time to service and total distribution cost.

In addition, we have a focused approach to expand our geographical market share in India by identifying micro and nano markets for a specific product. For instance, for our 90 meters housing wires, we have classified our geographical presence in India into ‘winner’, ‘growing’ and ‘opportunity’ states. We classify ‘winner states’ as states where we have more than 9% market share by value, in Fiscal 2023 and three months ended June 30, 2023; ‘growing states’ as states where we have 5% to 8.9% market share by value, in Fiscal 2023 and three months ended June 30, 2023; and ‘opportunity states’ as states where we have less than 5% market share by value, in Fiscal 2023 and three months ended June 30, 2023. Over time, we intend to classify our geographical presence in the same manner for all of our products.

- *Exports:* We have extended our business strategy to export markets and focus on recurring B2C exports. In calendar year 2022, we were one of the leading exporter of wires and cables from India, in terms of value, representing approximately 9% market share of the exports market from India. (Source: Technopak Report) We export our range of wires and cable products directly as well as through distributors across the world. Our revenue from operations from outside India increased by a CAGR of 47.13% from ₹5,867.66 million in Fiscal 2021 to ₹12,701.90 million in Fiscal 2023 and from ₹3,436.30 million in three months ended June 30, 2022 to ₹4,303.73 million in three months ended June 30, 2023. During Fiscals 2021 to 2023 and three months ended June 30, 2023, we sold our products to 63 countries in North America, APAC, Europe and Middle East. In particular, we have increased our exports to well-regulated markets such as the United States. We increased our exports to the United States from 5.16% of our export revenue in Fiscal 2021 to 11.59% of our export revenue in three months ended June 30, 2023. For the three months period ended June 30, 2023, 99% of our export revenue was derived from distributors, and 1% was derived from OEMs. We believe our focus on quality and large range of global certifications enables us to have a wide global presence.

We sell the majority of our products under our brand ‘RR Kabel’ and manufacture under private labels for select customers and have long-standing relationships with 10 distributors in these markets who cover the majority of our exports. Revenue from outside India contributes 26.94% of our revenue from operations for the three months period ended June 30, 2023. We believe that we are well-positioned to benefit from the global shift from China-based manufacturing to China plus one strategy resulting in a share gain for Indian manufacturers in the global market. (Source: Technopak Report)

For further details in relation to our revenue split by geographical area, see “Management’s Discussion and Analysis of Financial Condition and Results of Operations-Segment Reporting” on page 388.

Well recognized consumer brands

We are the fastest growing consumer electrical company amongst our peers in India, growing at a CAGR of 43.4% between Fiscal 2021 and Fiscal 2023. (Source: Technopak Report)

We believe that our focus on safety, quality and continuous innovation, together with our distribution network, connect with electricians and our digital and physical marketing efforts have enabled us to develop brand recognition in the consumer electrical industry. We have invested in implementing brand initiatives, such as Kabel Nukkad and Kabel Mela, to enhance our brand visibility over the last few years. Our brand also provides us the opportunity to cross-sell our FMEG products to our wires and cables customers. Our marketing and sales efforts are spread across multiple touch points where customers discover our brands and product offerings, which create opportunities for cross-selling our products on the back of our brands’ focus on safety, quality and innovation. We have also mapped the distribution network of our wires and cables products, and identified and worked with distributors and retailers to carry our FMEG products. We believe our connections with electricians through incentive driven marketing provides us with a unique competitive advantage and ensures long-term stickiness. Please see “Our Business – Sales & Marketing” on page 213 for further details of our marketing initiatives. We focus on a strategic advertising

mix between outdoor advertising such as temples and police stations and advertising campaigns with a broad reach, namely, through print, television and sponsorships.

We have implemented digitized technology-enabled services to manage our partners. Our mobile application RR Connect has helped us to track user-wise tertiary sales and primarily incentivize them through initiatives such as loyalty tier upgrades and long-term reward bonus points.

We track the total registered and new users on our application periodically and have seen the total users increase as follows:

	Fiscal 2021	Fiscal 2022	Fiscal 2023	Three months ended June 30, 2023
New Users	35,171	86,586	123,454	26,820
Cumulative registered users	61,224	147,810	271,264	298,084

The following table sets forth the total number of cumulative registered active users that have scanned our products for the periods indicated:

	Fiscal 2021	Fiscal 2022	Fiscal 2023	Three months ended June 30, 2023
Active Users	48,719	96,531	157,928	175,479

Over Fiscals 2021, 2022 and 2023 and three months ended June 30, 2022 and June 30, 2023, we have spent ₹259.61 million, ₹491.29 million, ₹851.43 million, ₹134.45 million and ₹188.15 million, respectively, towards advertisement and business promotion expenses, constituting 0.95%, 1.12 %, 1.52%, 1.09% and 1.18% of our revenue from operations over the same period. This constitutes an overall advertisement and business promotion expenses of ₹1,790.48 million since Fiscal 2021 up to the three months ended June 30, 2023. We curate our advertising campaigns to spread awareness about choosing quality wires. We were also one of the brand sponsors for the Bengaluru Pro Kabaddi league and the Indian Premier League - Kolkata Knight Riders sports team.

Technologically advanced and integrated precision manufacturing facilities

We own and operate five integrated manufacturing facilities – Waghodia Facility, Silvassa Facility, Roorkee Facility, Bengaluru Facility and Gagret Facility, each located in India. These facilities are accredited to Indian and international standards, capable of precision manufacturing of our range of products. Our Waghodia Facility is one of the largest consumer electrical manufacturing facilities in India as of March 31, 2023, with an annual manufacturing capacity of 2.1 million CKM of wires and cables. (Source: Technopak Report) Our Waghodia and Silvassa Facilities have the capability to manufacture a wide variety of wire and cable products including house wires, industrial wires, power cables and special cables. Our manufacturing facilities give us the ability to manufacture 100% of our requirements for wires and cables in-house. The percentage of overall rejection for our wires and cables is low at 0.12% in three months ended June 30, 2023. For further details in relation to capacity and capacity utilization of our manufacturing facilities, see “-Description of our Business and Operations – Capacity and Capacity Utilization” on page 210.

The acquisition of HEB of ‘Luminous Fans and Lights’ in May 2022 allowed us to expand into the premium FMEG segment through our access to manufacturing capabilities for premium FMEG products. For our FMEG segment, we manufacture switches at our Waghodia Facility. Further, we manufacture fans at our Gagret Facility and both fans and certain of our professional and trade lighting products at our Roorkee Facility at low production costs. Our Gagret Facility has automated processes such as an automated varnish shop and usage of robotics in the assembly line. Our manufacturing facilities give us the ability to manufacture up to 37% of FMEG products (by value) in-house and given that they are premium products, manufacturing them in-house provides us with a competitive advantage as we can closely control quality and cost. Our capital expenditure from Fiscal 2021 to three months ended June 30, 2023 was ₹3,454.31 million. For further details in relation to the breakdown of our capital expenditure, see “Management’s Discussion and Analysis of Financial Condition and Results of Operations – Capital Expenditure” on page 398. Our Bengaluru Facility is a designer customizable lights factory combined with premium high finish design capabilities. We have the ability to manufacture lighting fixtures as per the plans and specifications of the end-user, including interior designers and architects. Our Gagret Facility has a design and in-house testing facility for measuring air delivery of fans and our Roorkee Facility has in-house testing facilities for LED fixtures, which enables us to launch new and improved designs and functionality periodically. For three months ended June 30, 2023, the overall defect percent for (i) our products manufactured by OEMs is 1.3%; and (ii) our products manufactured at our Gagret, Bengaluru and Roorkee Facilities is 0.5%, 0.1% and 1.9%, respectively, of raw material consumed.

Our manufacturing facilities are subjected to rigorous quality control checks, accreditation requirements, and periodic inspections from various regulatory agencies that have issued us product and system certifications. The accreditation of our products is an essential requirement for our products to be marketed and exported to various highly regulated jurisdictions. We are able to obtain these accreditations due to our stringent quality checks and focus on safety. In addition, our manufacturing facilities have obtained several certifications for compliance with quality standards. Further, we have a key focus on quality and safety. Our central quality and test laboratory for wires and cables at our Waghodia Facility, is accredited by NABL and as of June 30, 2023 is capable of performing 694 tests on our products. For further details, see “-Description of our Business and Operations – Quality control, process safety and regulatory inspections” on page 220.

In addition, we have quality control departments at our remaining facilities for raw material testing, process monitoring, and type testing of products. Further, we have a dedicated quality control department for quality testing of switches at our Waghodia Facility. We have also devoted resources to develop, protect and defend our intellectual property. For further details in relation to our intellectual property, see “-Description of our Business and Operations – Intellectual Property” on page 233.

Our manufacturing facilities and warehouses are strategically located to achieve shorter time to market, greater cost competitiveness (through close proximity to raw material suppliers) and responsiveness of our inventory positions to changes in portfolio market as a result of proximity, thereby allowing them to cater to domestic and international markets. We have also taken steps to ensure the risk of raw material is diversified with multiple suppliers and imports. In particular, we have backward integrated our manufacturing process by producing several key raw materials, polyvinyl chloride (“PVC”) compound, LS0H compound, cross-linked polythene (“XLPE”) compound and solar cable compound in-house at our Waghodia and Silvassa Facilities. We believe that our integrated business model brings us advantages over our competitors such as:

- ensuring quality control as PVC is important for insulation, and a key component for quality and fire safety for wires and cables;
- reduction of raw material costs and logistics cost as we produce PVC compound, LS0H compound, XLPE compound and solar cable compound; and
- reduction of reliance on external suppliers for PVC compound, LS0H compound, XLPE compound and solar cable compound, thereby helping to maintain a steady production of wires and cables.

In addition, we intend to start manufacturing other raw materials such as thermoset e-beamable LS0H compound in Fiscal 2024. As of the date of this Red Herring Prospectus, we have conducted various procedures to develop such manufacturing capabilities, including fine-tuning the formulation design, checking the commercial viability and selecting and procuring the raw materials.

Well-positioned for growth in FMEG segment

In Fiscal 2023, the total domestic market for FMEG industry was estimated at ₹1,063.50 billion, representing approximately 59% of the total wires and cable and FMEG industry. (Source: Technopak Report) This is expected to grow at a CAGR of 8% until Fiscal 2027 to reach a market value of approximately ₹1,465.00 billion, on account of the following:

- The fan market in India was estimated at ₹138.75 billion in Fiscal 2023, and is expected to grow at a CAGR of approximately 7% until Fiscal 2027 to reach a market value of ₹185.00 billion, driven in part by premiumization, shift towards branded play and increase in demand for replacement FMEG;
- The lighting market in India was estimated at ₹336.00 billion in Fiscal 2023, and is expected to grow at a CAGR of approximately 11% until Fiscal 2027 to reach ₹505.00 billion of annual sales, driven in part by premiumization and demand for replacement FMEG; and
- The switch and switchgear market in India was estimated at ₹291.60 billion in Fiscal 2023, and is expected to grow at a CAGR of approximately 7% until Fiscal 2027 to reach ₹380.00 billion of annual sales, driven in part by the integration of smart monitoring and control units across power grid infrastructure and demand for replacement FMEG.

(Source: Technopak Report)

We believe we are well-positioned to capture a significant share of this growth, as a result of our omni-channel presence covering both physical and digital sales, distribution network, our product portfolio which extends across various price points and our ability to identify product gaps in the segment. We have a wide portfolio of FMEG products including fans, lighting & switches and appliances such as room heaters, irons, water heaters and coolers, and which according to Technopak, covers approximately 77% of the FMEG industry by value in India as on March 31, 2023.

While we expand our product suite and market access to drive organic growth, we also pursue inorganic growth opportunities by acquiring businesses that help expand our FMEG product portfolio. In Fiscal 2020, we diversified into FMEG segment by amalgamating the business from one of our group companies, RREL. In Fiscal 2020, we also acquired LED Lights Business of Arraystorm to add professional lighting fixtures and LED lights to our portfolio thereby expanding our portfolio to cover office, industrial and warehouse spaces. Further, pursuant to our recent acquisition of the HEB of ‘Luminous Fans and Lights’ in May 2022, we added lights and premium and mid-premium fans thereby expanding our FMEG segment. This acquisition helped us add over 23,046 retailers at the time of acquisition, which contributed to the increase of segment revenue from operations from our FMEG segment from 6.26% in Fiscal 2022 to 10.91% in the three months ended June 30, 2023.

These acquisitions have helped us realize synergies through cost optimization as:

- Similar raw materials are required by wires and cables as well as FMEG. We believe that we will be able to enjoy economies of scale when we purchase raw materials in large quantities on a combined basis;
- We benefit from reduced logistics and transportation costs. We will carry multiple products and increase the volume of products transported, thus spreading the overhead costs over a greater number of products, as well as benefit from geographical overlap and common distribution network; and
- FMEG and wires and cable segment have a pan-India geographical demand.

We believe the acquisition of the Luminous HEB of ‘Luminous Fans and Lights’ and Arraystorm have given us the following advantages (i) improve our retail distribution with the addition of retailers; (ii) provide access to alternate channels such as e-commerce channels; (iii) expand our product portfolio across price points in the economy, mid-premium and premium segments; (iv) boost our research and development and ability to launch new and improved designs with automated manufacturing and design and in-house testing facilities; and (v) add energy efficient models to our fan product portfolio, as we added over 54 and 5 star rated models and 12 and 3 brushless direct current (“**BLDC**”) fans in Fiscal 2023 and the three months period ended June 30, 2023, respectively. We have licensed the ‘Luminous Fans and Lights’ brand for our premium FMEG products and subsequently, aim to develop and establish ‘RR Signature’ brand for our premium FMEG products in replacement of the ‘Luminous Fans and Lights’ brand by Fiscal 2024.

In addition to our acquisition of HEB of ‘Luminous Fans and Lights’ and Arraystorm, we stand to benefit from our brand’s recall, focus on engaging with electricians which serve a dual role as end consumers and influencers within the value chain, and combined digital and physical marketing efforts.

Experienced and committed professional management team

We have a professional and experienced management team, consisting of our Key Managerial Personnel and Senior Management Personnel with experience in the consumer electrical businesses. Our Chief Executive Officer was appointed in December 2022 and has extensive experience in the electrical industry. The leadership team is supported by experienced senior managers who have extensive industry knowledge and have been associated with us as well as with leading multinational companies in India and outside India. For further details, see “*Our Management*” on page 243.

Our Promoters are experienced in the consumer electrical industry. Further, we have TPG Asia VII SF Pte. Ltd. as our significant investor. Our management team has demonstrated its ability to develop and execute a focused strategy to grow our business including in emerging and developed markets, enabling us to strengthen our market position. We believe that a combination of our promoters, professional leadership team and our investor has provided us with a competitive advantage and enabled us to provide products that focus on quality and safety.

STRATEGIES

We intend to strengthen our position as one of the leading consumer electrical brands in India while also growing our international business at scale by implementing the following strategies:

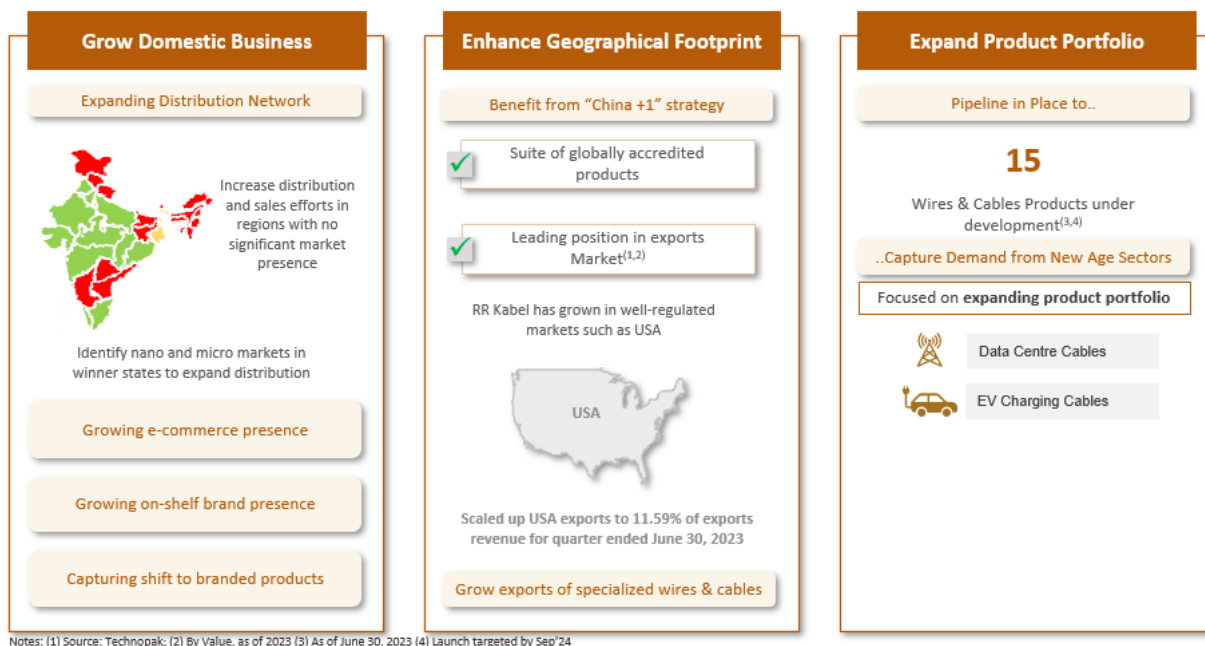

Expand distribution and establish leadership position for our wires and cables segment in India

We believe that by expanding our distribution network in India, we will benefit from greater connections and exposure to potential customers, thereby positioning ourselves to grow our market share in the domestic branded wires and cables and the general consumer electrical industry. For instance, we have classified our geographical presence in India into ‘winner’, ‘growing’ and ‘opportunity’ states for our 90 meters housing wires based on market share in these states. We have converted three ‘opportunity’ and ‘growing’ states into ‘winner’ states between Fiscal 2021 and three months ended June 30, 2023. Over time, we intend to classify our geographical presence in the same manner for all of our products. We also aim to consolidate and grow our business in India through various initiatives including, consolidating and growing our business in ‘winner’ states; and increasing our footprint and market share in ‘growing’ and ‘opportunity’ states. We have identified the geographical regions where we do not have a significant market presence and are increasing our distribution and sales efforts in these regions to grow our market share. In ‘winner’ states, we are identifying micro and nano markets, at the pin code (for districts, cities and villages) and taluka levels (for sub divisions of districts), within these regions to focus our distribution coverage, sales force coverage and marketing efforts. We are also growing our existing presence on e-commerce platforms to develop an omni-channel presence. We are expanding our product mix in our established markets to take advantage of the shift to branded play in these markets and changing consumer preferences for branded products that offer quality and safety features. We also intend to grow our on-shelf brand presence by expanding our existing offerings to “Star Dealers” (multi-brand outlets in high footfall areas) as well as independent retailers.

Enhance our geographical footprint of our wires and cables segment

In calendar year 2022, we were one of the leading exporter of wires and cables from India, in terms of value, representing approximately 9% market share of the exports market from India. (Source: Technopak Report) Leading players like us are well-positioned to benefit from the global shift from China-based manufacturing to China plus one strategy resulting in a share gain for Indian manufacturers in the global market. (Source: Technopak Report) We have also been focused on export markets for our wires and cable segment. We intend to leverage our suite of globally accredited products to grow our exports business. For example, we launched our products in the United States in Fiscal 2020 which has grown to 11.59% of our exports revenue for the three months ended June 30, 2023. We intend to grow exports for our specialized wires and cables products with specialized uses to meet the anticipated demand from our customers across geographies.

Capitalize on the market opportunity in wires and cables segment, including through innovation and product development to expand our product portfolio

The total domestic market for wires and cables industry is expected to grow at a CAGR of 13% between Fiscal 2023 and Fiscal 2027. (Source: Technopak Report) The emergence of new age sectors such as the construction of Multimodal Logistics Parks (“MMLPs”) as a part of the Gati Shakti National Master Plan, local data centers and airports is expected to drive the increase in demand of wires and cables such as flexible cables, control and instrumentation cables and also FMEG products in India (Source: Technopak Report) In addition, we believe the paradigm shift in the global automobile industry resulting in the setting up of new electrical vehicle infrastructure facilities and electrical vehicle battery manufacturing facilities is expected to increase

the demand for wires and cables, such as EV charging cables. For further details in relation to market size of different sectors such as local data centers, electrical vehicles and real estate and their respective CAGRs, see “*Industry Overview*” on page 139.

We have identified these global trends and have built capabilities to cater to the growing demand for these products. For example, we identified the rollout of 5G capabilities as an area of growth and are currently supplying telecom operators in India with cables for multiple applications for their data center and tower facilities. We have been able to manufacture these products in India and provide our customers in India alternatives to importing these products from manufacturers outside India.

As of June 30, 2023, we have 15 products under development for the wires and cables segment, of which no products have been launched as of the date of this Red Herring Prospectus and the targeted launch date for the remaining products is between September 2023 to September 2024. In particular, we aim to enhance our value proposition to our customers by expanding our wires and cables product portfolio and introducing new product lines through product development and innovation. Additionally, we plan to install a new greenfield project for PVC compound and copper wire and cable manufacturing at the Silvassa Facility, and to expand our electron beam (“**e-beam**”) production facility (for which we have purchased one e-beam machine) and expanded power cable manufacturing at the Waghodia Facility. We also aim to leverage our existing research and development capabilities as well as increase our research and development investments to further capitalize on emerging trends such as EV charging cables and instrumentation and data communication cables.

We believe this will enable us to grow our business by providing customers with a wider range of high-quality products.

Grow and expand FMEG segment organically and inorganically

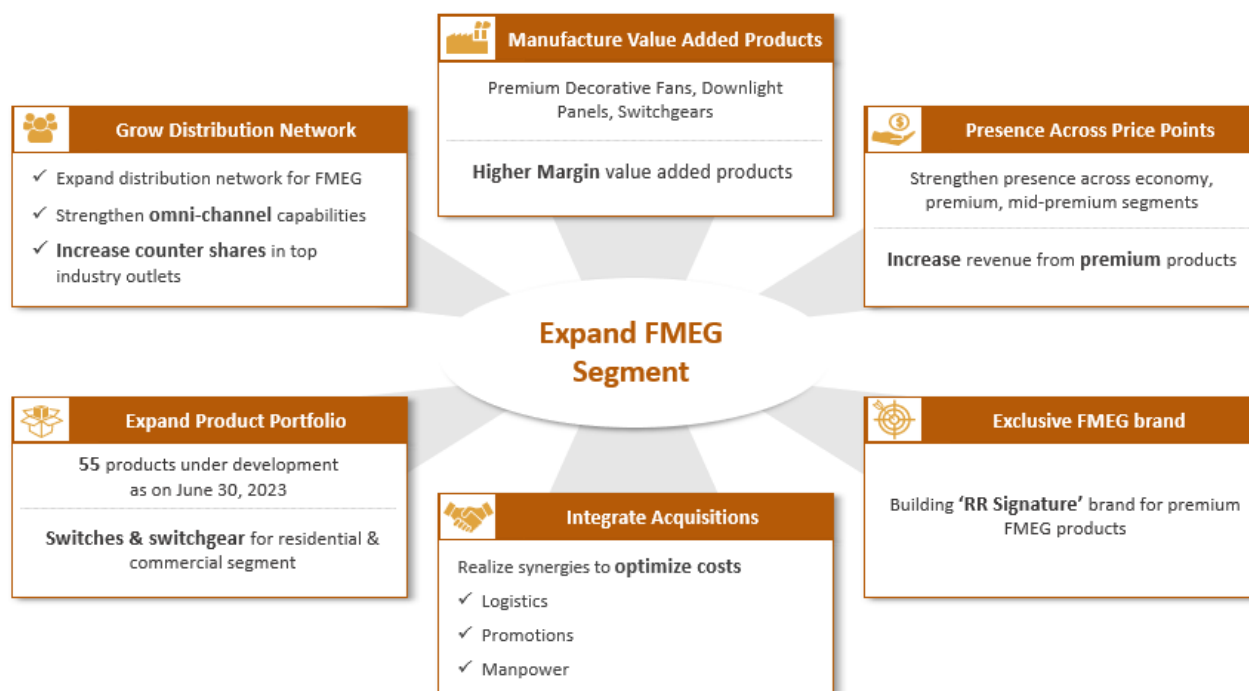

The total domestic market for FMEG industry is expected to grow at a CAGR of 8% between Fiscal 2023 and Fiscal 2027. (Source: Technopak Report) For further details, see “-Strengths – Well-positioned for growth in FMEG segment” and “*Industry Overview*” on pages 199 and 139, respectively.

We also intend to focus on manufacturing value-added FMEG that enjoy higher profit margins such as premium decorative fans and downlight panels ensuring our presence across price points, namely economy, mid-premium and premium segments, and increase the contribution of premium FMEG products to our FMEG portfolio. We have licensed ‘Luminous Fans and Lights’ brand for our premium FMEG products and subsequently, aim to develop and establish ‘RR Signature’ brand for our premium FMEG products in replacement of the ‘Luminous Fans and Lights’ brand by Fiscal 2024. We also intend to leverage the synergies, including in respect of logistics, promotions and manpower, between our business with the HEB of ‘Luminous Fans and Lights’ to optimize our costs. We seek to build our omni-channel capabilities, expanding the distribution network for our FMEG products and to increase counter shares in top industry outlets for our FMEG products. In addition, we aim to

enhance our value proposition to our customers by expanding our FMEG product portfolio and introducing new product lines, including switches and switchgear targeted at residential and commercial segment, through product development and innovation. As of June 30, 2023, we have 55 products under development for FMEG segment. We believe that our strong consumer brand, extensive distribution channel and wide product portfolio position us to capture market share in the FMEG market in India.

We have created dedicated space for switch and switchgear at the Waghodia Facility, and intend to integrate the Roorkee Facility and Gagret Facility over time with capacity addition as well as enhance capacity for the Bengaluru Facility. We also aim to leverage our existing research and development capabilities as well as increase our research and development investments to further capitalize on emerging trends such as smart fans and designer lights. We also evaluate opportunities to grow our business inorganically from time to time.

Enhance productivity and operational efficiencies

We intend to enhance our efforts to improve our productivity and operational efficiencies by investing in technology. We have implemented several low cost automation solutions to improve process reliability, product quality and down times. This includes automating our packing process in the Waghodia Facility with an auto conveyor that has weighing, auto strapping and shrink wrapping capabilities, as well as installing multilayer storage systems.

Further, we have purchased automated machinery such as robotic rotor machining, digitized rotor inspection and automatic paint shop, at our Gagret Facility, that enables us to enhance productivity and quality levels with optimized manpower. We intend to continue automating our manufacturing facilities and Internet of Things (“IoT”) capacity to improve overall equipment efficiencies, by, among other things, collecting data from our production lines with sensors which may be analyzed using algorithms to predict possible outages. We believe this enables us to capture and process data on a real-time basis, which in turn, optimizes the scheduling of our equipment through our enterprise resource planning (“ERP”) systems. We are in the process of introducing certain tools for cost optimization such as robotic process automation in finance in Fiscal 2024 to automate routine manual tasks in accounts payable for vendor invoice processing and accounts receivables. We also intend to deploy advanced analytics based demand forecasting in sales to improve inventory days across the supply chain and our inventory carrying costs. We believe that these initiatives will enable us to improve our profit margins.

Enhancing our environmental initiatives

We adopt a structured approach to developing and implementing our environmental initiatives. This involves the articulation of our environmental goals (including meeting our customer expectations on sustainability), and the identification of material issues along with a gap analysis of our existing policies via peer benchmarking and the selection of green key performance indicators (“Green KPIs”) of our environmental initiatives. Some of these chosen indicators form part of our core sustainability themes, including emissions and climate change, water, diversity, human capital, environment management systems and governance. As of the date of this Red Herring Prospectus, we are monitoring our Scope 1 and Scope 2 greenhouse gas (“GHG”) emissions. Further, we have signed a tripartite agreement for the purchase of electricity from an offsite hybrid solar and wind plant for our Waghodia Facility.

We intend to formalize data capture, measurement, reporting and disclosing of our Green KPIs across our core functions and geographies, to allow us to track our progress towards our environmental goals, and have rolled out our Green KPIs as well as benchmarked against peers for guidance on target setting and internal improvements. We also aim to source hybrid renewable green energy from third party providers with a goal of increasing the contribution of such green energy to our overall energy consumption.

We intend to work on monitoring of targets, implementation of new initiatives, modification of our roadmap (if necessary), strengthening of our social initiatives, rolling out of a sustainable procurement policy and finally work on our carbon disclosure project (“CDP”) and sustainability disclosures (including preparing an annual CDP sustainability report which we aim to be global reporting initiatives referenced). We are also preparing our systems and processes to address the disclosure requirements for Business Responsibility and Sustainability Reporting, introduced by SEBI. For further details, see “- *Description of our Business and Operations - Environmental, health and safety and sustainability initiatives*” on page 225.

Description of our Business and Operations

We are primarily engaged in the manufacturing, marketing and sale of consumer electrical products across two broad segments – wires and cables and FMEG. We are the fastest growing consumer electrical company amongst our peers in India, growing at a CAGR of 43.4% between Fiscal 2021 and Fiscal 2023. (*Source: Technopak Report*) Our revenue from operations also grew by 29.24% between the three months period ended June 30, 2022 and ended June 30, 2023. For further details, see “-*Overview*” on page 190.

Our Products

The table below sets forth a breakdown of our revenue from operations by segments for the periods indicated:

Segment revenue	Fiscal 2021		Fiscal 2022		Fiscal 2023		Three months ended June 30, 2022		Three months ended June 30, 2023	
	(₹ in million)	(% of revenue from operations)	(₹ in million)	(% of revenue from operations)	(₹ in million)	(% of revenue from operations)	(₹ in million)	(% of revenue from operations)	(₹ in million)	(% of revenue from operations)
Wires and Cables	25,202.47	92.52%	41,112.71	93.74%	49,585.32	88.56%	11,058.27	89.47%	14,230.82	89.09%
FMEG	2,036.94	7.48%	2,746.65	6.26%	6,406.68	11.44%	1,300.83	10.53%	1,742.32	10.91%
Total Revenue from Operations	27,239.41	100.00%	43,859.36	100.00%	55,992.00	100.00%	12,359.10	100.00%	15,973.14	100.00%

Our diversified product portfolio spreads across the following focus areas:

Wires and Cables



Our wires and cables portfolio includes a wide range of products such as house wires, industrial wires, power cables and special cables. We manufacture wires and cables in accordance with various Indian and international standards.

We primarily sell our wires and cables under our brand name 'RR Kabel' in India and the international markets. We also manufacture and export certain products under private labels for select customers.

- *House Wires*

House wires are primarily used for residential, commercial and public infrastructures. We manufacture a range of house wires and all the house wires are compliant with REACH, RoHS, CPR and CE. Our key brands are Firex LS0H, Unilay HR FR and Superex FR.



The following table sets forth our key house wire brands along with their characteristics as on June 30, 2023:

Product	Characteristics
Firex LS0H 	Firex LS0H is a safe house wire and it is used in auditoriums, hospitals, hotels, schools, stadiums, and all constructions for public usage where there is a possibility of a fire. It is offered with a class 2 conductor with cross linked halogen free flame retardant insulation.
Unilay HR FR 	Unilay HR FR is a house wire range offered with specially bunched conductors. These wires are heat resistant at 85° C and have flame retardant insulation.
Superex FR 	Superex FR is a baseline house wire and is offered with a class 2 conductor and has flame retardant insulation.

- *Industrial Wires*

We manufacture a range of industrial wires such as single core flexible cables, control cables and submersible flat cables.



The following table sets forth the different types of products in our industrial wires portfolio and their characteristics as on June 30, 2023:

Product	Characteristics
Single core flexible cable 	Our single core flexible cables are designed for internal wirings in power and control panels, switchgears, relay and instrumentation panel. These include cables with PVC, flame retardant, flame retardant low smoke low halogen, heat resistant flame retardant, halogen free flame retardant insulated cables.
Control cable 	Our control cables are primarily used in control panels and cabinets, production and assembly lines, industrial process automation, measurement, control and regulations, plant engineering, conveyor and transport systems, heating and air-conditioning system, industrial machinery and robotic technology. These cables can resist extreme temperature, chemicals, oils and minimizing downtime in case of a breakdown.
Submersible flat cable 	We offer two variants of submersible flat cables – (i) PVC insulated and PVC sheathed flat cables as per IS 694; and (ii) XLPE insulated and PVC sheathed flat cables.

- *Power Cables*

Power cables are primarily used for transmitting and distributing high voltage electrical power and have several industrial and commercial applications. We manufacture a range of power cables such as low tension (“LT”) power cables and medium voltage and high voltage power cables. We manufacture a range of cables with high to low voltage and different sheathings such as PVC, XLPE, flame retardant and low smoke.









The following table sets forth the different types of products in our power cables portfolio along with their characteristics as on June 30, 2023:

Product	Characteristics
LT power cable 	LT power cables are offered with aluminum and copper conductors and with wire and strip armour. These cables are rated for the voltage up to and including 1,100 V.
Medium and high voltage power cables 	Our medium and high voltage power cables are offered in round circular compacted conductor construction. These cables range from 3.3 kV to 33 kV.

- *Special Cables*

We manufacture a range of special cables such as data and communication cables, instrumentation cables, solar cables, fire and security cables, silicon rubber cables, auto cables, EV charging cables, battery cables, lift and elevator cables and appliance wiring material.

The following table sets forth the different types of products in our special cables portfolio along with their application as on June 30, 2023:

Product	Application
<p>Data and communication cables</p> 	<p>Our data and communication cables are suitable for digital signal transmission and are primarily used for road traffic management, air traffic management, health care, water distribution and reservoir, photovoltaic for solar system, integration in oil and gas industries and process automation.</p>
<p>Instrumentation cables</p> 	<p>Our instrumentation cables are used for inter and intra communication and are used in a wide range of application for measuring, supervision and control of process in manufacturing, power transmission and distribution, oil and gas industry, food and beverage and machine building.</p>
<p>Solar cables</p> 	<p>Our solar cables are used for connecting the photovoltaic modules and panels.</p>
<p>Fire and security cables</p> 	<p>Our fire and security cables are particularly suited for use in public buildings and constructions where danger to life, equipment and structures may greatly increase in the event of a power failure especially at the aftermath of a fire. Fire alarm cables may also be used in certain fire alarm systems used in high rise buildings, tunnels and industrial infrastructure.</p>
<p>Silicon rubber cables</p> 	<p>Our silicon rubber cables are primarily used in steel industries, cement industries, glass industries, ship buildings and aviation.</p>
<p>Auto cables</p> 	<p>Our auto cables are used in automotive lightings, signals and instrument panel circuits in automobiles.</p>
<p>Lift and elevator cable</p> 	<p>Our lift and elevator cables are used in domestic and commercial lifts, overhead cranes, horizontal cranes, material handling systems, floor conveyer systems and shelf control units.</p>
<p>Appliance wiring material</p> 	<p>Our appliance wiring material contains a range of single, multicore and special cables for internal wiring of panels and electrical equipment as per UL/CSA standards.</p>
<p>Battery cables</p> 	<p>Our battery cables are highly flexible single core cable available with PVC or elastomeric insulation. These are resistant to acid, chemical, oil and solvents.</p>

Product	Application
Power cord 	Our power cords are 2-pin and 3-pin molded cords for various domestic and industrial appliances and gadgets. The range is also offered with customized molding and cable selection.

FMEG

Our FMEG portfolio includes a wide range of products such as fans, lighting, switches, switchgears and appliances. Our FMEG products are primarily used by residential consumers and commercial users, including retail malls, office spaces, hospitals and public infrastructure. In addition, we produce customized products for our customers, based on their requirements, specifications and performance expectations.

In Fiscal 2020, we acquired LED Lights Business of Arraystorm, along with its trademarks and design certificates (other than ‘Ethos’, ‘Adappt’ and ‘WIoT’ trademarks), which added professional lighting fixtures and LED lights to our portfolio. Further, pursuant to our recent acquisition of HEB of ‘Luminous Fans and Lights’ in May 2022, we added lights and premium and mid-premium fans thereby expanding the product portfolio in our FMEG segment. Pursuant to a brand license agreement dated May 1, 2022 entered into with Luminous Power Technologies Private Limited (“LPTPL”), we have been granted a limited, exclusive, non-transferable, non-assignable and non-delegable license to use the ‘Luminous Fans and Lights’ brand for an initial period of two years subject to extension of six months at a time for a maximum of four times with effect from May 1, 2022, out of which we paid a lumpsum amount of ₹50.00 million as royalty for use in the first two years. Further, we need to pay royalty of ₹50.00 million on a semi-annual basis for the remaining two years to use the brand. We have a one-time option to extend the license for a period of three months and have to pay ₹25.00 million as royalty for such extension. We have licensed ‘Luminous Fans and Lights’ brand for our premium FMEG products and subsequently, aim to develop and establish ‘RR Signature’ brand for our premium FMEG products in replacement of the ‘Luminous Fans and Lights’ brand over time through Fiscal 2024.

We primarily sell our FMEG products under the ‘RR’ and the ‘Luminous Fans and Lights’ brands licensed by us, in India.

- *Fans*

We manufacture a range of fans such as ceiling fans, table pedestal wall fans and exhaust fans. The main structural components of fans are blades, motors, shaft, canopy and capacitor. As on June 30, 2023, we sell economy, mid-premium and premium fans. Economy fans are basic fans with no trims, simple blade designs and induction motors at a price range of below ₹1,500. Mid-premium fans are fans with inclusion of some or all of decorative trims, higher speed, higher air delivery, multiple color options at a price ranging from ₹1,500 to ₹3,000. Our premium fans have additional features such as under lamp, BLDC motor, metallic or textured paints and decorative trims and are priced above ₹3,000, and include our Luminous Jaipur Tamra and Luminous Brooklyn models.



The following table sets forth the different types of products in our fans portfolio and the respective number of models as on June 30, 2023:

Product	Models
Ceiling fans	79
Table pedestal wall fans	44
Exhaust fans	23

- *Lighting*

We manufacture a range of lightings such as bulbs, batten, down lighter, panels, downlights, ring lights, LED lights, and professional lighting such as street lights, linear and suspended linear, highbay lighting and flood lights. We sell our range of professional lights largely through our B2B channel and our range of LED lights directly to end-consumers. The main structural components of lightings are led and driver.



The following table sets forth the different types of products in our lighting portfolio and the respective number of models as on June 30, 2023:

Product	Models
Retail: Bulb, Batten, Down lighter, Panels, Street Light	67
Project: Panel, Downlights, Linear, Suspended Linear, Highbay Lighting, Flood Light	144

- *Switches and Switchgear*

We manufacture a range of switches such as doorbells, spike guard, flexible cord, switches, sockets, fan regulator and other accessories and. We also produce and outsource the production of switchgear such as miniature circuit breaker (“MCB”), distribution board, residual current circuit breaker, mould case circuit breaker and change over switch.



The following table sets forth the different types of products in our switches and switchgear portfolio, and the different types of products outsourced in our switchgear portfolio, and the respective number of models as on June 30, 2023:

Product	Models
Modular switches (Maven)	72
Modular switches (Connect)	98
MCB	95
Distribution Boards	70
General accessories (Holder)	8
General accessories (AC Box)	1
General accessories (Spike Guard)	1
Boxes (Plastic)	24
Boxes (Metal)	11

- **Appliances**

We purchase a range of appliances such as water heaters, irons, room heaters and coolers from third parties and sell them as traded goods. The main structural components of appliances are tanks, heating elements and cooler motor.



The following table sets forth the different types of products in our appliances portfolio and the respective number of models as on June 30, 2023:

Product	Models
Water Heaters	8
Irons	13
Room Heaters	4
Coolers	10

Manufacturing Facilities

We own and operate five integrated manufacturing facilities across India. We procure most of our machinery from countries such as Germany and Taiwan.

Waghodia, Gujarat (“Waghodia Facility”)

We commenced operations at our Waghodia Facility in Fiscal 2012. We manufacture wires and cables, PVC compound and switches at our Waghodia Facility. Furthermore, the Waghodia Facility manufactures majority of our products for the export market. The Waghodia Facility sources power from Madhya Gujarat Vij Company Limited and utilizes in-house solar energy through the roof top solar panels with 1.2 MW generating capacity. In addition, we have installed a 66 kV express substation which ensures uninterrupted power supply with a maximum demand of 8.5 MW. We source our water from our two tube wells and we also recharge ground water using rain from roof top and surface.

Silvassa, Dadra and Nagar Haveli and Daman and Diu (“Silvassa Facility”)

We commenced operations at our Silvassa Facility in Fiscal 1999. We manufacture wires and cables and PVC compounds at the Silvassa Facility. Furthermore, the Silvassa Facility manufactures majority of our products for our domestic market. The

Silvassa Facility sources power from the DNH DD Power Distribution Corporation Limited and water from the five tube wells installed at our Silvassa Facility. We have also installed roof top solar panels generating capacity of 0.25 MW.

Roorkee, Uttarakhand (“Roorkee Facility”)

We acquired the Roorkee Facility in Fiscal 2019. It was established in in Fiscal 2013. We manufacture fans and lights at the Roorkee Facility. The Roorkee Facility sources power from Uttarakhand Power Corporation Ltd.

Bengaluru, Karnataka (“Bengaluru Facility”)

We acquired the Bengaluru Facility in Fiscal 2020. It was established in Fiscal 2016. We manufacture lights at the Bengaluru Facility. The Bengaluru Facility sources power from the Bengaluru Electricity Supply Company.

Gagret, Himachal Pradesh (“Gagret Facility”)

We acquired the Gagret Facility in Fiscal 2023. It was established in Fiscal 2010. We manufacture fans at the Gagret Facility. The Gagret Facility sources power from Himachal Pradesh State Electricity Board Limited and water from the tube well installed at our Gagret Facility.

Capacity and Capacity Utilization

The following table sets forth the installed production capacity of our manufacturing facilities and the capacity utilization for the Fiscals 2021, 2022 and 2023 and three months ended June 30, 2022 and June 30, 2023:

Facility	Products	Unit of measurement	Fiscal 2021		Fiscal 2022		Fiscal 2023		Three months ended June 30, 2022		Three months ended June 30, 2023	
			Installed production capacity	Capacity utilization (%)	Installed production capacity	Capacity utilization (%)	Installed production capacity	Capacity utilization (%)	Installed production capacity	Capacity utilization (%)	Installed production capacity	Capacity utilization (%)
Waghodia Facility	Wires and cables – copper and aluminum	CKM	1,349,850	55%	1,719,300	62%	2,116,620	62%	490,710	61%	563,230	69%
	Various types of compounds [#]	Mts	25,300	64%	39,950	55%	40,400	63%	10,050	59%	10,200	73%
	Switch	Numbers	900,000	17%	5,683,000	59%	8,925,000	81%	2,372,700	98%	2,498,400	83%
Silvassa Facility	Wires and cables	CKM	1,941,000	61%	1,941,000	67%	1,936,000	87%	485,042	63%	484,000	72%
	Various types of compounds [#]	Mts	13,200	65%	13,200	75%	13,200	86%	3,300	86%	3,300	86%
Roorkee Facility	Fan	Numbers	1,500,000	29%	1,500,000	35%	1,500,000	50%	375,000	54%	375,000	63%
	Light	Numbers	5,512,500	62%	3,900,000	42%	1,800,000	32%	450,000	35%	450,000	18%
Gagret Facility	Fan	Numbers	-*	-*	-*	-*	1,650,000	42%	412,500	42%	412,500	54%

Facility	Products	Unit of measurement	Fiscal 2021		Fiscal 2022		Fiscal 2023		Three months ended June 30, 2022		Three months ended June 30, 2023	
			Installed production capacity	Capacity utilization (%)	Installed production capacity	Capacity utilization (%)	Installed production capacity	Capacity utilization (%)	Installed production capacity	Capacity utilization (%)	Installed production capacity	Capacity utilization (%)
Bengaluru	Light	Numbers	132,096	50%	121,088	81%	132,096	81%	30,272	76%	33,024	79%

Various types of compounds includes PVC compound, LS0H compound, XLPE compound and solar cable compound.

* We acquired Gagret Facility during Fiscal 2023. Capacity of Gagret factory considered from May 1, 2022.

Manufacturing Process

We manufacture our products at our five integrated manufacturing facilities. These processes use a combination of mechanized and human skill to achieve the desired standards.

Wires and Cables

The following sets forth the typical manufacturing process of our wire and cables products:

- **Wire Drawing:** Aluminum or copper rods are first fed to drawing machines and pulled through a series of dies. During this process, the metal cross-section is reduced by the process of wire drawing and elongation, and drawn wire of the desired size is obtained.
- **Multi wire drawing:** In copper cable manufacturing, multi wire drawing is another added process where multiple wires are drawn simultaneously which produces a group of finely drawn copper wires.
- **Tinning:** Tin coating on copper conductor through electrolytic process.
- **Annealing:** During the drawing process, the wires are also simultaneously heated and subsequently crystallized by cool water so as to soften the wires and increase their flexibility and electrical properties, depending on the various specification of the products.
- **Bunching/Stranding:** Several aluminum wires or copper wires are twisted together in pre-defined lay length to form the conductor.
- **Insulation:** The wires are then coated with materials, such as PVC, polyethylene, XLPE, LS0H etc. to provide insulation through an extrusion process.
- **Triple Extrusion:** This is an insulation process largely for medium, high and extra voltage cables. The conductor screen, insulation and insulation screen layers are applied simultaneously during the catenary continuous vulcanizing (CCV) with dry cure and dry cool extrusion process.
- **Spark Testing:** Spark testing is carried on an outline of insulated cores to check for defects in insulation.
- **Screening:** Various special cables like instrumentation cables, data cables, fire cables are subjected to the process of screening with aluminum mylar tape, tinned copper wire braiding, heat barrier tape etc. to comply with the requirements of the applicable standards.
- **Copper Tapping:** Copper taping is used in medium, high and extra high voltage cores as a screening for equal distribution of electrical stress on the cable surface as well as draining of the leakage current.
- **Laying Up:** The insulated cores in the cable are laid-up in various machine like single twist buncher, double twist buncher, stranding machine and drum twister depending on the product type.
- **Inner Sheathing:** A layer of plastic or rubber composite is extruded/wrapped onto the laid-up core assembly to hold the insulated cores together.

- *Armoring*: Armoring requires a machine to wrap metallic or non-metallic wires or tapes over the inner-sheathed cable assemblies, which allows cables to withstand mechanical and electrical stress.
- *Metallic Corrugated Sheath*: Aluminum corrugated sheath profile in combination with the water swellable tapes to protect against mechanical damages.
- *Outer Sheathing*: An additional layer of plastic or rubber composite is added as an outer sheath with additional properties as per the relevant applicable standard.
- *Testing*: Routine, acceptance and type testing is carried out as per the applicable standard.
- *Packing*: Various packing types like coil packing, reel packing, box packing, drum packing are followed depending on the requirement and suitability of the product.

FMEG

Fans

The following sets forth the typical manufacturing process of our fans products:

- *Blade Fabrication Process*: Aluminium and steel sheets are cut to size, punched and bent to give them the shape of a fan blade, before the blade leaf is assembled with the shank to prepare for mounting with the motor.
- *Stator Making Process*: The stack is wound with copper and aluminium wires, tested for quality parameters and varnished for protection. The shaft is pressed into the wound and varnished stator, which is followed by grinding of the stator outer diameter.
- *Cover Computerized Numerical Control ("CNC") Process*: Aluminium and steel covers are machined as per drawing parameters on computerized machines and are checked using digital gauges.
- *Rotor CNC Process*: Casted rotors are machined as per drawing parameters on computerized machines and are checked using digital gauges. The machined rotors are coated with lacquer to give its surface a protective film.
- *Surface Treatment Process*: Fabricated blades and machined covers are passed on through seven tank processes to remove dust, oil and foreign particles, and to coat their surface with a protective coating.
- *Paint and Powder Coating Process*: Pre-treated blades and covers are painted with epoxy powder and liquid paint to give their surface a protective coating with an appealing look.
- *Blade Assembly Process*: Painted blades are assembled with decorative plastics, and their specifications are checked followed by packing them in a set (as per the model's requirements).
- *Final Assembly*: As per the model's requirements, decorative plastic, painted covers, ground stator and machined rotors are assembled together using hardware. After the assembly of the capacitor, the fans are tested in a silent testing room for any electrical, audio and visual defects. Motors which pass the test are marked with stickers.
- *Packing Process*: As per the model's requirements, the motors are packed along the specified accessories (canopy, shackle, down rod etc.) in motor boxes and the packed motor box is packed into master boxes along with a blade box and is subsequently ready for dispatch.

Lighting

The following sets forth the typical manufacturing process of our professional lighting product:

- *Process of Housings*: The pre-powder coated aluminum extrusions are cut using an automated double edge saw which cuts both ends of the extrusions precisely as well as at complicated angles. The various drilling and tapping operations are then done using precise jigs and fixtures depending on the size and type of products.
- *Process of Mountings of LEDs onto the Printed Circuit Boards (PCBs)*: The PCBs are first applied with lead free solder paste using an automated stenciling machine. These subsequently undergo an automated feeder rollers into "Pick and Place" Surface Mounted Technology (SMT) machine which automatically picks the LED from spools and using a computer numerical controlled program, depending on various products, places it onto the PCB automatically. This PCB mounted

LED is automatically pushed through roller feeders into a 8-stage temperature controlled oven, where the eight temperature zones can be programmed depending on the size of PCB and type of LED. At the end of the line, the electrical test is done before it is sent to the final assembly.

- *Final Assembly of Luminaires:* In these lines, all the sub-assembled parts of luminaire like housings, PCB mounted LEDs, drivers and acrylics are assembled together and every assembled product is subjected to an electrical test by an automated electrical testing machine.
- *Final Testing of Luminaires and Burn-in Test:* These assembled products are then subjected to a three hour of burn-in test where the products are switched on at elevated temperatures to ensure all soldering process of electronics are stable. The product are then re-tested for final electrical parameters.
- *Packing and Project Management of Products:* The tested products are then packed into boxes and labelled as per its projects, floors, formations and color coding, and sent to the finished goods area.

Switches

The following sets forth the typical manufacturing process of our switch products:

- *Moulding:* We mould each plastic component for switch and all accessories.
- *Assembly:* The brass parts are supplied to the manual assembly lines in the plant, along with the in-house plastic components. The plastic parts and the brass parts are assembled, in a linear process, subsequent to which various on-line testing is done including high voltage test and continuity check. In addition, a statistical quality check is done to check the number of operations they can withstand.
- *Specialization:* For certain specialized processes, such as textured plates or plates with wood finish, we use external vendor for the job work.
- *Packing:* Each switch and accessories is then packed into a box, which is then further packed into a wholesale pack and further into a carton for distribution.

Contract Manufacturing

As of June 30, 2023, third party contract manufacturing contributed to 8.03% of our revenue from operations. We depend on these contract manufacturers to allocate to us a portion of their manufacturing capacity sufficient to meet our needs, to produce products of acceptable quality and at acceptable manufacturing yields and to deliver those products to us on a timely basis and at acceptable prices. We enter into master supply agreements with these third party contract manufacturers for our FMEG products, pursuant to which they agree to provide, among others, components (used in manufacturing of our products) and finished goods. Most of these master supply agreements are fixed-term contracts or have short duration of approximately three years and are not subject to automatic renewal. Some of our agreements are terminable by the contract manufacturer at a short notice.

Sales and Marketing

We have a diverse customer base comprising distributors, dealers, retailers, electricians, institutions, governmental authorities and OEMs. Our customers are from a range of industries including real estate (including commercial and residential construction), infrastructure, automobile, telecommunication, railways, textile, pharmaceutical, paint, cement and data centers.

Distribution

Our global distribution footprint encompasses both domestic sales within India and export sales across the world:

- *Domestic:* We have an extensive pan-India distribution presence and as on June 30, 2023, we have 3,450 distributors, 3,656 dealers and 114,851 retailers. As part of our distribution strategy, we strive to provide our end-users a seamless experience through several touchpoints. The distributors purchase products from us and on-sell our products to end-users through retailers. Dealers purchase products from us and either, directly or through retailers, on-sell to end-users. The dealers, distributors and retailers, directly and indirectly, cover electricians. Such a distribution model also enables us to get information from the distributors and dealers on a real-time basis of stock availability, sales data of retailers, performance of our product segments and SKUs as well as the effect of our policies and schemes.

As on June 30, 2023, we have 789 employees in our sales and marketing force, who manage and coordinate with distributors, dealers and retailers. Our sales force regularly covers electrical retail outlets linked to distributors and ensures that stock is replenished, the finances are settled efficiently and that material is returned effectively. We have also established an “IB team” in certain Metros and Tier I cities, to help identify new constructions of individual bungalows and contact the end-user. According to Technopak, Metro cities are Delhi National Capital Region and Mumbai, and Tier I cities are cities with a population between 1 million and 5 million. This enables us to be involved at all stages of the construction, i.e. from the construction phase when wires are installed until the final stage when switches and fans are purchased.

We also have a presence on recognized e-commerce platforms.

In ‘winner’ states, we are identifying micro and nano markets, at the pin code (for districts, cities and villages) and taluka levels (for sub divisions of districts), within these regions to focus our distribution coverage, sales force coverage and marketing efforts. For instance, in the state of Gujarat, we have piloted the mapping of 415 micro-markets with their respective sales force and distribution coverage routes, as of June 30, 2023. To strengthen our distribution network, we have undertaken several initiatives. We launched an initiative ‘Project KaRRma’ in Fiscal 2020, to achieve a higher market share in housing wires by expanding retail outlets, electricians, sales force and product portfolio. We also launched another five-year long initiative ‘Project Lakshya’ in Fiscal 2020 with an object to organically and inorganically grow our FMEG segment. From Fiscal 2021 to Fiscal 2022, and from Fiscal 2022 to Fiscal 2023, our revenue from operations from FMEG segment grew by 34.84% and 133.25%, respectively. In addition, as a result of these initiatives, the number of electricians, distributors, dealers and retailers has increased from Fiscal 2021 to three months ended June 30, 2023 and the following table sets forth the number of distributors, dealers, retailers and electricians for the periods indicated:

	Fiscal 2021	Fiscal 2022	Fiscal 2023	Three months ended June 30, 2022	Three months ended June 30, 2023
Electricians	61,224	147,810	271,264	179,901	298,084
Distributors	1,423	1,844	3,296	2,631	3,450
Dealers	2,810	3,092	3,444	3,173	3,656
Retailers	30,570	58,872	106,626	67,811	114,851

Between Fiscal 2021 and the three months ended June 30, 2023, the number of electricians, distributors, dealers and retailers grew by 4.87 times, 2.42 times, 1.30 times and 3.76 times, respectively. Further, the following table sets forth the number of distributors and dealers across the central, eastern, northern, southern and western regions of India for the periods indicated:

	Fiscal 2021	Fiscal 2022	Fiscal 2023	Three months ended June 30, 2022	Three months ended June 30, 2023
Central	1,051	1,182	1,608	1,459	1,724
East	437	560	837	713	895
North	1,066	1,196	1,603	1,409	1,701
South	892	1,093	1,576	1,204	1,622
West	787	905	1,116	1,019	1,164
Total	4,233	4,936	6,740	5,804	7,106

Further, according to Technopak, electricians are key decision makers in the consumer electrical industry, and in respect of housing wires, form the major segment of customers in the value chain. We have implemented a partner loyalty program for retailers and electricians, including RR Connect’s mobile phone application and web portal, and rewards schemes, such as RR Dosti 3.0 and Udaan 3.0. Our Kabel Star initiative further provides scholarships to the children of electricians who have registered on our RR Connect application. For further details, see “-Description of our Business and Operations – Sales and Marketing” on page 213.

As on June 30, 2023, we have 21 warehouses across 17 states and union territories in India. We intend to consolidate our warehouses over time. Our warehouses are strategically located to optimize our distribution by transport with the objective to achieve optimal balance between lead time to service and total distribution cost.

In addition, we have a focused approach towards expanding our geographical market share in India. For instance, for our 90 meters housing wires, we have classified our geographical presence in India into ‘winner’, ‘growing’ and ‘opportunity’ states. We classify ‘winner’ states as states where we have more than 9% market share by value, in Fiscal 2023 and three months ended June 30, 2023; ‘growing’ states as states where we have 5% to 8.9% market share by value, in Fiscal 2023 and three months ended June 30, 2023; and ‘opportunity’ states as states where we have less

than 5% market share by value, in Fiscal 2023 and three months ended June 30, 2023. Over time, we intend to classify our geographical presence in the same manner for all of our products.

The following map and table indicate our growth in these states from Fiscal 2021 to three months ended June 30, 2023:

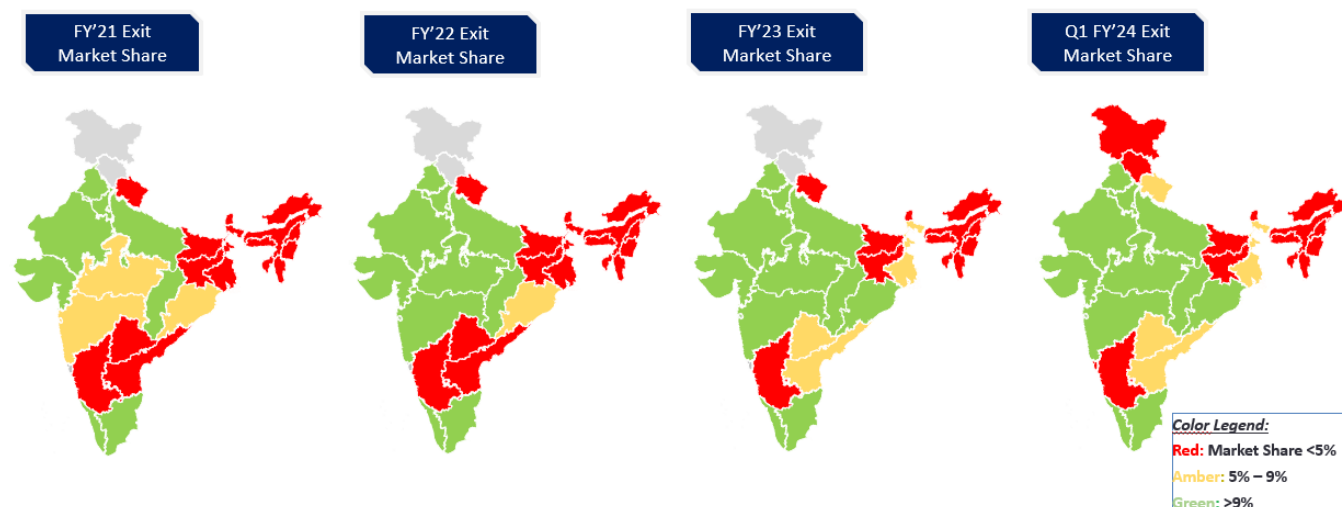

	Fiscal 2021	Fiscal 2022	Fiscal 2023	Three months ended June 30, 2023
'Winner' states	9	11	12	12
'Growing' states	3	1	3	4
'Opportunity' states	15	15	12	15

- Export:** We extend our business strategy to export markets and focus on recurring B2C exports. In calendar year 2022, we were one of the leading exporter of wires and cables from India, in terms of value, representing approximately 9% market share of the exports market from India. (Source: Technopak Report) We export our range of wires and cable products directly as well as through distributors across the world. We started exporting our products to UAE in Fiscal 2001 and later expanded to other countries in North America, APAC, Europe and Middle East. Our revenue from operations from outside India increased from ₹5,867.66 million in Fiscal 2021 to ₹12,701.90 million in Fiscal 2023 and from ₹3,436.30 million in three months ended June 30, 2022 to ₹4,303.73 million in three months ended June 30, 2023. During Fiscals 2021 to 2023 and three months ended June 30, 2023, we sold our products to 63 countries in North America, APAC, Europe and Middle East. For the three months period ended June 30, 2023, 99% of our export revenue was derived from distributors, and 1% was derived from OEMs.

We sell the majority of our wires and cables products under our brand 'RR Kabel' and manufacture under private labels for select customers and have long-standing relationships with 10 distributors in these markets who cover the majority of our exports. Revenue from outside India contributes 26.94% of our revenue from operations for the three months period ended June 30, 2023. Leading players like us are well-positioned to benefit from the global shift from China-based manufacturing to China plus one strategy resulting in a share gain for Indian manufacturers in the global market. (Source: Technopak Report)

For further details in relation to our revenue split by geographical area, see "Management's Discussion and Analysis of Financial Condition and Results of Operations-Segment Reporting" on page 388.

Additionally, we depend on our network of shipping agents for, among other things, cargo handling, transportation and delivery at the destination and load port for export cargo and import cargo.

Contractual Arrangements

We sell our products through memoranda of understanding ("MoUs") with distributors and certain customers within India and across the rest of the world, on a non-exclusive basis. Most of the MoUs with our customers in the business-to-business channel have a term of approximately one year. These MoUs may be renewed or extended in accordance with the terms of such MoUs. These MOUs usually specify minimum quantities of a particular product or categories of products that a customer or distributor is required to purchase when they purchase our products. Our contractual arrangements with our dealers and our remaining

customers are predominantly purchase orders. We sell our products under our own brand. Further, we issue purchase orders to our international shipping agents at each time their services are required.

Pricing

Our products are offered at various price points. Our sales and marketing team takes into consideration factors such as consistency, landing costs (dealer and net) and discounts (such as turnover discounts upon achievement of target), and applicable taxes to arrive at the list price of our offerings. Our products are priced competitively amongst our competitors. To counter the volatility in the price of raw materials, we follow a policy of adjusting the percentage of discount for a product on a monthly basis. When the fluctuation in the price of raw materials goes beyond a certain level during the period concerned, list prices of products are revised as and when required.

Manufacturing Defects and Product Warranties

We typically provide a warranty of one to two years against manufacturing defects for our FMEG products. Any defect in our finished FMEG products may result in customers making a guarantee / warranty claim, and we typically offer to repair / replace our customer products in response to the guarantee / warranty claim. We have had warranty claims made against our products in the ordinary course of our business. For further details, see “*Risk Factors – We are subject to strict quality requirements and any product defect issues or failure by us or our raw material suppliers to comply with quality standards may lead to the cancellation of existing and future orders, recalls or exposure to potential product liability claims*” on page 42. We typically do not provide a guarantee or warranty against manufacturing defects on our wires and cables products, which are in line with the standard practice in the industry in which we operate.

The following table sets forth the number of customer complaints we received for the respective periods:

Particulars	Fiscal 2021	Fiscal 2022	Fiscal 2023	Three months ended June 30, 2022	Three months ended June 30, 2023
Wires and cables	175	260	201	79	67
FMEG	85,539	88,562	131,737	29,536	47,313
Total	85,714	88,822	131,938	29,615	47,380

Our Company has redressed 100% of the complaints we have received. For our wires and cables products, we redress the complaints by first ascertaining if it is a product or application related complaint, and we thereafter analyze and respond to the relevant party with solutions. For our FMEG products, we either repair or replace the items through our service centers.

Sales and Marketing

Our marketing and sales efforts are a combination of digital and physical initiatives spread across multiple touch points where consumers discover our brand and product offerings. We have implemented digitized technology-enabled services to manage our partners. We have a mobile application for RR Connect and the cumulative application downloads and registrations has increased from 61,224 in Fiscal 2021 to 271,264 Fiscal 2023 and 298,084 in three months ended June 30, 2023. This mobile application has helped us to track user-wise tertiary sales and primarily incentivize them through initiatives such as loyalty tier upgrades and long-term reward bonus points.

Over Fiscals 2021, 2022 and 2023 and three months ended June 30, 2022 and June 30, 2023, we have spent ₹259.61 million, ₹491.29 million, ₹851.43 million, ₹134.45 million and ₹188.15 million, respectively, towards advertisement and business promotion expenses, constituting 0.95%, 1.12 %, 1.52%, 1.09% and 1.18% of our revenue from operations over the same period. This constitutes an overall advertisement and business promotion expenses of ₹1,790.48 million since Fiscal 2021 up to the three months ended June 30, 2023. We curate our advertising campaigns to spread awareness about choosing quality wires.

As of June 30, 2023, our sales and marketing force had 789 employees. Our sales and marketing personnel are strategically located in 176 cities across India to ensure direct and efficient communication with our customers and timely services. In particular, we have a chief sales officer and retail zonal managers in charge of each zone, East, Central, South and North. The sales support teams and state heads report into these retail zonal managers. Further, we also have a separate National Sales Head (Key Accounts Manager) and a pricing desk that reports into the chief sales officer. Our team is responsible for sales of

products to the customers, increasing the level of new business, costing, negotiation and commercial settlements, monitoring and ensuring profitable business growth while improving the customer relationship. The sales team also takes an active role in winning new business, maintaining current business with customers, promoting new technology products and marketing the same for project acquisitions.

Our recent marketing initiatives have been based on the core philosophy of tapping retailers and key influencers in the chain, which are electricians. We started connecting with this target audience with the aim of winning them as customers and ambassadors for our products and brand. We launched several initiatives to increase awareness of our brand and product such as Kabel Shop, Kabel Nukkad, Kabel Mela, Kabel Link, and Kabel Star. We built our customer base and awareness around the brand in core target groups using the following initiatives:

Kabel Nukkad – This was an initiative started by us to engage with electricians associated with the retailers at a particular retail shop. We invite the electrician at the closest retail shop they are in touch with, where we educate them about our products through product demonstration and onboard them in our Loyalty Management Program using our RR Connect application.

Kabel Shop – We organize a meet up in a particular town/ suburb with the key electricians of that locality. We engage them through our product display, product presentation and talk about Loyalty Program benefits in detail.

Kabel Mela – We undertake these initiatives in a large city/ metro where we invite electricians through their trade associations. We carry these out in a large forum where apart from our product displays, product presentations, we also establish a social connect through free medical camps and cultural activities for participants.

Kabel Link – This is focused towards the architects and electrical consultants, where we educate them on our product portfolio and the technical specifications of our products.

Kabel Star – Under this initiative, we provide scholarships to the children of electricians. As a prerequisite, the electrician should be registered on our RR Connect application. In the very first year of its roll out, in Fiscal 2023 we have awarded scholarships in excess of ₹10 million to a total of 1,015 students across India.

CCC (Chai Charcha Chaupal) – This initiative is focused on our target rural markets where our sales team used to travel through vans extensively covering rural markets at a stretch of a particular area/state onboarding retailers and electricians during the course of the journey.

Loyalty Management Program / RR Connect App – In our wires and cable segment, electricians play a vital role as a key influencer in the entire buying journey. Hence, engaging and building loyalty with the electricians is crucial. Through different marketing activities mentioned above we onboard electricians and manage our relationships with them through our RR Connect App. We have also implemented programs to incentivize electricians to continue engaging with us, and these include rewards schemes, such as RR Dosti 3.0 and Udaan 3.0, which allow electricians to earn points and rewards from the sale and scan of our wire products.

We track the total registered and new users on our application periodically and have seen the total users increase as follows:

	Fiscal 2021	Fiscal 2022	Fiscal 2023	Three months ended June 30, 2023
New Users	35,171	86,586	123,454	26,820
Cumulative registered users	61,224	147,810	271,264	298,084

Based on the data generated through the usage of our application by electricians, we are able to monitor location, secondary sales (from distributor to retailer) and tertiary sales (from retailer to electrician), on a real time basis.

#WirekaFireTest – This was an initiative to demonstrate the quality of our wires by putting it to test under an external fire. As a part of the initiative we ran a viral campaign in which we invited videos from electricians and retail partners of their recorded personal demonstration of FIREX (Low Smoke zero Halogen). We received 1000+ entries from across India. The campaign and the overall initiative has helped us create awareness about the fact that smoke is more lethal than fire and our high quality FIREX range does not propagate fire or emit toxic black smoke. We were able to demonstrate the advantages of our product compared to other products using this campaign.

Above the line initiatives – As a strategy to enhance our brand awareness we have undertaken several outdoor campaigns by placing our bill boards at police stations, religious places, fire stations, residential society. We also engaged a leading Indian Bollywood actor to associate with us as our brand ambassador.

We have also undertaken specific advertising campaigns to highlight our brand and products. We also undertake sponsorship of sports teams and events to highlight our brand to different audiences. For example, we were one of the brand sponsors for the Bengaluru Pro Kabaddi league and the Indian Premier League - Kolkata Knight Riders sports team. We have been the title sponsor of all the editions of a real estate industry award for the last 14 years, to help us create awareness amongst the real estate developer community.

Digital and social media –we have been doing multiple engagement campaigns across social media and digital platforms. These digital channels are also being used to promote our range of products across wires and cables and FMEG.

Procurement and raw materials

Our primary raw materials include aluminum, copper, galvanized iron, packing material, LSOH, master batch, solar compound, PVC compound and XLPE compound. We manufacture PVC compound, LSOH compound, XLPE compound and solar cable compound at our Waghodia and Silvassa Facilities. The following table sets forth details of our cost of materials for the respective periods shown:

	Fiscal 2021	Fiscal 2022	Fiscal 2023	Three months ended June 30, 2022	Three months ended June 30, 2023
Revenue from operations (₹ million)	27,239.41	43,859.36	55,992.00	12,359.10	15,973.14
Cost of materials consumed (₹ million)	21,731.99	35,755.15	43,697.88	10,401.30	11,971.13
% of revenue from operations (%)	79.78	81.52	78.04	84.16	74.95

The following table sets forth the amount of domestically and non-domestically sourced materials for the respective periods shown:

	Fiscal 2021	Fiscal 2022	Fiscal 2023	Three months ended June 30, 2022	Three months ended June 30, 2023
Domestically sourced materials (₹ million)	15,727.72	25,658.36	30,369.40	7,043.66	9,254.40
Domestically sourced materials as a % of total purchase of materials* (%)	72.23	70.78	70.25	65.27	76.46
Non-domestically sourced materials (₹ million)	6,047.46	10,592.98	12,861.00	3,747.51	2,849.65
Non-domestically sourced materials as a % of total purchase of materials* (%)	27.77	29.22	29.75	34.73	23.54
Total purchase of materials*	21,775.18	36,251.34	43,230.40	10,791.17	12,104.05

*Total purchases of materials is calculated as a sum of purchases of inventories from business acquisition and purchases. For further details, see "Restated Consolidated Financial Information – Annexure VI – Notes to Restated Consolidated Financial Information Note 23A: Cost of Materials Consumed" on page 324.

While we manufacture up to 99.71%, 24.33%, 50.59% and 0.37% of our requirements for PVC compound, LSOH compound, XLPE compound and solar cable compound, respectively, at our facilities for the three months ended June 30, 2023, we

purchase our remaining requirements from third parties on a spot basis. We source our raw materials from suppliers in India and other countries such as UAE, Thailand, Japan and Taiwan. We have agreements with several suppliers, primarily for copper and aluminum, pursuant to which we have a 30 to 45 days window to price our products from the date of delivery of raw material.

For other suppliers with whom we do not have such pricing windows, as a general policy, we aim to purchase these commodities at prevailing market prices and sell the products at prices adjusted for the prevailing market prices. The prices of copper and aluminum are linked to the prices on the London Metal Exchange (“LME”). Accordingly, the price we pay for these raw materials can fluctuate due to volatility in the commodity markets and in exchange rates. We have a risk management policy covering our foreign exchange risk, which is reviewed periodically by our management. We usually enter into foreign exchange forward contracts to mitigate our foreign exchange risk. For further details on the cost fluctuations we experience in respect of our primary raw materials, see “*Management’s Discussion and Analysis of Financial Condition and Results of Operations-Segment Reporting*” and “*Risk Factors – The costs of the raw materials that we use in our manufacturing process are subject to volatility. Increases or fluctuations in raw material prices may have a material adverse effect on our business, financial condition, results of operations and cash flows.*” on pages 388 and 28.

We usually keep 20-25 days of inventory of raw materials and work-in-progress goods at our facilities. The ability to store raw materials and work in progress goods at our facilities enables us to withstand disruptions in supply as well as volatility in the price of raw material. We plan our inventory levels based on historical levels of sales, actual sale orders on hand and the anticipated production requirements taking into consideration any expected fluctuation in raw material prices and delivery delay. We store our finished products at the warehouses.

Intellectual Property

Intellectual property rights are important to our business, and we devote significant time and resources to their development and protection. We have defined and implemented dedicated intellectual property strategies for our business. We rely on a combination of patents, trademarks, design certificates and agreements (non-disclosure and non-competition agreements) in India to protect our business and proprietary technology. All personnel involved in developing our intellectual property, including external stakeholders, are required to sign a deed of assignment and accordingly, we own all such property pursuant to the assignment.

The following table sets forth our intellectual property as on the date of this Red Herring Prospectus:

Trademark		Design certificate		Patent		Copyright	
Registered	Applied	Registered	Applied	Registered	Applied	Registered	Applied
228	50	72	28	-	7	16	6

Pursuant to a trademark license agreement dated April 29, 2015, as amended pursuant to an amendment to the trademark license agreement dated August 10, 2018, entered into with Ram Ratna Research and Holdings Private Limited, we have been granted a non-exclusive license to use certain trademarks, namely ‘RR’, ‘RR✓’ and  for a period of 14 years from April 29, 2015. Under the trademark license agreement, we are required to pay a royalty of ₹7,500 per annum.

Pursuant to a brand license agreement dated May 1, 2022 entered into with LPTPL, we have been granted a limited, exclusive, non-transferable, non-assignable and non-delegable license to use the ‘Luminous Fans and Lights’ brand for an initial period of two years subject to extension of six months at a time for a maximum of four times. In terms of the brand license agreement, out of which we paid a lump sum amount of ₹50.00 million as royalty for use of the licensed brands in the first two years. Further, we need to pay royalty of ₹50.00 million for any extension of the brand license agreement on a semi-annual basis for the remaining two years to use the licensed brands. We also have a one time right to extend the license for a period of three months and have to pay ₹25.00 million as royalty for such extension. We have adopted ‘Luminous Fans and Lights’ brand for our premium FMEG products and subsequently, aim to develop and establish our ‘RR Signature’ brand for our premium FMEG products in replacement of the ‘Luminous Fans and Lights’ brand over time through Fiscal 2024. Further, we have the right to use 61 registered trademarks, five applications for trademark registrations and 18 trademarks not yet applied to be registered with Trade Marks Registry, for an initial period of two years subject to extension of six months at a time for a maximum of four times. As on June 30, 2023, we were not subject to any material claim or legal action alleging infringement of third party owned IP. See “*Risk Factors – If we are unable to maintain and enhance our brands, including our ability to protect our brand through intellectual property, the sales of our products will suffer, which would have a material adverse effect on our results of operations. We may also unintentionally infringe upon the intellectual property rights of others, any misappropriation of which could harm our competitive position.*” on page 34.

Quality control, process safety and regulatory inspections

Our business success depends on the quality of our products, and we believe we have invested in robust manufacturing, laboratory and documentation practices. We have developed systems to ensure product quality and customer satisfaction, which are focused on providing products conforming to applicable standards, meeting customer requirements, and minimizing risks and ensuring the safety of our products. We have a quality testing laboratory for wires and cables at our Waghodia Facility that is equipped to perform incoming material inspection, in-process inspection and final inspection. Our laboratory at our Waghodia Facility can undertake several critical tests such as conductor resistance tests, circuit integrity fire tests and electrical tests such as impulse test, partial discharge, tan delta and high voltage tests. In addition, we have quality control departments at our remaining facilities which are adequately equipped for raw material testing, process monitoring and type testing of products. Our laboratory at our Waghodia Facility is equipped with automatic and semi-automatic machines for physical tests, thermal tests, endurance tests, life cycle tests and fire resistance tests. Further, we have a dedicated quality control department for quality testing switches at our Waghodia Facility.

As of June 30, 2023, our quality control team consisted of 151 employees. The members of our quality team conduct stringent quality checks on a periodic basis. In addition, our employees periodically undergo thorough training programs designed to update them on the latest quality norms and standards.

Further, each product type has its own quality assurance plan. The quality assurance plan includes sampling plan, acceptance norms, testing method and guidelines to control and monitor the performances of the product. Every stage of the process, i.e. from raw material until the finished good, is integrated and traceable on our ERP systems. Products produced by our contract manufacturers also have to adhere to our quality standards and undergo the relevant quality control systems.

We aim to ensure that our manufacturing facilities are in compliance with applicable regulatory standards. Our facilities are subject to periodic inspections from various regulatory agencies that have issued certifications. The following table sets forth the certifications obtained by us for compliance with quality standards:

Manufacturing facility	Certifications
Waghodia Facility	ISO 14001:2015, ISO 45001:2018, ISO 9001:2015, PCR from BASEC and NABL ISO/IEC 17025:2017
Silvassa Facility	ISO 14001:2015, ISO 45001:2018, ISO 9001:2015
Roorkee Facility	ISO 9001:2015
Bengaluru Facility	-
Gagret Facility	ISO 14001:2015, ISO 45001:2018 and ISO 9001:2015

Furthermore, our products have obtained the following certifications for compliance with the several quality standards specified in the table below:

Manufacturing Facility	Standard	Range of Products	Issuing Authorities
Waghodia Facility	IS 7098 : PART 2 : 2011	Crosslinked Polyethylene Insulated Thermoplastics Sheathed for working voltages from 3.3 kV up to and including 33 KV.	BIS (India)
	IS 7098 : PART 1 : 1988	Crosslinked polyethylene insulated PVC sheathed cables for working voltages up to and including 1.1 KV.	BIS (India)
	IS 694 : 2010	Polyvinyl Chloride Insulated Unsheathed And Sheathed cables cords with rigid and flexible conductor for rated voltages up to and including 1.1 KV.	BIS (India)
	IS 17048 : 2018	Halogen Free Flame Retardant (HFFR) Cables For Working Voltages Up To And Including 1.1KV Volts.	BIS (India)
	IS 1554 : PART 1 : 1988	PVC insulated (heavy duty) electric cables For working voltages up to and including 1 100 V.	BIS (India)

Manufacturing Facility	Standard	Range of Products	Issuing Authorities
	IS 17505 -1:2021	Thermosetting insulated, Fire survival cables for fixed installations having Low Emission of Smoke and Corrosive Gases when affected by Fire for Working Voltages Up to and Including 1100 Vac and 1500 Vdc	BIS (India)
	CSA 22.2	CU / TINNED CU, PVC insulated single core cable for 300V grade for use in control panel, switchgear and appliance application.	CSA (Canada)
	UL 1015	CU / TINNED CU, PVC insulated single core cable for 600V grade for use in control panel, switchgear and appliance application.	UL (USA)
	UL 1007	CU / TINNED CU, PVC insulated single core cable for 300V grade for use in non-flexing applications.	UL (USA)
	UL 1275	CU / TINNED CU, PVC insulated single core cable for 600V grade for the internal wiring of appliances, equipment for use in heating & cooling, machine tool and appliance applications.	UL (USA)
	UL 1569	CU / TINNED CU, PVC insulated single core cable for 105°C, 300V grade for use in control panel, switchgear and appliance application.	UL (USA)
	UL 11562	CU / TINNED CU, PVC insulated single core cable 105°C, 1000V	UL (USA)
	UL 2586	CU / TINNED CU, PVC insulated & PVC Sheathed multicore / Shielded / Braided cable, 105°C, 1000 V for use in public address systems, intercoms & remote-control circuit	UL (USA)
	UL 2587	CU / TINNED CU, PVC insulated & PVC Sheathed multicore / Shielded / Braided cable, 90°C, 600 V suitable for EIA RS-232 applications.	UL (USA)
	UL 2464	CU / TINNED CU, PVC insulated & PVC Sheathed multicore / Shielded / Braided cable, 80°C, 300 V for Sound broadcast, audio, instrumentation and computer cables	UL (USA)
	UL 2576	CU / TINNED CU, PVC insulated & PVC Sheathed multicore / Shielded / Braided cable, 80°C, 150 V for use in public address systems, intercoms & remote-control circuit.	UL (USA)
	UL 2598	CU / TINNED CU, PVC insulated & PVC Sheathed multicore / Shielded / Braided cable, 60°C, 300 V for use in public address systems, intercoms & remote-control circuit.	UL (USA)
	UL 3289	CU / TINNED CU, XLPE or XLPO insulated single core cable 150°C, 600 Vac, 750 Vdc for use in internal wiring of appliances, computers, test equipment.	UL (USA)
	UL 3321	CU / TINNED CU, XLPE insulated single core cable 150°C, 600 Vac, 750 Vdc for use in electric motor & generator, electronic, heating & cooling, lighting.	UL (USA)
	UL 3173	CU / TINNED CU, XLPE insulated single core cable 125°C, 600 Vac for use in electric motor & generator, switchgear, & appliance applications	UL (USA)
	UL 3271	CU / TINNED CU, XLPE insulated single core cable 125°C, 600 Vac, 750Vdc for use in internal wiring of appliances, computers, test equipment.	UL (USA)
	UL 3344	CU / TINNED CU, XLPE insulated single core cable 125°C, 600 Vac for use in Motor Leads and internal wiring.	UL (USA)

Manufacturing Facility	Standard	Range of Products	Issuing Authorities
	UL 2726	USL Battery Lead Wire for Electric Battery Powered Industrial Trucks, Rated 105°C, 150V.	UL (USA)
	BS 5467:2016	Thermosetting insulated, armoured cables of rated voltages of 600/1000 V and 1 900/3 300 V for fixed installations – Specification (CU, XLPE insulated Armoured cables PVC Sheathed for 600/1000V grade)	BASEC (UK)
	BS EN 50525-2-31:2011	Low voltage energy cables of rated voltages up to and including 450/750 V (U0/U) cables for general applications. Single core non-sheathed cables with thermoplastic PVC insulation.	BASEC (UK)
	BS EN 50525-2-11:2011	Low voltage energy cables of rated voltages up to and including 450/750V (U0/U) Cables for general applications. Flexible cables with thermoplastic PVC insulation.	BASEC (UK)
	BS 6004:2012, 6181Y	Cu Conductor, PVC insulated and PVC sheathed cables for voltages up to and including 300/500 V for electric power and lighting.	BASEC (UK)
	BS 6231:2006	Single core PVC insulated flexible cables of rated voltage 600/1000 V for switchgear and control gear wiring	BASEC (UK)
	BS EN 50525-3-41:2011	Low voltage energy cables of rated voltages up to and including 450/750 V (U0/U). Cables with special fire performance. Single core non-sheathed cables with halogen-free crosslinked insulation, and low emission of smoke	BASEC (UK)
	EN 50618, SOLAR CABLE	Tinned Copper conductor, Halogen free cross-linked compound insulated and sheathed single core PV cable (Electric cable for Photovoltaic Cable)	TUV Rheinland (Germany)
	ETL approval for Sprinkler cable	Sprinkler cables P7001D : SINGLE CORE CABLE-14 AWG TO 1/0 AWG P7002D : SINGLE CORE CABLE-18 AWG & 16 AWG P7079D : SINGLE CORE CABLE-14 AWG, 12 AWG, 10 AWG P7072D : MULTI CORE CABLE-2C X 12 AWG, 14 AWG P7183D : MULTI CORE CABLE-2C TO 25C X 18 AWG P7190D : TWIN FLAT-2C X 18 AWG TO 8 AWG P7350D & P7354D : MULTI CORE-2C X 14 AWG & 12 AWG P7313D : TWIN TWISTED-2C X 14 AWG & 12 AWG	Intertek (Etl) (USA)
	ETL approval for Irrigation Cables UL SUBJECT 1263:2001 Ed.5 For USA & CANADA	Range of Irrigation cables designed to operate electric motor driven irrigation systems. Model no: 200010, 200011, 200012, 200025, 200030, 200033, 200044, 200054 200055 200056, 200060, 200082B, 200083L	Intertek (Etl) (USA)
Silvassa Facility	DIN EN 50525-2-31 (VDE 0285-525-2-31):2012-01 ; EN 50525-2-31:2011	Low voltage energy cables of rated voltages up to and including 450/750 V (U0/U) cables for general applications. Single core non-sheathed cables with thermoplastic PVC insulation.	VDE (Germany)
	DIN EN 50525-2-11 (VDE 0285-525-2-11):2012-01 ; EN 50525-2-11:2011	Low voltage energy cables of rated voltages up to and including 450/750V (U0/U) Cables for general applications. Flexible cables with thermoplastic PVC insulation	VDE (Germany)
	IS 694:2010	Polyvinyl chloride insulated unsheathed and sheathed cables cords with rigid and flexible conductor for rated voltages up to and including 1100 V.	BIS (India)
	IS 9857:1990	Welding cables	BIS (India)

Manufacturing Facility	Standard	Range of Products	Issuing Authorities
	IS 1293:2019	Plugs and socket outlets of 250 volts and rated current up to 16 amperes - 6 A, 250 VOLTS, 16A, 250 VOLTS ac	BIS (India)
	IS 17048:2018	Halogen Free Flame Retardant (HFFR) Cables For Working Voltages Up To And Including 1.1KV Volts	BIS (India)
Bengaluru Facility	IS 10322 (PART 5/Sec 1) : 2012	Fixed General Purpose LED Luminaries	BIS (India)
	IS 10322 (PART 5/SEC 2) : 2012	Recessed LED Luminaires	BIS (India)
	IS 10322 (PART 5/Sec 1) : 2012	Lineage Led Channel Light Series (Fixed General Purpose Led Luminaires)	BIS (India)
	IS 10322 (PART 5/Sec 5) : 2013	LED Flood Lights	BIS (India)
	IS 10322 (PART 5/Sec 1) : 2012	GS + Clean Room (Fixed General Purpose LED Luminaries)	BIS (India)
	IS 10322 (PART 5/Sec 1) : 2012	Stealth Series (Fixed General Purpose LED Luminaries)	BIS (India)
Gagret Facility	BEE Label	Electric Ceiling Type Fans	Bureau of Energy Efficiency
Roorkee Facility	IS 374:2019	Electric Ceiling Type Fans	BIS (India)
	BEE Label	Electric Ceiling Type Fans	Bureau of Energy Efficiency
	CE Certification (2014/35/EU and 2014/30/EU)-Certificate No. 11846	Ceiling Fan	UK Certification and Inspection Limited
	CB Certification (2014/35/EU and 2014/30/EU)	Ventilation group fan	IEC
	Gulf Type Examination certificate	Ceiling Fan	Bureau Veritas Saudi Arabia Testing Services
	EMI/EMC test Report	Ceiling Fan	AA Electro Magnetic Test Laboratory P. Ltd.
	CE Certification (2014/35/EU and 2014/30/EU)-Certificate No. 2188	Ceiling Fan	UK Certification and Inspection Limited
Name of Certification	Range of products	Issuing Authority	
Type Test Report	HT XLPE Cables from 3.3 kV to 33 kV Voltage Grade as per IS 7098 Part-2:2011	Electronic Research and Development Association ("ERDA"), Vadodara, India	

Manufacturing Facility	Standard	Range of Products	Issuing Authorities
Type Test Report	LT XLPE Cables up to and including 1.1 kV as per IS 7098	ERDA, Vadodara, India; Central Power Research Institute (“CPRI”), Bengaluru, India	
Type Test Report	LT PVC Cables up to and including 1.1 kV as per IS 1554	ERDA, Vadodara, India	
Type Test Report	1 kV to 30 kV Power Cables as per IEC 60502-1 and 2	TUV Rheinland (India) Private Limited.	
Type Test Report	PVC wires up to and including 1.1 kV as per IS 694:2010	ERDA, Vadodara, India	
Type Test Report	Halogen Free Flame-Retardant Cables/cords up to and including 1.1 kV as per IS 17048:2018	ERDA, Vadodara, India	
CWZ Test Report	Fire Survival Cables- BS 7846:2009	ERDA, Vadodara, India	

As a result, our manufacturing facilities are subjected to system audits and product accreditation audits by these entities. In addition, we have customer inspections and audits on a periodic basis. In addition, we conduct regular repair and maintenance programs for our manufacturing facilities and our engineers and technicians periodically inspect our manufacturing facilities.

Research and Development

We place a strong focus on research and development, aimed at further expanding our product portfolio in our focus areas and selectively entering adjacent areas. As at June 30, 2023, we have one dedicated R&D center in Waghodia which is NABL ISO/IEC 17025:2017 certified and recognized by the Department of Scientific and Industrial Research, Ministry of Science and Technology, Government of India, a dedicated team of 60 employees focused on research and development, of which 22 employees exclusively work on research and development involving FMEG products. We also carry out R&D at our manufacturing facilities. As of June 30, 2023, we had 15 and 55 products under development for wires and cables and FMEG segments, respectively, of which no products under wires and cables segment and 12 products under FMEG segment have been launched as of the date of this Red Herring Prospectus. In addition, we intend to start manufacturing other raw materials such as thermoset e-beamable LS0H compound in Fiscal 2024. As of the date of this Red Herring Prospectus, we have conducted various procedures to develop such manufacturing capabilities, including fine-tuning the formulation design, checking the commercial viability and selecting and procuring the raw materials.

Our product development initiatives are focused on meeting the requirements of our customers by identifying their needs and addressing the gaps in market relating to our focus areas. Our product development is driven by our cross-functional team which regularly engages with our customers and key opinion leaders. We undertake the following research and development activities: (i) product evaluation; (ii) process development including feasibility studies, laboratory validation and development history reports; (iii) process scale up and validation; and (iv) regulatory filings and approvals.

Through our R&D efforts, we have developed features and products such as FIREX LS0H, unilay core technology (heat resistant and flame retardant) products. The following table sets out the number of products launched for the periods indicated:

Type of product launched	Fiscals			Three months ended June 30,	
	2021	2022	2023	2022	2023
Wires and cables	12	19	13	2	6
FMEG	116	153	75	13	28

Environmental, health and safety and sustainability initiatives

We aim to comply with applicable health and safety regulations and other requirements in our operations. We aim to minimize the adverse impact of our products and activities on the environment, maintain ecological balance and protect the bio-diversity near our manufacturing facilities. Further, we aim to comply with the legislative requirements, requirements of our licenses, approvals, and various certifications and ensure the safety of our employees and people working in our manufacturing facilities or under our management. For further details, see “Government and Other Approvals” on page 407.

We formed a monitoring committee comprising our senior management and a core committee of senior executives which oversee the timely roll out of environmental initiatives across the organization, and report to the monitoring committee. We have also engaged a specialized services firm, Envint Services LLP to help us devise our environmental strategy and implementation plan. Such initiatives and strategies include a systematic analysis and control of risks by providing appropriate training to our management and our employees. We have implemented work safety measures to ensure a safe working environment at our facilities.

Our Waghodia, Silvassa and Gagret Facilities are certified as conforming to ISO 45001:2018 and ISO 14001:2015 for occupational health and safety management systems and environmental management systems, respectively.

We undertake various initiatives to address environmental issues such as climate change and global warming. We have adopted “zero” waste discharge initiatives wherein no untreated effluent from our manufacturing operations is discharged on to the land or into any water body. As on June 30, 2023, we have installed (i) three sewage treatment plants with each having an installed capacity of 75 kilo liter per day, one effluent treatment plant having an installed capacity of 10 kilo liter per day at our Waghodia Facility; (ii) three sewage treatment plants with an installed capacity of 230 kilo liter per day and one effluent treatment plant of 10 kilo liter per day at our Silvassa Facility. The treated water is utilized for horticulture and restrooms. Our Waghodia Facility also has rain water harvesting mechanism, which allows us to use 34% rainwater received in the factory catchment area to recharge ground water, as of June 30, 2023. In addition, we have adopted the use of clean energy in our facilities. Our Waghodia and Silvassa Facilities have an installed rooftop capacity of 1.2 MW and 0.25 MW, respectively, for solar energy. Further, we purchase electricity from an offsite hybrid solar and wind plant with an installed capacity of 3.82 MW for our Waghodia Facility. These constitute 59% and 5% of the contracted demand for electricity for our Waghodia and Silvassa Facilities, respectively, as of June 30, 2023.

We were the first company in India to launch products compliant with European regulations such as REACH, ROHS and CPR. (Source: Technopak Report) We also sell green BLDC fans. These fans are energy efficient and all components such as motor box, plastic, binding mechanism and artwork ink are all made up of green products such as pulp tray, biodegradable inks and cotton threads.

Awards and accreditations

Over the years we have won several awards and accolades. For further details, see “History and Certain Corporate Matters – Awards, accreditations and recognitions received by our Company” on page 238.

Insurance

Our operations are subject to various risks inherent in the manufacturing industry, as well as theft, natural disasters, spread of communicable diseases, acts of terrorism and other unforeseen events. Accordingly, we have obtained insurance policies in relation to plant and machinery, burglary, stocks and finished goods. In addition, we have also obtained directors’ and officers’ liability insurance. The following table sets forth details of our insurance coverage in Fiscals 2021, 2022 and 2023 and three months ended June 30, 2023:

(in ₹ millions, unless specified otherwise)

	As on March 31, 2021		As on March 31, 2022		As on March 31, 2023		As on June 30, 2023	
	Insured Tangible Assets	Uninsured / Under-insured Tangible Assets	Insured Tangible Assets	Uninsured / Under-insured Tangible Assets	Insured Tangible Assets	Uninsured / Under-insured Tangible Assets	Insured Tangible Assets	Uninsured / Under-insured Tangible Assets
Amount of Tangible Assets*	5,348.28	74.54	5,638.95	118.49	6,644.65	160.29	6,850.84	51.51
Amount of Insurance Obtained	5,500.09	-	6,201.58	-	6,874.23	-	7,359.59	-
% of Total Tangible Assets	98.63%	1.37%	97.94%	2.06%	97.64%	2.36%	99.25%	0.75%
Insurance Coverage	102.84%	-	109.98%	-	103.46%	-	107.43%	-

* Tangible Assets value reported at gross value, excluding details of vehicles which is approximately 2.94% of total tangible assets of the Company (in value terms) as on June 30, 2023.

* Amount (in ₹ million) denotes Gross value of assets, not written down value

See “Risk Factors – Our insurance coverage may not be adequate to protect us against all potential losses, which may have a material adverse effect on our business, financial condition, cash flows and results of operations.” on page 40.

Employees

We employed 2,388, 2,547 and 3,036 personnel as of March 31, 2021, 2022 and 2023. As of June 30, 2023, our Company employed 3,108 personnel, of which 305 personnel have engineering degrees across several verticals within the organization. In addition to our full-time employees, we frequently hire workers on a contractual basis, largely at our manufacturing facility and for our sales. The breakdown of our Company’s permanent employees in different functionalities as of June 30, 2023 has been provided below:

Function	Number of employees
Accounts and finance	91
Administration	254
Human resources	37
Information technology	23
Manufacturing	1,703
Research and development	60
Sales and marketing	789
Technical cell	151
Total	3,108

We have a diverse and inclusive workforce and our employees have been previously employed by organizations and multinational corporations in various industries. We train our employees on a regular basis to upgrade the level of operational excellence, improve productivity and maintain compliance standards on quality and safety. We offer equity linked incentives that align with the interests of our employees with shareholders. For further details, see “Our Management” on page 243. Further, we offer relevant benefits to our employees, and regularly conduct employee engagement programs across our facilities and teams.

The attrition rate for our employees for Fiscals 2021, 2022 and 2023 and the three months ended June 30, 2022 and June 30, 2023 was 10.96%, 15.36%, 15.98%, 3.54% and 3.55%, respectively.

We engage independent contractors through whom we engage contract labor for our manufacturing facilities and warehouses. These contract laborers carry our functions such as production, loading, packing and security services. Our employees typically carry out supervisory functions at our facilities. The contracts with the contractors are typically for a fixed term and allow for renewal and termination, and include particular clauses which require the contractors to adhere to various compliance matters. We further collect evidence in support of such compliances on the contract workers provided by each contractor to ensure that they satisfy the requirements of local labor laws.

In Fiscal 2017, certain of our employees in our Waghodia Facility went on strike to protest the decision to terminate employment with certain unionized works and contractors, which partially affected our production at such facility for approximately a week. For further details, see “Risk Factors – We operate in a labor-intensive industry and are subject to stringent labor laws and any strike, work stoppage or increased wage demand by our employees or any other kind of disputes with our employees could adversely affect our business, financial condition, results of operations and cash flows.” on page 46. We have not experienced any strike, work stoppage, labor dispute in Fiscals 2021, 2022 and 2023 and three months ended June 30, 2022 and 2023.

As a part of our efforts to resolve the strike at our Waghodia Facility in 2017, we have previously entered into memorandum of settlement with the Waghodia Union in relation to the standard of wage and other corporate benefits for our unionized employees at Waghodia Facility. Such memorandum of settlement usually has a term of three years and is periodically renewed. Our latest memorandum of settlement with the Waghodia Union is dated March 6, 2023 (the “**2023 Waghodia Union Agreement**”), with a term of three years, from April 1, 2022 to March 31, 2025. Pursuant to the 2023 Waghodia Union Agreement, we agreed with the permanent unionized company workmen and the fixed term trainee workmen at Waghodia Facility to, among other things, provide pre-agreed basic wage and certain allowances, including education allowance, house rent allowance on a monthly basis and quarterly performance-based bonus based on the grade of unionized workers, and other customary benefits. We agreed to increase the wage level and monthly settlement amount and introduced the quarterly performance based bonus to better incentivize our unionized workers at our Waghodia Facility. In exchange, the unionized workers agreed to adhere to a matrix of performance standards.

Competition

The Indian wires and cables industry is fragmented in nature. The Indian wires and cables industry has been gradually moving from a largely unbranded play towards branded play including regional and national players as a result of rising awareness among consumers towards safety and quality, the advent of the GST regime, increasing technological and product complexities, as well as growing marketing and branding activities by branded players. Some of our competitors may have greater resources than those available to us.

The wires and cables and fast moving electrical good industries are highly competitive with the presence of many national and regional players (manufacturers, traders, suppliers and importers etc.), competing on the basis of factors such as products, price, customer service, post sales services, quality and delivery. (Source: *Technopak Report*) For details on the competitive landscape, see “*Industry Overview*” on page 139.

Information Technology

We have also invested in technological tools such as Microsoft D365, SAP S4/ HANA ERPs, enterprise data warehouse and digitized human resources information system. These systems facilitate the flow of real-time information across departments and allows us to make information driven decisions and manage performance.

We have automated certain aspects of our sales force such as field assist and have also adopted a differentiated technology framework and implement a combination of digital and physical initiatives for customer origination and marketing, as well as partner management. Our partner loyalty program, RR Connect, includes a mobile phone application and web portal. This mobile application has helped us to track user-wise tertiary sales and primarily incentivize them through initiatives such as loyalty tier upgrades and long-term reward bonus points. It provides insights on which products are being sold in specific geographical areas, helps us streamline our marketing and sales initiatives. We also use solutions such as multi factor authentication for email, cloud and Microsoft D365 ERP access, end point detection and response based end-point protection, advanced threat protection for email protection and zero trust network access based secure access to business-critical applications, to ensure cybersecurity. We have adopted an Information Systems’ Acceptable Use Policy and train our employees on a regular basis to maintain compliance standards on cyber security and information security. Our business-critical applications are on SaaS platforms, and are hosted on Azure cloud, which provides us backup and disaster recovery capabilities. We have also set up a scalable enterprise data warehouse, with various dashboards to provide insights to our management for decision making.

Corporate social responsibility initiatives

We have adopted a corporate social responsibility (“CSR”) policy in compliance with the requirements of the Companies Act, 2013 and the Companies (Corporate Social Responsibility) Rules, 2014. Our CSR initiatives are part of our overall strategy of developing communities and environmental sustainability, as well as creating a protected future for the generations to come. In order to achieve this, our CSR initiatives are aimed towards promoting education, gender equality and female empowerment, and ensuring environmental sustainability. In addition, our Kabel Star Scholarship Program has disbursed scholarships of ₹10 million to over 1,000 children of our partner electricians, to empower them in their education. Under our Mission Rroshni, we have developed various initiatives for education (such as One Teacher School and construction of rural employment training center building in Jarangloi, Odisha), female empowerment and healthcare.

Properties

Our Registered Office is located at Ram Ratna House, Victoria Mill compound, Pandurang Budhkar Marg, Worli, Mumbai 400 013, Maharashtra, India. Our Corporate Office is located at Alembic Business Park (W), Ground Floor, Bhailal Amin Marg, Gorwa, Vadodara 390 003, Gujarat, India. Our Registered Office is on a leave and license basis for a period of three years starting from March 31, 2022.

As on June 30, 2023, we operate our Waghodia, Silvassa and Roorkee Facilities on lands held by us on freehold basis. The title deeds to our Roorkee Facility and the underlying freehold land are held in the name of Ram Ratna Electricals Limited, an entity that was amalgamated with our Company with effect from April 1, 2019 pursuant to the Scheme of Amalgamation 2020. For further details, see “*History and Certain Corporate Matters - Details regarding material acquisitions or divestments of business/undertakings, mergers, amalgamation, any revaluation of assets, etc. in the last 10 years – Scheme of Amalgamation 2020*” on page 238. Our Bengaluru and Gagret Facilities are operating on parcels of land that are held by us on leasehold basis and the following table sets forth the details of leases entered into by us for our manufacturing facilities:

Manufacturing Facility	Current Lease Start (Month/Year)	Lease Term in Years	Lessor(s)	Lease Payments	Plot Size (In Sq. meter)
Bengaluru Facility: 140, 4th Phase, Bommasandra Industrial Area, Bengaluru, Karnataka, 560099	March 25, 2023	One year	T. Venkateswara Rao	Fiscal 2021: ₹ 1.21 million Fiscal 2022: ₹ 1.42 million Fiscal 2023: ₹ 1.49 million Three months ended June 30, 2022: ₹ 0.37 million Three months ended June 30, 2023: ₹ 0.39 million	557 sq. mts.
Gagret Facility: Khasra No 944,946,947,949 To 975, Upmohal Dev Nagar, Mauza Gagret, Sub-Tehsil Gagret at Kaloh, District Una, Himachal Pradesh, 177 201	April 1, 2022	10 years	Chander Sharma, Neelam Sharma, Ashok Kumar Sharma and Shashi Kanta	Fiscal 2023: ₹ 17.12 million Three months ended June 30, 2022: ₹ 3.11 million Three months ended June 30, 2023: ₹ 4.67 million	17,349 sq. mts.

Our Company has 21 warehouses as on June 30, 2023. Premises on which our warehouses and other offices are located are either owned by us, or held either on a leasehold or under a leave and license basis.

For further details, see “*Risk Factors – Certain of our manufacturing properties are located on leasehold lands. If we are unable to renew existing leases or relocate our operations on commercially reasonable terms, there may be a material adverse effect on our business, financial condition and operations. Certain of our warehouses are not registered in our name, which could have a material adverse effect on our business financial condition and operations.*” on page 55.

Significant developments after June 30, 2023

For further details in relation to significant developments after June 30, 2023, see “*Management’s Discussion and Analysis of Financial Condition and Results of Operations*” on page 379.

KEY REGULATIONS AND POLICIES

The following description is a summary of certain key statutes, rules, regulations, notifications, memorandums, circulars and policies which are applicable to the business and operations of our Company. For details of government approvals obtained by our Company, see “Government and Other Approvals” beginning on page 407.

The information detailed in this section, is based on the current provisions of applicable statutes, rules, regulations, notifications, memorandums, circulars and policies which are subject to amendments, changes and/or modifications by subsequent legislative, regulatory, administrative or judicial decisions. The information in this section has been obtained from publications available in the public domain. The description of the applicable regulations as given below has been provided in a manner to provide general information to the investors and may not be exhaustive and is neither designed nor intended to be a substitute for professional legal advice.

Key Legislations Applicable to our Company

Bureau of Indian Standards Act, 2016 (“Bureau of Indian Standards Act”)

The Bureau of Indian Standards Act establishes, publishes and regulates national standards to ensure conformity assessment, standardisation, and quality assurance of goods, articles, processes, systems and services. The Bureau of Indian Standards Act provides for the establishment of a bureau for the standardization, marking and quality certification of goods. The Bureau of Indian Standards Act provides for the functions of the bureau which include, among others (a) adopting as Indian standard, any standard established for any goods, article, process, system or service by any other institution in India or elsewhere; (b) specifying a standard mark to be called the Bureau of Indian Standards Certification Mark which shall be of such design and contain such particulars as may be prescribed to represent a particular Indian standard; and (c) making such inspection and taking such samples of any material or substance as may be necessary to see whether any goods, article, process, system or service in relation to which the standard mark has been used conforms to the relevant standard or whether the standard mark has been properly used in relation to any goods, article, process, system or service with or without a license. Further, the Bureau of Indian Standards Act sets out, *inter alia*, liability for use of standard mark on products that do not conform to the relevant Indian Standard.

Bureau of Indian Standards Rules, 2018 (“Bureau of Indian Standards Rules”)

The Bureau of Indian Standards Rules have been notified, in supersession of the Bureau of Indian Standards Rules, 1987, in so far as they relate to Chapter IV A of the said rules relating to registration of the articles notified by the Central Government, and in supersession of the Bureau of Indian Standards Rules, 2017 except in relation to things done or omitted to be done before such supersession. Under the Bureau of Indian Standards Rules, the bureau is required to establish Indian standards in relation to any goods, article, process, system or service and shall reaffirm, amend, revise or withdraw Indian standards so established as may be necessary.

Electronics and Information Technology Goods (Requirement of Compulsory Registration) Order, 2021 (“Compulsory Registration Order”)

The Compulsory Registration Order has been notified in supersession of the Electronics and Information Technology Goods (Requirement of Compulsory Registration) Order, 2012. The Compulsory Registration Order states that the manufacturing, storage, import, sale or distribution of goods, which do not meet the specified standard and/or bear a self-declaration confirming conformance to the relevant Indian standard is prohibited. Such goods shall also bear the “standard mark” under a license from the Bureau of Indian Standards in accordance with the Bureau of Indian Standards (Conformity Assessment) Regulations, 2018. The only exception is for those goods or articles which are meant for export which conform to the specification required by the foreign buyer and to goods or articles, for which the Central Government has issued a specific exemption letter, based on reasons to be recorded in writing.

The Electrical Wires, Cables, Appliances and Protection Devices and Accessories (Quality Control) Order, 2003 (the “Quality Control Order”)

The Quality Control Order prohibits the manufacture, storage for sale, sale and distribution of electrical wires, cables, appliances, protection devices (including low voltage switchgear and fuses) that do not conform to the standards specified in such order and that do not bear the standard mark issued by the BIS. The Quality Control Order directs a manufacturer of electric wires, cables and protection devices, amongst others, to commence manufacture of such electric equipment only after obtaining a license from the BIS for the use of standard mark. Further, it requires any sub-standard or defective electrical wires, cables, appliances, protection devices or accessories to be deformed by such manufacturer beyond use and disposed of as scrap. The Central Government is authorized to appoint an officer who is empowered to require any person engaged in the

manufacture, storage, sale or distribution of electrical equipment to furnish information and samples in relation to the electric equipment manufactured, stored, sold or distributed, as the case may be, inspect any books or documents and search any premises and seize electric equipment in case of contravention of the Quality Control Order.

Legal Metrology Act, 2009 (“Metrology Act”) and Legal Metrology (Packaged Commodities) Rules, 2011

The Metrology Act was enacted with the objectives to establish and enforce standards of weights and measures, regulate trade and commerce in weights, measures and other goods which are sold or distributed by weight, measure or number and for matters connected therewith or incidental thereto. The Metrology Act states that any transaction/contract relating to goods/class of goods or undertakings shall be as per the weight/measurement/numbers prescribed by the Metrology Act. The specifications with respect to the exact denomination of the weight of goods to be considered in transactions are contained in rules issued by each state.

The Legal Metrology (Packaged Commodities) Rules, 2011, framed under the Metrology Act lays down specific provisions applicable to packages intended for retail sale, wholesale packages and for export and import of packaged commodities and also provides for registration of manufacturers and packers. The said rules also lays down specific provisions for e-commerce transactions and online sale of packaged commodities.

National Policy on Electronics, 2019 (“NPE, 2019”)

The NPE, 2019 envisions positioning India as a global hub for Electronics System Design and Manufacturing - (ESDM) by encouraging and driving capabilities in the country for developing core components, including chipsets, and creating an enabling environment for the industry to compete globally. The NPE, 2019 replaces the National Policy of Electronics 2012. The NPE, 2019 when implemented will lead to formulation of several schemes, initiatives, projects, etc., in consultation with the concerned ministries/ departments, for the development of the ESDM sector in the country. It will enable flow of investment and technology, leading to higher value addition in the domestically manufactured electronic products, increased electronics hardware manufacturing in the country and their export, while generating substantial employment opportunities.

Labour law legislations

The employment of workers, depending on the nature of activity, is regulated by a wide variety of generally applicable labour laws. The following is an indicative list of labour laws which may be applicable to our Company due to the nature of our business activities:

The Factories Act, 1948 (“Factories Act”)

The term ‘factory’, as defined under the Factories Act, includes any premises which employs or has employed on any day in the previous 12 months, 10 or more workers and in which any manufacturing process is carried on with the aid of power, or any premises wherein 20 or more workmen are employed at any day during the preceding 12 months and in which any manufacturing process is carried on without the aid of power or is ordinarily so carried on. State Governments have issued rules in respect of the prior submission of plans and their approval for the establishment of factories and registration and licensing of factories. The Factories Act mandates the ‘occupier’ of a factory to ensure the health, safety and welfare of all workers in the factory premises. Further, the ‘occupier’ of a factory is also required to ensure (i) the safety and proper maintenance of the factory such that it does not pose health risks to persons in the factory premises; (ii) the safe use, handling, storage and transport of factory articles and substances; (iii) provision of adequate instruction, training and supervision to ensure workers’ health and safety; and (iv) cleanliness and safe working conditions in the factory premises. If there is a contravention of any of the provisions of the Factories Act or the rules framed thereunder, the occupier and manager of the factory may be punished with imprisonment or with a fine or with both.

Other labour related legislations

Depending upon the nature of the activity undertaken by us, the applicable labour enactments other than state-wise shops and establishments acts includes the following:

- The Apprentices Act, 1961;
- The Contract Labour (Regulation and Abolition) Act, 1970;
- The Employee’s Compensation Act, 1923;
- The Employees’ (Provident Funds and Miscellaneous Provisions) Act, 1952;

- Inter-State Migrant Workmen (Regulation of Employment and Conditions of Service) Act, 1979;
- The Payment of Gratuity Act, 1972;
- The Payment of Bonus Act, 1965;
- The Maternity Benefit Act, 1961;
- The Minimum Wages Act, 1948;
- The Employees' State Insurance Act, 1948;
- The Payment of Wages Act, 1936;
- The Industrial Disputes Act, 1947;
- The Trade Unions Act, 1926;
- Industrial Employment (Standing Orders) Act, 1946;
- Employment Exchange (Compulsory Notification of Vacancies) Act, 1959
- The Sexual Harassment of Women at Workplace (Prevention, Prohibition and Redressal) Act, 2013;
- The Interstate Migrant Workmen Act, 1979;
- The Equal Remuneration Act, 1976; and
- The Child Labour (Prohibition and Regulation) Act, 1986.

In order to rationalize and reform labour laws in India, the Government of India has notified four labour codes which are yet to come into force as on the date of this Red Herring Prospectus, namely, (i) the Code on Wages, 2019 which will repeal the Payment of Bonus Act, 1965, Minimum Wages Act, 1948, Equal Remuneration Act, 1976 and the Payment of Wages Act, 1936, (ii) the Industrial Relations Code, 2020 which will repeal the Trade Unions Act, 1926, Industrial Employment (Standing Orders) Act, 1946 and Industrial Disputes Act, 1947, (iii) the Code on Social Security, 2020 which will repeal certain enactments including the Employee's Compensation Act, 1923, the Employees' State Insurance Act, 1948, the Employees' Provident Funds and Miscellaneous Provisions Act, 1952, Maternity Benefit Act, 1961, Employment Exchanges (Compulsory Notification of Vacancies) Act, 1959 and the Payment of Gratuity Act, 1972 and (iv) the Occupational Safety, Health and Working Conditions Code, 2020 which will repeal certain enactments including the Factories Act, 1948, Motor Transport Workers Act, 1961 and the Contract Labour (Regulation and Abolition) Act, 1970.

Certain portions of the Code on Wages, 2019 and Code on Social Security, 2020, have come into force upon notification by the Ministry of Labour and Employment. The remaining provisions of these codes shall become effective as and when notified by the Government of India.

Environmental laws

The Environment (Protection) Act, 1986 ("EPA")

The EPA has been enacted for the protection and improvement of the environment. It stipulates that no person carrying on any industry, operation or process shall discharge or emit or permit the discharge or emission of any environmental pollutant in excess of such standards as may be prescribed. Further, no person shall handle or cause to be handled any hazardous substance except in accordance with such procedure and after complying with such safeguards as may be prescribed. EPA empowers the Central Government to take all measures necessary to protect and improve the environment such as laying down standards for emission or discharge of pollutants, providing for restrictions regarding areas where industries may operate and generally to curb environmental pollution.

Water (Prevention and Control of Pollution) Act, 1974 ("Water Act")

The Water Act aims to prevent and control water pollution and to maintain or restore wholesomeness of water. The Water Act provides for one central pollution control board, as well as state pollution control boards, to be formed to implement its provisions, including enforcement of standards for factories discharging pollutants into water bodies. Any person intending to

establish any industry, operation or process or any treatment and disposal system likely to discharge sewage or other pollution into a water body, is required to obtain the consent of the relevant state pollution control board by making an application.

Air (Prevention and Control of Pollution) Act, 1981 (“Air Act”)

The Air Act aims to prevent, control and abate air pollution, and stipulates that no person shall, without prior consent of the relevant state pollution control board, establish or operate any industrial plant which emits air pollutants in an air pollution control area. Such person also cannot discharge or cause or permit to be discharged the emission of any air pollutant in excess of the standards laid down by the State Boards. The central pollution control board and the state pollution control boards constituted under the Water Act perform similar functions under the Air Act as well. Pursuant to the provisions of the Air Act, any person establishing or operating any industrial plant within an air pollution control area, must obtain the consent of the relevant state pollution control board prior to establishing or operating such industrial plant.

Hazardous and Other Wastes (Management and Transboundary Movement) Rules, 2016 (“Hazardous Waste Rules”) as amended by the Hazardous and Other Wastes (Management and Transboundary Movement) Amendment Rules, 2022

The Hazardous Waste Rules regulate the management, treatment, storage and disposal of hazardous waste by imposing an obligation on every occupier and operator of a facility generating hazardous waste to dispose of such waste without harming the environment. The term “*hazardous waste*” has been defined in the Hazardous Waste Rules and any person who has, control over the affairs of the factory or the premises or any person in possession of the hazardous waste has been defined as an “*occupier*”. Every occupier and operator of a facility generating hazardous waste must obtain authorization from the relevant state pollution control board. Further, the occupier, importer or exporter is liable for damages caused to the environment resulting from the improper handling and disposal of hazardous waste and must pay any financial penalty that may be levied by the respective state pollution control board.

In addition to the above-mentioned environmental laws, following is an indicative list of the environmental laws which may be applicable to our Company due to the nature of the business activities:

- Plastic Waste Management Rules, 2016;
- Bio-medical Waste management Rules, 2016;
- E-waste (Management) Rules, 2016;
- Ozone Depleting Substances (Regulation and Control) Rules, 2000;
- Noise Pollution (Regulation and Control) Rules, 2000, as amended; and
- Gas Cylinders Rules, 2016.

Further, the Ministry of Environment, Forest and Climate Change, Government of India has also notified the E-Waste (Management) Rules, 2022, which shall come into effect on April 1, 2023.

Tax laws

In addition to the aforementioned material legislations which are applicable to our Company, some of the tax legislations that may be applicable to the operations of our Company include:

- Income-tax Act 1961, the Income-tax Rules, 1962, as amended by the Finance Act in respective years;
- Central Goods and Services Tax Act, 2017, the Central Goods and Services Tax Rules, 2017 and various state-wise legislations made thereunder;
- The Integrated Goods and Services Tax Act, 2017 and rules thereof;
- Professional tax-related state-wise legislations;
- Indian Stamp Act, 1899 and various state-wise legislations made thereunder; and
- Customs Act, 1962.

Foreign Investment Laws

The Foreign Trade (Development and Regulation) Act, 1992 and the rules framed thereunder (“FTA”)

The FTA is the main legislation concerning foreign trade in India. The FTA, read along with the Foreign Trade (Regulation) Rules, 1993, provides for the development and regulation of foreign trade by facilitating imports into, and augmenting exports from, India and for matters connected therewith or incidental thereto. It authorizes the government to formulate as well as announce the export and import policy and to keep amending the same on a timely basis. The government has also been given a wide power to prohibit, restrict and regulate the exports and imports in general as well as specified cases of foreign trade. The FTA read with the Foreign Trade Policy, 2023, prohibits anybody from undertaking any import or export except under an importer-exporter code (“**IEC**”) number granted by the Director General of Foreign Trade. Hence, every entity in India engaged in any activity involving import/export is required to obtain an IEC unless specifically exempted from doing so. The IEC shall be valid until it is cancelled by the issuing authority. An IEC number allotted to an applicant is valid for all its branches, divisions, units and factories. Failure to obtain the IEC number shall attract penalty under the FTA.

The Foreign Exchange Management Act, 1999 (“FEMA”) and regulations framed thereunder

Foreign investment in India is governed primarily by the provisions of the FEMA, and the rules, regulations and notifications thereunder, as issued by the RBI from time to time and the FEMA Rules and the Consolidated FDI Policy. In terms of the Consolidated FDI Policy, foreign investment is permitted (except in the prohibited sectors) in Indian companies either through the automatic route or the Government route, depending upon the sector in which the foreign investment is sought to be made. In terms of the Consolidated FDI Policy, the work of granting government approval for foreign investment under the Consolidated FDI Policy and FEMA has now been entrusted to the concerned administrative ministries/departments.

The FEMA Rules were enacted on October 17, 2019 in supersession of the Foreign Exchange Management (Transfer or Issue of Security by a Person Resident Outside India) Regulations, 2017, except for things done or omitted to be done before such supersession. The total holding by any individual NRI, on a repatriation basis, shall not exceed five percent of the total paid-up equity capital on a fully diluted basis or shall not exceed five percent of the paid-up value of each series of debentures or preference shares or share warrants issued by an Indian company and the total holdings of all NRIs and OCIs put together shall not exceed 10% of the total paid-up equity capital on a fully diluted basis or shall not exceed 10% of the paid-up value of each series of debentures or preference shares or share warrant. Provided that the aggregate ceiling of 10 percent may be raised to 24 percent if a special resolution to that effect is passed by the general body of the Indian company.

The total holding by each FPI or an investor group, shall be less than 10 percent of the total paid-up equity capital on a fully diluted basis or less than 10 percent of the paid-up value of each series of debentures or preference shares or share warrants issued by an Indian company and the total holdings of all FPIs put together, including any other direct and indirect foreign investments in the Indian company permitted under these rules, shall not exceed 24 per cent of paid-up equity capital on a fully diluted basis or paid-up value of each series of debentures or preference shares or share warrants. The said limit of 10 percent and 24 percent shall be called the individual and aggregate limit, respectively.

With effect from April 1, 2020, the aggregate limit shall be the sectoral caps applicable to Indian companies as laid out in paragraph 3(b) of Schedule I of FEMA Rules, with respect to paid-up equity capital on fully diluted basis or such same sectoral cap percentage of paid-up value of each series of debentures or preference shares or share warrants. Further, in accordance with Press Note No. 4 (2020 Series), dated October 15, 2020 issued by the DPIIT, all investments by entities of a country which shares land border with India or where the beneficial owner of an investment into India is situated in or is a citizen of any such country, will require prior approval of the Government of India, as prescribed in the Consolidated FDI Policy.

Subject to compliance with all applicable Indian laws, rules, regulations, guidelines and approvals in terms of Regulation 21 of the SEBI FPI Regulations, an FPI, may issue, subscribe to or otherwise deal in offshore derivative instruments (as defined under the SEBI FPI Regulations as any instrument, by whatever name called, which is issued overseas by a FPI against securities held by it in India, as its underlying) directly or indirectly, only in the event (i) such offshore derivative instruments are issued only by persons registered as Category I FPIs; (ii) such offshore derivative instruments are issued only to persons eligible for registration as Category I FPIs; (iii) such offshore derivative instruments are issued after compliance with ‘know your client’ norms as specified by SEBI; and (iv) such other conditions as may be specified by SEBI from time to time.

Intellectual property laws

Certain laws relating to intellectual property rights under the Trade Marks Act, 1999, the Copyright Act, 1957 and the Patents Act, 1970 are applicable to us.

Trade Marks Act, 1999 (“Trade Marks Act”)

A trade mark is essentially any mark capable of being represented graphically and distinguishing goods or services of one person from those of others and includes a device, brand, heading, label, ticket, name, signature, word, letter, numeral, shape of goods, packaging or combination of colours or any combination thereof. In India, trademarks enjoy protection under both statutory and common law. Registration of a trade mark grants the owner a right to exclusively use the trade mark as a mark of goods and services and prevents the fraudulent use of marks in India. The Trade Marks Act permits the registration of trade marks for goods and services. Certification trademarks and collective marks can also be registered under the Trade Marks Act. The Registrar of Trade Marks is the authority responsible for, among other things, registration of trade marks, settling opposition proceedings and rectification of the register of trade marks. The Trade Marks (Amendment) Act, 2010 has been enacted to cover Indian nationals as well as foreign nationals to secure simultaneous protection of trade marks in other countries. The Trade Marks (Amendment) Rules, 2013 were enacted to give effect to the Trade Mark (Amendment) Act, 2010.

The Patents Act, 1970 (“Patents Act”)

The Patents Act governs the patent regime in India. A patent is an intellectual property right relating to inventions and grant of exclusive right, for limited period, provided by the Government to the patentee, for excluding others from making, using, selling and importing the patented product or process or produce that product. In addition to the broad requirement that an invention must satisfy the requirements of novelty, utility and non-obviousness in order for it to avail patent protection, the Patents Act further provides that patent protection may not be granted to certain specified types of inventions and materials even if they satisfy the above criteria.

The Copyright Act, 1957

The Copyright Act, 1957, along with the Copyright Rules, 2013 (“**Copyright Laws**”) governs copyright protection in India. A registration under the Copyright Laws acts as a prima facie evidence of the particulars entered therein and helps expedite infringement proceedings and reduce delay caused due to evidentiary considerations. The Copyright Laws prescribe a fine, imprisonment or both for violations, with enhanced penalty on second or subsequent convictions.

Designs Act, 2000 (“DA”) and the Designs Rules, 2001 (“DR”)

The DA regulates and protects the originality of an article’s design and prohibits the piracy of registered designs. The primary objective of the DA is to protect new or original designs from getting copied, and ensure that the creator, originator or artisan of the design is not deprived of their rightful gains for the creation of their design. The central government also drafted the DR under the authority of the DA for the purposes of specifying certain prescriptions regarding the practical aspects related to designs such as payment of fees, register for designs, classification of goods, address for service, restoration of designs, etc.

Other applicable laws

The Electricity Act, 2003 (“Electricity Act”)

The Electricity Act consolidates the laws relating to generation, transmission, distribution, trading and use of electricity. It lays down provisions in relation to transmission and distribution of electricity. It states that the State Government can specify suitable measures for specifying action to be taken in relation to any electric line or electrical plant, or any electrical appliance under the control of a consumer for the purpose of eliminating or reducing the risk of personal injury or damage to property or interference with its use.

Other Indian laws

In addition to the above, we are also governed by the provisions of the Companies Act and rules framed thereunder, fire-safety related laws, contract act, foreign trade laws and other applicable laws and regulation imposed by the Central Government and State Governments and other authorities for our day to day business, operations and administration.

HISTORY AND CERTAIN CORPORATE MATTERS

Brief history of our Company

Our Company was originally incorporated as 'Ram Ratna Agro-Plast Limited' at Mumbai, Maharashtra as a public company under the Companies Act, 1956, pursuant to the certificate of incorporation dated February 6, 1995, issued by RoC and commenced operations pursuant to a certificate of commencement of business dated June 29, 1995. Subsequently, the name of our Company was changed to 'R R Kabel Limited' to align the name with the business activity of the Company and a fresh certificate of incorporation dated November 8, 2000 was issued by the RoC.

Changes in our Registered Office

The following table sets forth details of the change in the registered office of our Company since the date of its incorporation:

Date of change	Details of the change in address of registered office	Reason
April 14, 2001	The registered office of our Company was changed from 405/406, Kewal Industrial Estate, S. B. Marg, Lower Parel, Mumbai 400 013, Maharashtra to Ram Ratna House, Victoria Mill Compound, Pandurang Budhkar Marg, Worli, Mumbai 400 013, Maharashtra	Administrative convenience

Main objects of our Company

The main objects contained in our Memorandum of Association are as follows:

- "To manufacture, produce, fabricate, process, convert, refine, prepare, import, export, sell, distribute and carry on the business of agents and dealers in all types of pipes, tubes, hoses, vessels, containers, wrapping materials, accessories, fittings, appliances, spare parts, articles and things made of polyvinyl chloride, polyethylene, polystyrene, polycarbonate, polytetrafluoroethylene, acrylics, nylon and other kinds of plastic P.V.C sheets, plain, corrugated, uniform or non-uniform geometrical shapes whether reinforced or otherwise, rubber and other synthetics, fibrous and non-fibrous materials and substances blends, metals, alloys, thereof, required for use in overhead, surface and underground irrigation, industrial, agricultural and earth moving machinery, mopeds, scooters, cars, trucks, tractors, dumpers and other vehicle, to manufacture complete range of plastic reel and bobbins, electrical insulated conductors, bare conductor, welding wire and cables, synthetic/cotton yarns or any other metallic or non-metallic wires/threads.*
- To manufacture, buy, sell, exchange, alter, improve, manipulate, prepare for market, import, export, trading or otherwise deal in all kinds of insulated cables and wires, rubber insulated wires and cables, cab tyre sheathed wires, cables and flexibles; flexible cords, cotton or silk braided conduit wires and cables, low and high tension paper, rubber or bitumen insulated lead covered power cables armoured or non-armoured extra high tension, shielded and belted power cables type H.H.S.L. etc., Mining shaft, Submarine, and Marine Power cables, telephone and telegraph cables, signalling cables, lead covered cables, for house installation, accessories for power cables, alplastable cables with seamless aluminium sheath covered with a second seamless skin of thermo-plastic material, overhead material, bare copper, bronze, aluminium wires and cables solid or strand for telephone telegraph and signalling purposes, PVC compound and other compounds like XLPE, HFFR, Master batch, Polyethylene, P.V.C. Nylons, HDPE LDPE, P.P. Polystyrene, Solvents and lamination materials, Pipes, tubes and fittings.*
- To carry on the business of manufacturing assembling, altering, exchanging, buying, selling, importing, exporting, trading or otherwise dealing in all types of electrical goods and instruments including circuit breakers, HRC fuses, meters, rectifiers, contactors, converters and alternators, current transformers, switches, switchgears, miniature circuit breakers, earth leakage circuit breakers, panels, electric motors, generators, electric magnets, motor control centres, power control centres, distribution boards, rising mains, bus trunking, copper bus duct, overhead busbar systems, switches and condensers, related accessories.*
- To carry on the business as manufacturers, importers and exporters merchants and traders of electric and electronic mixtures and grinders pressure cookers, electrical and electronic baking ovens, electrical and electronic burners, gas burners, electrical and electronic gas and oven lighters, cooking range, electrical and electronic and automatic irons, electrical and electronic toasters, electric and electronic heaters including room heaters and domestic water heaters, geysers for hot water, doorbells including remote control bells and alarms electrical and electronic and automatic door closers and parts and spares thereof.*

5. *To carry on the business as manufacturers, importers and exporters merchants and traders of sockets, lamps, bulbs, troches, bulbs, fluorescent tubes, lamps, extension lamps, automatic portable emergency lights, portable generators, fluorescent emergency lights, voltage, stabilizers, extension codes of every type, wires, panels Range of luminaries choke patti, switches, commercial Industrial decorative lighting luminaries and accessories and parts and spares thereof.*
6. *To carry on the business as manufacturers, importers and exporters merchants and traders of Radio sets multi-channel, black and white and colored multichannel television sets, tape recorders, cassette recorders of every combination with or without remote controller and with or without foreign collaboration with permission of Government.*
7. *To carry on the business of manufacturers, exporters, importers, traders, dealers and distributors of all types of electrical and consumer appliances like air coolers, electrical fans, air conditioners, refrigerators, electrical fitting, switch gear boxes, music system including music players, computer operated music system, etc.”*

The main objects as contained in our Memorandum of Association enable our Company to carry on the business presently being carried on and proposed to be carried on by our Company.

Amendments to our Memorandum of Association

The following table set forth details of the amendments to our Memorandum of Association, in the last 10 years preceding the date of this Red Herring Prospectus:

Date of Shareholders' resolution/Effective date	Details of the amendments
October 11, 2014	Clause V of the Memorandum of Association of our Company was amended to reflect the increase in authorised equity share capital from ₹250,000,000 divided into 25,000,000 equity shares of face value of ₹10 each to ₹270,000,000 divided into 27,000,000 equity shares of face value of ₹10 each
August 9, 2018	<p>Clause III(A) of the Memorandum of Associations of our Company was amended to insert sub-clause 2 and 3 in the main object clause as:</p> <p>2. <i>“To manufacture, buy, sell, exchange, alter, improve, manipulate, prepare for market, import, export, trading or otherwise deal in all kinds of insulated cables and wires, rubber insulated wires and cables, cab tyre sheathed wires, cables and flexibles; flexible cords, cotton or silk braided conduit wires and cables, low and high tension paper, rubber or bitumen insulated lead covered power cables armoured or non-armoured extra high tension, shielded and belted power cables type H.H.S.L. etc., Mining shaft, Submarine, and Marine Power cables, telephone and telegraph cables, signalling cables, lead covered cables, for house installation, accessories for power cables, alplastable cables with seamless aluminium sheath covered with a second seamless skin of thermo-plastic material, overhead material, bare copper, bronze, aluminium wires and cables solid or strand for telephone telegraph and signalling purposes, PVC compound and other compounds like XLPE, HFFR, Master batch, Polyethylene, P.V.C. Nylons, HDPE LDPE, P.P. Polystyrene, Solvents and lamination materials, Pipes, tubes and fittings.</i></p> <p>3. <i>To carry on the business of manufacturing assembling, altering, exchanging, buying, selling, importing, exporting, trading or otherwise dealing in all types of electrical goods and instruments including circuit breakers, HRC fuses, meters, rectifiers, contactors, converters and alternators, current transformers, switches, switchgears, miniature circuit breakers, earth leakage circuit breakers, panels, electric motors, generators, electric magnets, motor control centres, power control centres, distribution boards, rising mains, bus trunking, copper bus duct, overhead busbar systems, switches and condensers, related accessories.”</i></p>
August 9, 2018	Clause V of the Memorandum of Association of our Company was amended to reflect the increase in authorised equity share capital from ₹270,000,000 divided into 27,000,000 equity shares of face value of ₹10 each to ₹4,269,999,609 divided into 27,000,000 equity shares of face value of ₹10 each and 3,702,572 Preference Shares of face value ₹1,080.33 each
September 25, 2020	Clause V of the Memorandum of Association of our Company was amended to reflect the increase in authorised equity share capital from ₹4,269,999,609 divided into 27,000,000 equity shares of face value of ₹10 each and 3,702,572 Preference Shares of face value ₹1,080.33 each to ₹4,719,999,108 divided into 57,000,000 equity shares of face value of ₹10 each and 3,841,418 Preference Shares of face value ₹1,080.33 each

Date of Shareholders' resolution/Effective date	Details of the amendments
	<p>Clause III(A) of the Memorandum of Association of our Company was amended to insert the following objects:</p> <ol style="list-style-type: none"> 4. <i>“To carry on the business as manufacturers, importers and exporters merchants and traders of electric and electronic mixtures and grinders pressure cookers, electrical and electronic baking ovens, electrical and electronic burners, gas burners, electrical and electronic gas and oven lighters, cooking range, electrical and electronic and automatic irons, electrical and electronic toasters, electric and electronic heaters including room heaters and domestic water heaters, geysers for hot water, doorbells including remote control bells and alarms electrical and electronic and automatic door closers and parts and spares thereof.</i> 5. <i>To carry on the business as manufacturers, importers and exporters merchants and traders of sockets, lamps, bulbs, troches, bulbs, fluorescent tubes, lamps, extension lamps, automatic portable emergency lights, portable generators, fluorescent emergency lights, voltage, stabilizers, extension codes of every type, wires, panels Range of luminaries choke patti, switches, commercial Industrial decorative lighting luminaries and accessories and parts and spares thereof.</i> 6. <i>To carry on the business as manufacturers, importers and exporters merchants and traders of Radio sets multi-channel, black and while and colored multichannel television sets, tape recorders, cassette recorders of every combination with or without remote controller and with or without foreign collaboration with permission of Government.</i> 7. <i>To carry on the business of manufacturers, exporters, importers, traders, dealers and distributors of all types of electrical and consumer appliances like air coolers, electrical fans, air conditioners, refrigerators, electrical fitting, switch gear boxes, music system including music players, computer operated music system, etc”</i>
December 18, 2020	<p>Clause V of the Memorandum of Association of our Company was amended to reflect the increase in authorised equity share capital from ₹4,719,999,108 divided into 57,000,000 equity shares of face value of ₹10 each and 3,841,418 Preference Shares of face value ₹1,080.33 each to ₹4,721,859,437 divided into 57,000,000 equity shares of face value of ₹10 each and 3,843,140 Preference Shares of face value ₹1,080.33 each</p>
March 20, 2023	<p>Clause V of the Memorandum of Association of our Company was amended to reflect the sub-division of face value of equity shares from ₹10 to ₹5. The authorized share capital of our Company was amended from ₹4,721,859,437 divided into 57,000,000 equity shares of face value of ₹10 each and 3,843,140 Preference Shares of face value ₹1,080.33 each to ₹4,721,859,437 divided into 114,000,000 Equity Shares of ₹5 each and 3,843,140 Preference Shares of face value ₹1,080.33 each</p> <p>Clause V of the Memorandum of Association of our Company was amended to reflect the increase in authorised equity share capital from ₹4,721,859,437 divided into 114,000,000 Equity Shares of ₹5 each and 3,843,140 Preference Shares of face value ₹1,080.33 each to ₹4,751,859,437 divided into 120,000,000 Equity Shares of ₹5 each and 3,843,140 Preference Shares of face value ₹1,080.33 each</p>

Major events and milestones in the history of our Company

The table below sets forth the key events and milestones in the history of our Company:

Financial Year	Particulars
1999	Establishment of the first manufacturing facility in Silvassa and commenced the operations
2004	Commencement of in-house manufacturing of PVC compound
2011	Establishment of manufacturing plant in the industrial belt of Vadodara
2019	Acquisition of 21.01% shareholding by TPG Asia VII SF Pte. Ltd. in our Company
2019	Commencement of exports to USA
2020	Amalgamation of Ram Ratna Electricals Limited with our Company
2019	Acquisition of LED business of Arraystorm Lighting Private Limited
2021	Commencement of manufacturing of switch
2022	Acquisition of home electrical business ‘Luminous Fans and Light’

Awards, accreditations and recognitions received by our Company

Calendar Year	Award
2017	Won the “POWER BRAND INDIA 2017” award in “Industry Trendsetter” category at the Power Brands Glam Summit held in London, UK on May 12, 2017
2018	Won the “Marketing Campaign of the year 2018” organized by ABP News Barnd Excellence Award
2022	Awarded the "Best Brand in Building Material & Fittings" category at the ET Infra Focus Summit & Awards

Time and cost over-runs

Other than in the ordinary course of business, there have been no time and cost over-runs in respect of our business operations.

Defaults or re-scheduling, restructuring of borrowings with financial institutions or banks

There have been no defaults or rescheduling/restructuring of borrowings with financial institutions/ banks in respect of our Company’s borrowings.

Significant financial and/or strategic partners

Our Company does not have any significant financial and/or strategic partners as on the date of this Red Herring Prospectus.

Launch of key products or services, entry into new geographies or exit from existing markets, capacity/ facility creation or location of plants

For details of key products or services launched by our Company, entry into new geographies or exit from existing markets, capacity/ facility creation, location of our manufacturing facilities, see “Our Business” beginning on page 190.

Details regarding material acquisitions or divestments of business/undertakings, mergers, amalgamation, any revaluation of assets, etc. in the last 10 years

Except as stated below, our Company has not acquired any business or undertaking and has not undertaken any merger, amalgamation or revaluation of assets in the last 10 years.

Business Transfer Agreement (“BTA”) dated April 12, 2022, entered into between Luminous Power Technologies Private Limited (“LPTPL”) and our Company

Our Company entered into a BTA pursuant to which LPTPL transferred and our Company purchased the home electrical business consisting of manufacturing, assembly and distribution of the fans and lighting business (excluding the wiring devices, inverter, battery, voltage stabilizers and solar business) together with the assets, assumed liabilities and certain employees, by way of slump sale basis (“**Business Undertaking**”). The total consideration that was paid pursuant to the BTA was ₹ 1,045.80 million.

Further, with the objective of facilitating unhindered operations of the Business Undertaking, our Company entered into a brand licensing agreement (“**BLA**”) dated May 1, 2022 with LPTPL for the grant of an exclusive, non-transferable and non-assignable limited license for the licensed brands as mentioned in the BLA, where such license and permission does not include usage of the standalone brand ‘Luminous’. Pursuant to the BLA, our Company is prohibited from any co-branding including usage of any other name, mark, slogans, tag lines, descriptors, wordings, devices, styles of labelling, emblems or other manifestations or characteristic which is ‘confusingly similar’ to the licensed brands. Our Company is licensed to use the brands for an initial period of two years subject to extension of six months at a time for a maximum of four times.

Scheme of Amalgamation 2020

Pursuant to a resolution dated September 24, 2019 passed by our Board, our Company filed a scheme of amalgamation with RREL under Sections 230 to 232 of the Companies Act, 2013 before the National Company Law Tribunal, Mumbai. The rationale of the scheme was *inter alia* to consolidate the business operations since both the companies were engaged in similar line of business of electrical cables and electrical products, achieving greater efficiencies in operations and reduction of overheads and other expenses. Pursuant to this scheme, all the assets (including intangible assets), estate, properties, investment of all kinds (such as shares, scrips, stocks, bonds, debenture stock, units or pass through certificates and commodities), statutory licenses, permissions, approvals, legal proceedings, debts and employees of RREL were transferred to our Company as a going concern. Further, pursuant to the scheme, the shareholders of RREL were allotted two fully paid-up Equity Shares of our Company for every five fully paid-up equity share of face value of ₹100 of RREL and two fully paid up Preference Shares of our Company for every five fully paid preference share of face value ₹426.84 of RREL, as consideration. The authorised share

capital of RREL amounting to ₹450,000,113 was merged with our Company and the main objects clause of RREL was inserted in the main objects clause of the Memorandum of Association of our Company in order to enable the Company to carry on the actual commercial activities of RREL. The National Company Law Tribunal, Mumbai approved the scheme pursuant to an order dated August 19, 2020 and the scheme came into effect from September 25, 2022.

Scheme of Amalgamation 2014

Pursuant to a resolution dated September 23, 2014 passed by our Board, our Company filed a scheme of amalgamation with GEFL and RRPL (together with GEFL, “Transferor Companies”) under Sections 391 to 394 of the Companies Act, 1956 before the High Court of Bombay. The rationale of the scheme was inter alia to enable economic and efficient management control and business operations since our Company and the Transferor Companies were part of the same promoter group. Pursuant to this scheme, the assets, immovable properties (including land together with the buildings and structures standing thereon) and rights and interest in immovable properties, all contracts, deeds, bonds, agreements, arrangements, statutory licenses, permissions, approvals, debts, legal proceedings and employees of the Transferor Companies were transferred to our Company. Further, pursuant to the Scheme, shareholders of GEFL, were allotted two equity shares of face value ₹10 of our Company for every one equity share of the GEFL as fully paid up shares, while shareholders of RRPL, were allotted five equity shares of face value of ₹10 of our Company for every two equity share of GEFL as fully paid-up shares. The authorised share capital of our Company was increased from ₹250,000,000 divided into 25,000,000 equity shares of face value of ₹10 each to ₹270,000,000 divided into 27,000,000 equity shares of face value of ₹10 each. The High Court of Bombay approved the scheme pursuant to an order dated September 12, 2014 and the scheme came into effect from October 11, 2014.

Our holding company

As on the date of this Red Herring Prospectus, our Company does not have a holding company.

Our subsidiaries and joint ventures

As on the date of this Red Herring Prospectus, our Company does not have any subsidiaries. Further, as on the date of this Red Herring Prospectus, our Company has one joint venture. The details of our Joint Venture have been provided below.

1. RR-Imperial Electricals Limited (“R R Imperial”) Corporate Information

R R Imperial was incorporated as a private limited company under the Companies Act of 1994 of Bangladesh on January 9, 2011. Its registered office is situated at Plot No-50, Block-C, Fisons Road, Charagali, Tongi, Gazipur, Bangladesh.

Nature of Business

R R Imperial is engaged in the business of manufacturers and processors of and buy or otherwise acquire, sale, import, export, distribute or otherwise deal in and to produce super enamelled copper, aluminium winding wires, strips, bus bars, electrical motors, fans, switches, circuit breakers, transformers, electrical panel boards, CFL bulbs, D.C.C., S.C.C., D.P.C., P.V.C., fibre glass, asbestos, plastic insulated, drycore core paper insulated covered and all kinds of wires, litz wires, cables, felexes, telecables, non-ferrous conductors, including A.C.S.R. conductors and all electrical goods.

Capital Structure

The authorised share capital of R R Imperial is BDT 1,000,000,000 divided into 100,000,000 shares of BDT 10 each and an issued, subscribed and paid up share capital of BDT 634,024,400 divided into 63,402,440 shares of BDT 10 each.

Shareholding

Our Company holds 210,000 shares in R R Imperial which represents 35% of the share capital of RREL.

The shareholding pattern as on the date of this Red Herring Prospectus is set out below:

Name of the shareholder	No. of ordinary shares of par value of BDT 10 each	% of total ordinary share holding
Our Company	22,190,854	35.00
MEW Electricals Limited	3,170,122	5.00
Ram Ratna Wires Limited	6,340,244	10.00

Name of the shareholder	No. of ordinary shares of par value of BDT 10 each	% of total ordinary share holding
Raghib Hassan	3,487,134	5.50
Imperial Allied Chemicals Limited	13,948,538	22.00
Mahboob Hossain Mirdah	1,902,073	3.00
A.N.M Mazoor Murshed	5,389,207	8.50
Ahmed Ashfaqur Rahman	1,902,073	3.00
Amin Mohammad Ahsanul Bari	5,072,195	8.00
Total	63,402,440	100.00

Accumulated profits or losses

As on the date of this Red Herring Prospectus, there are no accumulated profits or losses of R R Imperial that have not been accounted for by our Company.

Details of shareholders' agreements

Except as disclosed below, our Company does not have any subsisting shareholders' agreements among our Shareholders vis-a-vis our Company:

Summary of key agreements

A. Key terms of the shareholders' agreements

Shareholders' agreement dated July 7, 2018 ("SHA") entered into by and among our Company, our Promoters and certain other parties (together with our Promoters, "Company Selling Shareholders"), and TPG Asia VII SF Pte. Ltd. (together with Company, Company Selling Shareholders, "SHA Parties"), as amended and supplemented pursuant to deed of adherence dated December 3, 2019 executed with Arjun Kabra, deed of adherence dated October 11, 2021 executed with Ivaan Kabra and deed of adherence dated January 24, 2022 executed with Monal Rajesh Kabra (SHA Parties together with Arjun Kabra, Ivaan Kabra and Monal Rajesh Kabra, "Parties"), Securities Subscription and Share Purchase Agreement dated July 7, 2018 entered into by and among the SHA Parties ("SSPA") and Waiver Cum Amendment Agreement dated May 3, 2023 by and among the Parties ("SHA Amendment Agreement") and the SHA Second Amendment Agreement dated August 30, 2023, by and among the Parties ("SHA Second Amendment Agreement").

In terms of the SSPA and SHA, TPG Asia VII SF Pte. Ltd. purchased 1,990,128 equity shares of face value of ₹10 of the Company from the Company Selling Shareholders and subscribed to 3,702,572 Preference Shares. Pursuant to such subscription and purchase of shares of our Company, TPG Asia VII SF Pte. Ltd. acquired 20.44% of the Equity Share Capital of our Company on a fully diluted basis. Consequently, the SHA was entered into by and among the Parties. In terms of the SHA, TPG Asia VII SF Pte. Ltd. has a right to nominate up to two directors and have also been provided with certain key rights including the right to appoint observers, certain tag-along rights, right of first offer, drag along rights, anti-dilution adjustments, information rights and other such rights in accordance with the terms of the SHA. Further, pursuant to the SHA, our Company undertook a buyback of 750,724 equity shares of face value of ₹10 of the Company upon which the shareholding of TPG Asia VII SF Pte. Ltd. was increased to 21.01% on a fully diluted basis.

Our Company entered into the Shareholders Amendment Agreement with the Parties, which provides for the waiver and amendment of certain terms of the SHA, as well as termination of the SHA upon receipt of final listing and trading approvals from the Stock Exchanges for the listing and trading of the Equity Shares pursuant to the IPO. Pursuant to the SHA Amendment Agreement, the Parties have agreed to waive certain special rights including right to appoint observers, restrictions on the transfer of Equity Shares pursuant to the Offer for Sale and anti-dilution protection. Parties have also consented to certain matters relating to the Offer and from the date of filing of the Red Herring Prospectus with the RoC, TPG Asia VII SF Pte. Ltd will not have any information rights, inspection rights and rights in relation to meetings with senior management.

Further, the Parties have agreed that for so long as the Promoters remain promoters of our Company under applicable law, the Promoters (acting jointly) shall be entitled to nominate up to three directors to the Board. In addition, TPG Asia VII SF Pte. Ltd. shall be entitled to nominate one investor director to the Board, provided that its shareholding in our Company (together with its affiliates) on a fully diluted basis does not fall below 5% of the Equity Share Capital of our Company solely as a result of a transfer of Equity Shares to a third party purchaser. However, upon receipt of final approvals for the listing and trading of the Equity Shares of our Company on the Stock Exchanges, only TPG Asia VII SF Pte. Ltd. shall be entitled to nominate one director to the Board, provided that its shareholding in our

Company (together with its affiliates) on a fully diluted basis does not fall below 5% of the Equity Share capital of our Company. This nomination right available to TPG Asia VII SF Pte. Ltd. shall come into effect only upon approval of the Shareholders through a special resolution at the first general meeting of the Company held post listing of the Equity Shares on the Stock Exchanges and the consequent incorporation of such provision in the Articles of Association of our Company, in accordance with applicable law.

The Parties have agreed that upon the receipt of final approvals for the listing and trading of the Equity Shares on the Stock Exchanges, the SHA, as amended or modified pursuant to the SHA Amendment Agreement and the SHA Second Amendment Agreement shall terminate in its entirety without any further act or deed required, except the abovementioned provision related to director nomination by TPG Asia VII SF Pte. Ltd. that shall survive the termination of the SHA. The Parties have also agreed that in the event (i) the Offer is not completed on or prior to the earlier of (a) the expiry of 12 months from the date of filing of this Red Herring Prospectus with SEBI and the Stock Exchanges, or (b) the date on which the Board decides to withdraw the Offer, which may be further extended by mutual agreement of the Parties (“**Long Stop Date**”); or (ii) our Company and the Selling Shareholders, in consultation with the Book Running Lead Managers, decide not to undertake the Offer, the SHA Amendment Agreement shall stand immediately terminated with effect from the Long Stop Date or on the date on which our Company and the Selling Shareholders, in consultation with the Book Running Lead Managers, decide not to undertake the Offer, whichever is earlier, without any further action by any Party, and the SHA shall immediately and automatically stand re-instated with full force and effect.

B. Key terms of the other material agreements

1. Trademark license agreement dated April 29, 2015 between our Company and Ram Ratna Research and Holdings Private Limited, (“License Agreement”) as amended by the amendment to the trademark license agreement dated August 10, 2018 (“Amended License Agreement”)

Our Company and Ram Ratna Research and Holdings Private Limited (“**RRHPL**”) entered into the License Agreement, pursuant to which our Company was granted a non-exclusive license to use certain trademarks, namely ‘RR’, ‘RR✓’ and  (“**Trademarks**”) in connection with the business of our Company. Our Company is permitted to use the Trademarks at all material times for the purposes and objects of our business. This license granted by RRHPL is effective for a term of 14 years from the date of execution of the Amended License Agreement. Our Company is required to pay a royalty fee of ₹7,500 per annum to RRHPL payable before March 31 of each financial year.

Details of guarantees given to third parties by our Promoters who are participating in the Offer for Sale

Except as disclosed below, no guarantees have been issued by Mahendrakumar Rameshwarlal Kabra, the Promoter Selling Shareholder, on behalf of our Company to any third parties, which are outstanding as on the date of this Red Herring Prospectus. These guarantees are in the nature of personal guarantees and have been issued towards contractual obligations in respect of loans availed by our Company:

S. No.	Date of sanction letter/ deed of guarantee	Lender	Type of facility	Sanctioned amount of facility (in ₹ million)	Consideration	Reason
1.	March 25, 2021	State Bank of India	Cash credit, pre-shipment and post-shipment, overdraft, letter of credit facility	1,215.00	Nil	Personal guarantee in respect of the cash credit, pre-shipment and post-shipment, overdraft, letter of credit facility availed by our Company
		Standard Chartered Bank		900.00		
		DBS Bank India Limited		250.00		
		Yes Bank Limited		250.00		
		HSBC Limited		600.00		
		Kotak Mahindra Bank Limited		435.00		
		Citibank NA.		300.00		
		HDFC Bank Limited		700.00		
2.	July 3, 2019	Federal Bank	Working capital facility and	450.00	Nil	Personal guarantee in respect of working capital loan facility availed by our Company

S. No.	Date of sanction letter/ deed of guarantee	Lender	Type of facility	Sanctioned amount of facility (in ₹ million)	Consideration	Reason
			forward cover limit			
3.	November 26, 2019	DBS Bank India Limited	Working capital facility	500.00	Nil	Personal guarantee in respect of Working capital loan facility availed by our Company
4.	January 7, 2020	HDFC Bank Limited	Short term loan	270.00	Nil	Personal guarantee in respect of short term loan facility availed by our Company
5.	December 2, 2019	HDFC Bank Limited*	Rupee term loan	1,000.00	Nil	Personal guarantee in respect of rupee term loan facility availed by our Company for capital expenditure
6.	September 30, 2017	Citicorp Finance (India) Limited#	Rupee term loan	600.0	Nil	Personal guarantee in respect of rupee term loan facility availed by our Company for capital expenditure
7.	May 11, 2021	Axis Bank Limited	Working capital facility and letter of credit	300.00	Nil	Personal guarantee in respect of working capital loan and letter of credit facility availed by our Company
8.	December 18, 2017	Kotak Mahindra Bank Limited	Working capital facility	65.00	Nil	Personal guarantee in respect of working capital loan facility availed by our Company
9.	March 12, 2020	HSBC Limited	Working capital facility	400.00	Nil	Personal guarantee in respect of working capital loan facility availed by our Company
10.	August 11, 2021	Yes bank	Letter of credit	650.00	Nil	Personal guarantee in respect of letter of credit facility availed by our Company

*Personal guarantee is executable on the outstanding amount of ₹437.47 million as on June 30, 2023.

Personal guarantee is executable on the outstanding amount of ₹74.45 million as on June 30, 2023.

The aforementioned guarantees are effective for a period till the underlying facilities are repaid. In the event of any default by the principal borrower towards payment of the outstanding amount under the aforementioned facilities, Mahendrakumar Rameshwarlal Kabra, the Promoter Selling Shareholder shall be liable for the payment of the outstanding amount, including the interest amount, expenses incurred by the lender and any loss suffered by reason of such default. For further details in relation to outstanding amount as of March 31, 2023, see “*Restated Consolidated Financial Information – Annexure VI- Notes to Restated Consolidated Financial Information- Notes 13A and 13B: Borrowings*” on page 312.

Agreements with Key Managerial Personnel or Senior Management Personnel, Director, Promoters, or any other employee

Our Key Managerial Personnel or Senior Management Personnel, Director, Promoters, or any other employee have not entered into any agreement with the any shareholder or any third party with regard to compensation or profit sharing in connection with dealings in the securities of our Company.

Other confirmations

Other than as disclosed above, there are no other agreements, including any deed of assignment, acquisition agreement, shareholders’ agreement, inter-se agreements, agreements of like nature, to which we are a party, which are material and which are required to be disclosed. Further, we confirm that there are no other clauses or covenants which are material, adverse or pre-judicial to the interest of the minority/ public shareholders.

OUR MANAGEMENT

In terms of the Articles of Association, our Company can have a maximum of 15 Directors. As on the date of this Red Herring Prospectus, our Board comprises of three Executive Directors, one Non-Executive Nominee Director and four Independent Directors. One of our Independent Directors is a woman Director.

Details regarding our Board as on the date of this Red Herring Prospectus are set forth below:

S. No.	Name, DIN, designation, date of birth, current term, period of directorship, address, occupation and age	Other Directorships
1.	<p>Tribhuvanprasad Rameshwarlal Kabra</p> <p>Designation: Executive Chairman</p> <p>Current Term: 5 years with effect from September 24, 2022 till September 23, 2027, liable to retire by rotation</p> <p>Period of Directorship: Director since May 13, 1997</p> <p>Address: Uma Sadan, 178, Vinayak Society, Akota, Vadodara 390 020, Gujarat, India</p> <p>Occupation: Business</p> <p>Date of Birth: June 11, 1955</p> <p>DIN: 00091375</p> <p>Age: 68 years</p>	<p>Indian Companies:</p> <ul style="list-style-type: none"> • Kabel Buildcon Solutions Private Limited; • Ram Ratna Research and Holdings Private Limited; and • Ram Ratna Wires Limited <p>Foreign Companies:</p> <ul style="list-style-type: none"> • RR-Imperial Electricals Limited; and • TMG Global FZCO
2.	<p>Shreegopal Rameshwarlal Kabra</p> <p>Designation: Managing Director</p> <p>Current Term: 5 years with effect from June 28, 2019 till June 27, 2024, liable to retire by rotation</p> <p>Period of Directorship: Director since June 27, 2014</p> <p>Address: 9th & 10th Floor, Ishan Building, Plot No. 547, Jame Jamshed Road, Matunga CR, Mumbai 400 019, Maharashtra, India</p> <p>Occupation: Business</p> <p>Date of Birth: June 21, 1958</p> <p>DIN: 00140598</p> <p>Age: 65 years</p>	<p>Indian Companies:</p> <ul style="list-style-type: none"> • Jag-Bid Finvest Private Limited; • R R Busduct Private Limited; • R R Parkon Private Limited; • Ram Ratna Infrastructure Private Limited; and • Ram Ratna Research and Holdings Private Limited <p>Foreign Companies:</p> <ul style="list-style-type: none"> • TMG Global FZCO
3.	<p>Mahendrakumar Rameshwarlal Kabra</p> <p>Designation: Joint Managing Director</p> <p>Current Term: 5 years with effect from September 23, 2019 till September 22, 2024, liable to retire by rotation</p> <p>Period of Directorship: Director since February 6, 1995</p> <p>Address: Flat No. 1908, Tower 2, Casa Grande, 20th Floor, Senapati Bapat Marg, Lower Parel, Delisle Road, Mumbai 400 013, Maharashtra, India</p> <p>Occupation: Business</p>	<p>Indian Companies:</p> <ul style="list-style-type: none"> • Epavo Electricals Private Limited; • Global Copper Private Limited; • NAV Wireless Technologies Private Limited; • Ram Ratna Research and Holdings Private Limited; • Ram Ratna Wires Limited; and • Winding Wires Manufacturers Association of India

S. No.	Name, DIN, designation, date of birth, current term, period of directorship, address, occupation and age	Other Directorships
	<p>Date of Birth: May 13, 1957</p> <p>DIN: 00473310</p> <p>Age: 66 years</p>	<p>Foreign Companies:</p> <p>Nil</p>
4.	<p>Mitesh Daga</p> <p>Designation: Non-Executive Nominee Director⁽¹⁾</p> <p>Current Term: Not liable to retire by rotation</p> <p>Period of Directorship: Director since September 6, 2018</p> <p>Address: F-2302, Oberoi Splendor, JVLR, Opp. Majas Bus Depot, Jogeshwari East, Mumbai 400 060, Maharashtra, India</p> <p>Occupation: Service</p> <p>Date of Birth: August 24, 1979</p> <p>DIN: 08189217</p> <p>Age: 44 years</p>	<p>Indian Companies:</p> <ul style="list-style-type: none"> • Sai Life Pharma Private Limited; and • Sai Life Sciences Limited <p>Foreign Companies:</p> <p>Nil</p>
5.	<p>Bhagwat Singh Babel</p> <p>Designation: Independent Director</p> <p>Current Term: 5 years with effect from August 24, 2022 till August 23, 2027, not liable to retire by rotation</p> <p>Period of Directorship: Director since August 24, 2017</p> <p>Address: 221, Ameya, behind Sagar Darshan Apartment, near Vidya Bhavan School, Devali, Udaipur 313 001, Rajasthan, India</p> <p>Occupation: Business</p> <p>Date of Birth: July 24, 1953</p> <p>DIN: 01476935</p> <p>Age: 70 years</p>	<p>Indian Companies:</p> <ul style="list-style-type: none"> • Secure Meters Limited <p>Foreign Companies:</p> <p>Nil</p>
6.	<p>Ramesh Chandak</p> <p>Designation: Independent Director</p> <p>Current Term: 5 years with effect from April 29, 2023 till April 28, 2028, not liable to retire by rotation</p> <p>Period of Directorship: Director since April 29, 2023</p> <p>Address: Tower No.- 5, Flat No. 2901, Crescent Bay, Jerbai Wadia Road, Parel, Mumbai 400 012, Maharashtra, India</p> <p>Occupation: Business</p> <p>Date of Birth: November 7, 1946</p> <p>DIN: 00026581</p> <p>Age: 76 years</p>	<p>Indian Companies:</p> <ul style="list-style-type: none"> • Anand Rathi Wealth Limited; • First Bridge Fund Managers Private Limited (formerly known as Indianivesh Fund Managers Private Limited); • KEC International Limited; • Prince Pipes and Fittings Limited; • Ram Ratna Wires Limited; • Summit Securities Limited; and • Tribhovandas Bhimji Zaveri Limited

S. No.	Name, DIN, designation, date of birth, current term, period of directorship, address, occupation and age	Other Directorships
		Foreign Companies: Nil
7.	Vipul Sabharwal Designation: Independent Director Current Term: 5 years with effect from August 23, 2022 till August 22, 2027, not liable to retire by rotation Period of Directorship: Director since August 23, 2022 Address: House no. 9218, DLF Phase - 4, Gurgaon 122 001, Haryana, India Occupation: Service Date of Birth: August 4, 1961 DIN: 03429263 Age: 62 years	Indian Companies: Nil Foreign Companies: Nil
8.	Jyoti Davar Designation: Independent Director Current Term: 5 years with effect from December 16, 2022 till December 15, 2027, not liable to retire by rotation Period of Directorship: Director since December 16, 2022 Address: A – 2A, Swarn Singh Road, Adarsh Nagar, Delhi 110 033, Delhi, India Occupation: Professional Date of Birth: July 29, 1967 DIN: 09757889 Age: 56 years	Indian Companies: <ul style="list-style-type: none"> • Walter Infra Manager Private Limited Foreign Companies: Nil

(1) Nominee of TPG Asia VII SF Pte. Ltd.

Brief Biographies of our Directors

Tribhuvanprasad Rameshwarlal Kabra is the Executive Chairman of our Company. He has completed his secondary level school education from Hindi High School, Mumbai. He has extensive experience in the electrical industry. Previously, he was associated with Shramik Winding Wires Private Limited as a director. He was appointed to our Board of Directors with effect from May 13, 1997.

Shreegopal Rameshwarlal Kabra is the Managing Director of our Company. He has completed his secondary level school education from Hindi High School, Mumbai. He has extensive experience in the electrical industry. Previously, he was associated with the International Copper Association as the chairman of wire and cable product council and the Indian Electrical and Electronics Manufacturers' Association as the president. He was appointed to our Board of Directors with effect from June 27, 2014.

Mahendrakumar Rameshwarlal Kabra is the Joint Managing Director of our Company. He has completed his secondary level school education from Hindi High School, Mumbai and holds a licentiate diploma in mechanical engineering from Veermata Jijabai Technological Institute Mumbai. He has extensive experience in the electrical industry. Previously, he was

associated with MEW Electricals Limited as a director. He was appointed to our Board of Directors with effect from February 6, 1995.

Mitesh Daga is a Non-Executive Nominee Director of our Company. He holds a degree of bachelor's of technology in chemical engineering from Indian Institute of Technology, Delhi and is also a holder of chartered financial analyst charter issued by the CFA Institute. He is the managing director at TPG Capital India Private Limited. Previously, he was associated with Advent India PE Advisors Private Limited, Zephyr Peacock Management India Private Limited and Capital One Services (India) Private Limited. He was appointed to our Board of Directors with effect from September 6, 2018.

Bhagwat Singh Babel is an Independent Director of our Company. He holds a degree of bachelor's in technology in electrical engineering from Banaras Hindu University and a diploma of membership from the Institution of Engineers (India). He is on the board of directors of Secure Meters and was also on the board of Udaipur Urja Initiatives Producer Company Limited and the Indian Electrical and Electronics Manufacturers' Association. He was appointed to our Board of Directors with effect from August 24, 2017.

Ramesh Chandak is an Independent Director of our Company. He holds a degree of master's in commerce from Nagpur University and has also completed a program on 'leading change and organizational renewal' from Harvard Business School. He is also a practicing member of the Institute of Chartered Accountants of India. Previously, he has served as the president of the Indian Electricals and Electronics Manufacturers' Association and is a trustee of the Victoria Memorial School for the Blind, Mumbai. He has been honoured with the 'CA Business Leader Corporate' award from the Institute of Chartered Accountants of India in 2008. He was appointed to our Board of Directors with effect from April 29, 2023.

Vipul Sabharwal is an Independent Director of our Company. He holds a degree of bachelor's in arts from University of Delhi and holds a master's of management studies degree from University of Bombay. Previously, he was associated with Luminous Power Technologies Private Limited as managing director, Whirlpool of India Limited as vice president of sales, service and brand, Nokia India Private Limited and Gillette India Limited as general sales director. He was appointed to our Board of Directors with effect from August 23, 2022.

Jyoti Davar is an Independent Director of our Company. She holds a degree of bachelor's in commerce from University of Delhi and holds a master's of arts degree from University of Delhi. Previously, she was associated with the Federation of Indian Chambers of Commerce & Industry as assistant secretary general and is currently designated as the deputy secretary general. She was appointed to our Board of Directors with effect from December 16, 2022.

Relationship between our Directors

Except for Tribhuvanprasad Rameshwarlal Kabra, Shreegopal Rameshwarlal Kabra and Mahendrakumar Rameshwarlal Kabra, who are brothers, none of our Directors are related to each other.

Confirmations

None of our Directors is or was a director of any listed company during the five years immediately preceding the date of this Red Herring Prospectus, whose shares have been or were suspended from being traded on any stock exchange during the term of their directorship in such company.

Further, none of our Directors is or was a director of any listed company which has been or was delisted from any stock exchange during the term of their directorship in such company.

Except Mitesh Daga, who has been nominated on the board by the Investor Selling Shareholder, there is no arrangement or understanding with the major Shareholders, customers, suppliers or others, pursuant to which any of our other Directors were appointed on the Board.

Further, our Directors have neither been identified as Wilful Defaulters nor been identified as Fraudulent Borrowers, as defined under the SEBI ICDR Regulations.

Terms of Appointment of our Executive Directors

Tribhuvanprasad Rameshwarlal Kabra

Pursuant to the resolution passed by the Shareholders on September 22, 2022, Tribhuvanprasad Rameshwarlal Kabra was re-appointed as the Executive Chairman of our Company and the tenure of his appointment was renewed to a period of five years beginning from September 24, 2022. Further, pursuant to the resolution passed by the Board on December 16, 2022, the terms of remuneration of Tribhuvanprasad Rameshwarlal Kabra was revised in accordance with the Sections 196 and 197 and 203

read with Schedule V of the Companies Act and Companies (Appointment and Remuneration of Managerial Personnel) Rules, 2014 as specified below.

Remuneration	
Particulars	Amount (in ₹ million per annum)
Remuneration:	25.20
Commission:	Up to 0.5% of the net profits of the Company in a particular year which shall be within the overall limits laid down in Section 198 of the Companies Act, 2013.

Shreegopal Rameshwarlal Kabra

Pursuant to the resolution passed by the Board on December 12, 2018, Shreegopal Rameshwarlal Kabra was re-appointed as the Managing Director of our Company and the tenure of his appointment was renewed to a period of 5 years beginning from June 28, 2019. Further, pursuant to the resolution passed by the Board on December 16, 2022, the terms of remuneration of Shreegopal Rameshwarlal Kabra was revised in accordance with the Sections 196 and 197 and 203 read with Schedule V of the Companies Act and Companies (Appointment and Remuneration of Managerial Personnel) Rules, 2014 as specified below.

Remuneration	
Particulars	Amount (in ₹ million per annum)
Remuneration:	25.20
Commission:	Up to 0.5% of the net profits of the Company in a particular year which shall be within the overall limits laid down in Section 198 of the Companies Act, 2013.

Mahendrakumar Rameshwarlal Kabra

Pursuant to the resolution passed by the Board on June 18, 2019, Mahendrakumar Rameshwarlal Kabra was re-appointed as the Joint Managing Director of our Company and the tenure of his appointment was renewed to a period of 5 years beginning from September 23, 2019. Further, pursuant to the resolution passed by the Board on June 18, 2019, Mahendrakumar Rameshwarlal Kabra will not be paid any remuneration by the Company.

Payment or benefit to Directors of our Company

Details of the sitting fees or other remuneration paid to our Directors in the Financial Year 2023 are set forth below.

i. Remuneration to our Executive Directors

Details of the remuneration paid to our Executive Directors in the Financial Year 2023 are set forth below:

S. No.	Name of Executive Director	Remuneration (in ₹ million)	Commission (in ₹ million)
1.	Tribhuvanprasad Rameshwarlal Kabra	17.10	13.62
2.	Shreegopal Rameshwarlal Kabra	17.10	13.62
3.	Mahendrakumar Rameshwarlal Kabra	0.28*	Nil

* Remuneration paid pursuant to sitting fees.

ii. Remuneration to our Non-Executive Nominee Director and Independent Directors

Pursuant to the resolution passed by our Board on September 6, 2018, each Independent Director is entitled to receive remuneration by way of sitting fees of ₹0.05 million for attending each meeting of the Board and ₹0.03 million for attending each meeting of the committees of the Board, within the limits prescribed under the Companies Act, and the rules made thereunder.

The details of remuneration paid to our Non-Executive Nominee Director and our Independent Directors during Financial Year 2023 are as follows:

S. No.	Name of Director	Sitting Fees (in ₹ million)	Commission (in ₹ million)	Total Remuneration (in ₹ million)
1.	Mitesh Daga	Nil	Nil	Nil
2.	Bhagwat Singh Babel	0.82	0.40	1.22
3.	Ramesh Chandak	N.A.	N.A.	N.A.

S. No.	Name of Director	Sitting Fees (in ₹ million)	Commission (in ₹ million)	Total Remuneration (in ₹ million)
4.	Vipul Sabharwal	0.34	Nil	0.34
5.	Jyoti Davar	0.15	Nil	0.15

As on the date of this Red Herring Prospectus, there is no contingent or deferred compensation payable to any of our Directors which accrued in Fiscal 2023.

Remuneration paid to our Directors by our Joint Venture

As on the date of this Red Herring Prospectus, none of our Directors are entitled to remuneration from our Joint Venture. None of our Directors received any remuneration from our Joint Venture in Fiscal 2023. Further, there is no contingent or deferred compensation payable to any of our Directors by our Joint Venture which accrued in Fiscal 2023.

Bonus or profit-sharing plan of the Directors

Except Tribhuvanprasad Rameshwarlal Kabra and Shreegopal Rameshwarlal Kabra who are entitled to receive up to 0.50% of the net profits of the Company as commission, our Company does not have any bonus or profit-sharing plan for our Directors. For details of the commission and performance bonus payable to them as a part of their respective remuneration, see “- *Terms of appointment of our Executive Directors*” on page 246.

Shareholding of Directors in our Company

As on the date of this Red Herring Prospectus, none of our Directors hold any Equity Shares, except as disclosed below:

Name of the Director	Number of Equity Shares held on a fully diluted basis*	Percentage of the pre-Offer Equity Share capital (%) on a fully diluted basis*
Tribhuvanprasad Rameshwarlal Kabra	6,896,889	6.21
Shreegopal Rameshwarlal Kabra	4,629,232	4.16
Mahendrakumar Rameshwarlal Kabra	8,648,588	7.78

* Assuming exercise of 91,864 vested options under ESOP 2020.

Our Articles of Association do not require our Directors to hold any qualification shares.

Interests of Directors

All our Directors may be deemed to be interested to the extent of remuneration and reimbursement of expenses, if any, payable to them by our Company as well as sitting fees, if any, payable to them for attending meetings of our Board or Committees thereof and any commission payable to them. For further details, see “- *Terms of Appointment of our Executive Directors*” and “- *Payment or benefit to Directors of our Company*”, on pages 246 and 247, respectively.

Our Directors may also be interested to the extent of Equity Shares and stock options, if any (together with dividends in respect of such Equity Shares), held by them in our Company or held by the entities in which they are associated as directors or partners, or that may be subscribed by or allotted to the companies, firms, ventures, trusts in which they are interested as promoters, directors, partners, proprietors, members or trustees, pursuant to the Offer and any dividend and other distributions payable in respect of such Equity Shares. For details, see “- *Shareholding of Directors in our Company*” on page 248.

Further, relatives of certain of our Directors are also shareholders and / or employees of our Company and may be deemed to be interested to the extent of the payment of remuneration made by our Company and dividends declared on the Equity Shares held by them, if any. For the payments that are made by our Company to such relatives of the Directors, see “*Restated Consolidated Financial Information – Annexure VI – Notes to Restated Consolidated Financial Information Note 33: Related party disclosures as required under Ind AS-24*” on page 330.

No consideration in cash or shares or otherwise has been paid or agreed to be paid to any of our Directors or to the firms or companies in which any of our Directors are interested, by any person, either to induce him to become, or to qualify him as, a Director, or otherwise for services rendered by our Directors or by the firm or company in which they are interested, in connection with the promotion or formation of our Company.

None of our Directors have any interest in any property acquired or proposed to be acquired of our Company or by the Company or in any transaction by our Company for acquisition of land, construction of building or supply of machinery. For details on

the relationship of our Executive Directors with entities from whom our Company has purchased land or agreed to purchase land, see “*Our Promoters and Promoter Group – Interests of Promoters and Common Pursuits*” on page 260.

Except Tribhuvanprasad Rameshwarlal Kabra, Mahendrakumar Rameshwarlal Kabra, and Shreegopal Rameshwarlal Kabra, who are the Promoters of our Company, none of our Directors have any interests in the promotion or formation of our Company. For details, see “*Our Promoters and Promoter Group- Interests of Promoters and Common Pursuits*” on page 260.

No loans have been availed or extended by our Directors from, or to, our Company.

Changes in our Board in the last three years

Details of the changes in our Board in the last three years are set forth below.

Name	Date of Change	Reason for change in board
Ramesh Chandak	April 29, 2023	Appointment as an independent director
Mukund Manohar Chitale	April 29, 2023	Resignation as an independent director
Jyoti Davar	December 16, 2022	Appointment as an independent director
Kirtidevi Shreegopal Kabra	December 16, 2022	Resignation as a whole-time director
Mahhesh Tribhuvanprasad Kabra	December 16, 2022	Resignation as a whole-time director
Sumeet Mahendrakumar Kabra	December 16, 2022	Resignation as a whole-time director
Sanjay Narnarayan Taparia	December 16, 2022	Resignation as a whole-time director
Rajesh Babu Jain	December 16, 2022	Resignation as a whole-time director
Kannan Ramamirtham	December 16, 2022	Resignation as an independent director
Puneet Bhatia	December 16, 2022	Resignation as a non-executive director
Tribhuvanprasad Rameshwarlal Kabra	September 24, 2022	Re-appointment as a whole-time director
Vipul Sabharwal	August 23, 2022	Appointment as an independent director
Bhagwat Singh Babel	August 23, 2022	Re-appointment as an independent director
Kirtidevi Shreegopal Kabra	January 1, 2022	Re-appointment as a whole-time director
Sumeet Mahendrakumar Kabra	January 1, 2022	Re-appointment as a whole-time director

Note: This does not include regularisations or change in designations.

Borrowing Powers of Board

Pursuant to its resolution dated January 6, 2014, our Board is empowered to borrow ₹7,500.00 million in accordance with Section 179 and Section 180 of the Companies Act and our Articles of Association. Pursuant to its resolution dated February 26, 2022, our Board has delegated its power to borrow money to the finance committee of our Company for an amount not exceeding ₹5,000.00 million.

Corporate Governance

The provisions of the SEBI Listing Regulations with respect to corporate governance will be applicable to us immediately upon listing of our Equity Shares with the Stock Exchanges. We are in compliance with the requirements of the SEBI Listing Regulations, the Companies Act, 2013 and other applicable regulations, in respect of corporate governance in respect of the constitution of the Board and Committees thereof, and formulation and adoption of policies.

Our Board has been constituted in compliance with the Companies Act, 2013 and the SEBI Listing Regulations.

As on the date of this Red Herring Prospectus, our Board comprises of eight Directors, including, three Executive Directors, one Non-Executive Nominee Director and four Independent Directors. In compliance with Section 152 of the Companies Act, 2013, not less than two thirds of the Directors (excluding Independent Directors) are liable to retire by rotation.

Our Company undertakes to take all necessary steps to continue to comply with all the requirements of SEBI Listing Regulations and the Companies Act, 2013.

Committees of the Board

Details of the Committees are set forth below. In addition to the Committees detailed below, our Board of Directors may, from time to time constitute Committees for various functions.

Audit Committee

The members of the Audit Committee are:

1. Ramesh Chandak (Independent Director), Chairman;
2. Bhagwat Singh Babel (Independent Director), Member;
3. Vipul Sabharwal (Independent Director), Member; and
4. Mitesh Daga (Non-Executive Nominee Director), Member;

The Audit Committee was last reconstituted pursuant to resolution passed by our Board on May 3, 2023. The scope and functions of the Audit Committee are in accordance with Section 177 of the Companies Act, 2013 and the SEBI Listing Regulations and its terms of reference as stipulated pursuant to resolution passed by our Board in its meeting held on May 3, 2023 are set forth below:

- (a) oversight of Company's financial reporting process and the disclosure of its financial information to ensure that the financial statement is correct, sufficient and credible;
- (b) recommendation for appointment, re-appointment and replacement, remuneration and terms of appointment of auditors, including the internal auditor, cost auditor and statutory auditor, of the Company and the fixation of audit fee;
- (c) approval of payment to statutory auditors for any other services rendered by the statutory auditors;
- (d) reviewing, with the management, the annual financial statements and auditor's report thereon before submission to the board for approval, with particular reference to:
 1. matters required to be included in the director's responsibility statement to be included in the board's report in terms of clause (c) of sub-section (3) of Section 134 of the Companies Act, 2013;
 2. changes, if any, in accounting policies and practices and reasons for the same;
 3. major accounting entries involving estimates based on the exercise of judgment by management;
 4. significant adjustments made in the financial statements arising out of audit findings;
 5. compliance with listing and other legal requirements relating to financial statements;
 6. disclosure of any related party transactions; and
 7. modified opinion(s) in the draft audit report.
- (e) reviewing, with the management, the quarterly, half-yearly and annual financial statements before submission to the board for approval;
- (f) reviewing, with the management, the statement of uses / application of funds raised through an issue (public issue, rights issue, preferential issue, etc.), the statement of funds utilized for purposes other than those stated in the offer document / prospectus / notice and the report submitted by the monitoring agency monitoring the utilisation of proceeds of a public or rights issue or preferential issue or qualified institutions placement, and making appropriate recommendations to the board to take up steps in this matter;
- (g) reviewing and monitoring the auditor's independence and performance, and effectiveness of audit process;
- (h) approval or any subsequent modification of transactions of the Company with related parties and omnibus approval for related party transactions proposed to be entered into by the Company subject to such conditions as may be prescribed;
- (i) scrutiny of inter-corporate loans and investments;
- (j) valuation of undertakings or assets of the Company, wherever it is necessary;
- (k) evaluation of internal financial controls and risk management systems;
- (l) reviewing, with the management, performance of statutory and internal auditors, adequacy of the internal control systems;

- (m) reviewing the adequacy of internal audit function, if any, including the structure of the internal audit department, staffing and seniority of the official heading the department, reporting structure coverage and frequency of internal audit;
- (n) discussion with internal auditors of any significant findings and follow up there on;
- (o) reviewing the findings of any internal investigations by the internal auditors into matters where there is suspected fraud or irregularity or a failure of internal control systems of a material nature and reporting the matter to the Board;
- (p) discussion with statutory auditors before the audit commences, about the nature and scope of audit as well as post-audit discussion to ascertain any area of concern;
- (q) to look into the reasons for substantial defaults in the payment to the depositors, debenture holders, shareholders (in case of non-payment of declared dividends) and creditors;
- (r) to review the functioning of the whistle blower mechanism;
- (s) approval of appointment of chief financial officer after assessing the qualifications, experience and background, etc. of the candidate;
- (t) carrying out any other function as is mentioned in the terms of reference of the audit committee;
- (u) reviewing the utilization of loans and/ or advances from/investment by the holding company in the subsidiary exceeding ₹100 crore or 10% of the asset size of the subsidiary, whichever is lower including existing loans / advances / investments existing; and
- (v) consider and comment on rationale, cost-benefits and impact of schemes involving merger, demerger, amalgamation etc., on the Company and its shareholders.
- (w) carrying out any other functions and roles as provided under the Companies Act, the SEBI Listing Regulations, each as amended and other applicable laws or by any regulatory authority and performing such other functions as may be necessary or appropriate for the performance of its duties; and
- (x) To carry out such other functions as may be specifically referred to the Committee by the Board of Directors and/or other Committees of Directors of the Company.

The Audit Committee shall mandatorily review the following information:

- management discussion and analysis of financial condition and results of operations;
- management letters / letters of internal control weaknesses issued by the statutory auditors;
- internal audit reports relating to internal control weaknesses; and
- the appointment, removal and terms of remuneration of the chief internal auditor shall be subject to review by the audit committee.
- statement of deviations:
 - (a) quarterly statement of deviation(s) including report of monitoring agency, if applicable, submitted to stock exchange(s) in terms of Regulation 32(1) of SEBI (Listing Obligations and Disclosure Requirements) Regulations, 2015, as amended.
 - (b) annual statement of funds utilized for purposes other than those stated in the offer document/prospectus/notice in terms of Regulation 32(7) of SEBI (Listing Obligations and Disclosure Requirements) Regulations, 2015, as amended.
- Such information as may be prescribed under the Companies Act and the SEBI (Listing Obligations and Disclosure Requirements) Regulations, 2015.

Nomination and Remuneration Committee

The members of the Nomination and Remuneration Committee are:

1. Ramesh Chandak (Independent Director), Chairman;
2. Bhagwat Singh Babel (Independent Director), Member;
3. Vipul Sabharwal (Independent Director), Member;
4. Mitesh Daga (Non-Executive Nominee Director), Member; and

The Nomination and Remuneration Committee was last reconstituted pursuant to resolution passed by our Board on April 29, 2023. The scope and functions of the Nomination and Remuneration Committee are in accordance with Section 178 of the Companies Act and the SEBI Listing Regulations and its terms of reference as stipulated pursuant to resolution passed by our Board in its meeting held on April 29, 2023 are set forth below:

1. Formulating the criteria for determining qualifications, positive attributes and independence of a director and recommend to the Board a policy relating to, the remuneration of the directors, key managerial personnel, senior management and other employees;

The Nomination and Remuneration Committee, while formulating the above policy, should ensure that:

- a) the level and composition of remuneration be reasonable and sufficient to attract, retain and motivate directors of the quality required to run the Company successfully;
 - b) relationship of remuneration to performance is clear and meets appropriate performance benchmarks; and
 - c) remuneration to directors, key managerial personnel and senior management involves a balance between fixed and incentive pay reflecting short and long term performance objectives appropriate to the working of the Company and its goals;
2. Formulating criteria for evaluation of performance of independent directors and the Board of Directors;
 3. For every appointment of an independent director, the Nomination and Remuneration Committee shall evaluate the balance of skills, knowledge and experience on the Board and on the basis of such evaluation, prepare a description of the role and capabilities required of an independent director. The person recommended to the Board for appointment as an independent director shall have the capabilities identified in such description. For the purpose of identifying suitable candidates, the Committee may:
 - i. use the services of an external agencies, if required;
 - ii. consider candidates from a wide range of backgrounds, having due regard to diversity; and
 - iii. consider the time commitments of the candidates.
 4. Devising a policy on diversity of Board;
 5. Identifying persons who are qualified to become directors and who may be appointed in senior management in accordance with the criteria laid down, and recommend to the Board of Directors their appointment and removal and shall specify the manner for effective evaluation of performance of the Board;
 6. Extending or continuing the term of appointment of the independent director, on the basis of the report of performance evaluation of independent directors;
 7. Recommending to the Board, all remuneration, in whatever form, payable to senior management;
 8. Carrying out any other function as may be required/ mandated by the Board from time to time and/ or mandated as per the provisions of the SEBI (Listing Obligations and Disclosure Requirements) Regulations, 2015, the Companies Act, 2013, the uniform listing agreements to be entered into between the Company and the respective stock exchanges on which the equity shares of the Company are proposed to be listed and/or any other applicable laws; and

Stakeholders' Relationship Committee

The members of the Stakeholders' Relationship Committee are:

1. Bhagwat Singh Babel (Independent Director), Chairman;
2. Ramesh Chandak (Independent Director), Member; and

3. Shreegopal Rameshwarlal Kabra (Managing Director), Member.

The Stakeholders' Relationship Committee was constituted pursuant to resolution passed by our Board in its meeting held on April 29, 2023. The scope and functions of the Stakeholder Relationship Committee are in accordance with Section 178 of the Companies Act, 2013 and the SEBI Listing Regulations and its terms of reference as stipulated pursuant to resolution passed by our Board in its meeting held on April 29, 2023 are set forth below:

1. To resolve the grievances of the security holders of the Company including complaints related to transfer/transmission of shares, non-receipt of annual report, non-receipt of declared dividends, issue of new/duplicate certificates, general meetings etc.;
2. To review measures taken for effective exercise of voting rights by shareholders;
3. To review adherence to the service standards adopted by the Company in respect of various services being rendered by the Registrar & Share Transfer Agent;
4. To review the various measures and initiatives taken by the Company for reducing the quantum of unclaimed dividends and ensuring timely receipt of dividend warrants/annual reports/statutory notices by the Shareholders of the Company; and
5. Carrying out such other functions and/or prescribed by the Board from time to time or specified/provided under the Companies Act, 2013 or the Securities and Exchange Board of India (Listing Obligations and Disclosure Requirements) Regulations, 2015, each as amended or any other applicable law as and when amended from time to time.

Risk Management Committee

The members of the risk management committee are:

1. Tribhuvanprasad Rameshwarlal Kabra (Executive Chairman), Chairman;
2. Bhagwat Singh Babel (Independent Director), Member; and
3. Dinesh Aggarwal (Chief Executive Officer), Member.

The Risk Management Committee was constituted pursuant to resolution passed by our Board in its meeting held on April 29, 2023. The scope and functions of the Risk Management Committee are in accordance with the SEBI Listing Regulations and its terms of reference as stipulated pursuant to resolution passed by our Board in its meeting held on April 29, 2023 are set forth below:

1. To formulate a detailed risk management policy which shall include:
 - a. A framework for identification of internal and external risks specifically faced by the listed entity, in particular including financial, operational, sectoral, sustainability (particularly, ESG related risks), information, cyber security risks or any other risk as may be determined by the Risk Management Committee;
 - b. Measures for risk mitigation including systems and processes for internal control of identified risks; and
 - c. Business continuity plan.
2. To ensure that appropriate methodology, processes and systems are in place to monitor and evaluate risks associated with the business of the Company;
3. To monitor and oversee implementation of the risk management policy, including evaluating the adequacy of risk management systems;
4. To periodically review the risk management policy, at least once in two years, including by considering the changing industry dynamics and evolving complexity;
5. To keep the board of directors informed about the nature and content of its discussions, recommendations and actions to be taken;

6. The appointment, removal and terms of remuneration of the chief risk officer (if any) shall be subject to review by the Risk Management Committee.
7. To carry out any other similar or other functions as may be laid down by the Board from time to time or specified/provided under the Companies Act, 2013 or the Securities and Exchange Board of India (Listing Obligations and Disclosure Requirements) Regulations, 2015.”

Corporate Social Responsibility Committee

The members of the corporate social responsibility committee are:

1. Bhagwat Singh Babel (Independent Director), Chairman;
2. Mahendrakumar Rameshwarlal Kabra, (Joint Managing Director), Member; and
3. Mitesh Daga (Non-Executive Nominee Director), Member.

The corporate social responsibility committee was last reconstituted pursuant to resolution passed by our Board on December 16, 2022. The scope and functions of the corporate social responsibility committee are in accordance with section 135 of the Companies Act, 2013 and its terms of reference as stipulated pursuant to resolution passed by our Board in its meeting held on April 29, 2023 are set forth below:

1. formulate and recommend to the Board, a “Corporate Social Responsibility Policy” which shall indicate the activities to be undertaken by the Company as specified in Schedule VII of the Companies Act, 2013, as amended;
2. recommend the amount of expenditure to be incurred on the activities referred to in clause (1);
3. To formulate and recommend to the Board, an annual action plan in pursuance to the Corporate Social Responsibility Policy, which shall include the following, namely:
 - a. the list of Corporate Social Responsibility projects or programmes that are approved to be undertaken in areas or subjects specified in the Schedule VII of the Companies Act, 2013;
 - b. the manner of execution of such projects or programmes as specified in Rule 4 of the Companies (Corporate Social Responsibility Policy) Rules, 2014;
 - c. the modalities of utilisation of funds and implementation schedules for the projects or programmes;
 - d. monitoring and reporting mechanisms for the projects or programmes; and
 - e. details of need and impact assessment, if any, for the projects undertaken by the company.

Provided that the Board may alter such plan at any time during the financial year, as per the recommendations of the Corporate Social Responsibility Committee, based on the reasonable justification to that effect.

4. Monitor the corporate social responsibility policy of the Company and its implementation from time to time ; and
5. Any other matter as the Corporate Social Responsibility Committee may deem appropriate after approval of the Board or as may be directed by the Board from time to time and / or as may be required under applicable law, as and when amended from time to time.

Management Organisation Structure

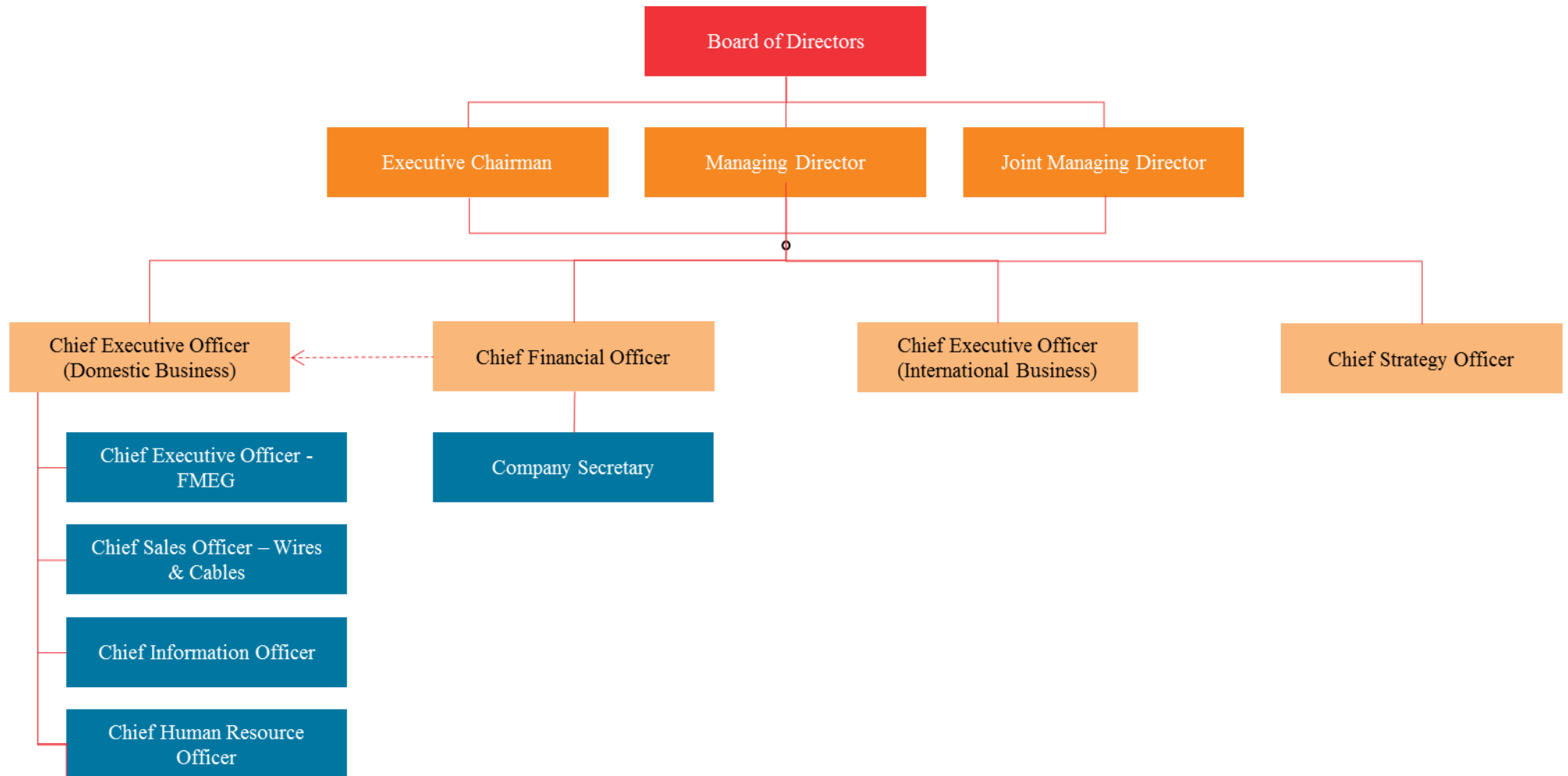

Key Managerial Personnel

The details of our Key Managerial Personnel, as on the date of this Red Herring Prospectus are as follows:

Tribhuvanprasad Rameshwarlal Kabra is the Executive Chairman of our Company, **Shreegopal Rameshwarlal Kabra** is the Managing Director of our Company and **Mahendrakumar Rameshwarlal Kabra** is the Joint Managing Director of our Company. For details, see “– *Brief Biographies of our Directors*” on page 245. For details of compensation paid to them during Financial Year 2023, see “– *Payment or benefit to Directors of our Company – Remuneration to our Executive Directors*” on page 247.

Rajesh Babu Jain is the Chief Financial Officer of our Company. He joined our Company on July 1, 2000 and is responsible for heading the financial functions of the Company including leading various initiatives in the organisation of business excellence and operational efficiency of the Company. He holds a degree of bachelor’s in commerce from Mohanlal Sukhadia University, Udaipur. He has also qualified as an associate from the Institute of Cost and Works Accountants of India and enrolled as a licentiate of the Institute of Company Secretaries of India. Previously, he has worked with Harshvardhan Chemicals and Minerals Limited. During Financial Year 2023, he received a remuneration of ₹12.09 million.

Dinesh Aggarwal is the Chief Executive Officer of our Company. He joined our Company on December 16, 2022 and is responsible for handling the domestic business administration of the Company. He holds a degree of bachelor’s in science from Kurukshetra University and a post graduate diploma in management from Indian Institute of Management, Calcutta. Previously, he has worked with Anchor Electronics and Electricals Private Limited, Panasonic Life Solutions India Private Limited, Net4India Limited, Voltas Limited, DSQ world.com Limited, Antarix e-Applications Limited and Forbes Gokak Limited. During Financial Year 2023, he received a remuneration of ₹7.04 million.

Himanshu Navinchandra Parmar is the Company Secretary and Compliance Officer of our Company. He joined our Company on June 1, 2013 and is responsible for secretarial and legal functions of the Company. He holds a degree of bachelor’s in law and bachelor’s in commerce from the Maharaja Sayajirao University of Baroda and is also a fellow member of the Institute of Company Secretaries of India. Previously, he has worked with MEW Electricals Limited. During Financial Year 2023, he received a remuneration of ₹2.75 million.

Senior Management Personnel

The details of our Senior Management Personnel, as on the date of this Red Herring Prospectus are as follows:

Sanjay Narnarayan Taparua is the chief executive officer of international business of our Company. He joined our Company on November 12, 2010 and is responsible for expansion of international business and export of products. He holds a degree of bachelor’s in science from the University of Bombay. Previously, he has worked with Ram Ratna International as a director. During Financial Year 2023, he received a remuneration of ₹13.38 million.

Satishkumar Anandilal Agarwal is the chief strategy officer of our company. He joined our Company on March 1, 2023 and is responsible for private equity investments, mergers and acquisitions. He was also associated with our Company as a chief advisor to chairman/ managing director’s office for over 2 years. He has passed the examinations for the degree of bachelor’s in commerce from the University of Bombay. He is also a qualified chartered accountant from Institute of Chartered Accountants of India. Previously, he has worked with Ram Ratna Wires Limited. During Financial Year 2023, he received a remuneration of ₹0.65 million.

Shishir Sharma is the chief sales officer of the wires and cables division of our company. He joined our Company on December 1, 2008 and is responsible for heading sales and marketing division of the Company. He holds a degree of bachelor’s in science from the Maharaja Sayajirao University of Baroda. He has previously worked with Godrej-GE Appliances Limited, Whirlpool of India Limited and Electrolux Voltas Limited. During Financial Year 2023, he received a remuneration of ₹10.03 million.

Vinod Parur is the chief human resources officer of our company. He joined our Company on November 1, 2021 and is responsible for human resources planning, talent management and development, performance management, leadership development, training and development, assessment and certification, employee relations. He holds a degree of bachelor’s in commerce from Narsee Monjee College of Commerce and Economics, University of Mumbai and a master’s in management studies from Mahatma Education Society’s Pillai’s Institute of Management Studies and Research, University of Mumbai. Previously, he has worked with Hindustan Construction Company Limited, Unichem Laboratories Limited, Schindler India Private Limited, A.T.E. Enterprises Private Limited and Nilkamal Limited. During Financial Year 2023, he received a remuneration of ₹9.60 million.

Vivek Abrol is the chief executive officer of consumer business (FMEG division) of our company. He joined our Company on June 1, 2021 and is responsible for building, structuring and acquiring new consumer business for the Company. He holds a degree of bachelor’s in mechanical engineering from Dr. Babasaheb Ambedkar Marathwada University and master’s in management from University of Mumbai. Previously, he has worked with ITC Limited and Pidilite Industries Limited. During Financial Year 2023, he received a remuneration of ₹17.74 million.

Confirmations

Except as disclosed in “ – *Relationship between our Directors*”, none of our Directors are related to any of our Key Managerial Personnel or Senior Management Personnel and none of our Key Managerial Personnel or Senior Management Personnel are related to each other.

All our Key Managerial Personnel and Senior Management Personnel are permanent employees of our Company.

There is no arrangement or understanding with the major shareholders, customers, suppliers or others, pursuant to which any of our other Key Managerial Personnel or Senior Management Personnel were selected as a key managerial personnel or senior management personnel.

Interest of Key Managerial Personnel and Senior Management Personnel

None of the Key Managerial Personnel or Senior Management Personnel of our Company have any interests in our Company other than as disclosed in “ - *Interests of Directors*” and to the extent of the remuneration or benefits to which they are entitled to as per their terms of appointment and reimbursement of expenses incurred by them during the ordinary course of business.

There is no contingent or deferred compensation accrued for the year payable to the Key Managerial Personnel or Senior Management Personnel, even if the compensation is payable at a later date.

No loans have been availed by our Key Management Personnel or Senior Management Personnel from our Company as on the date of this Red Herring Prospectus.

For further details of the interest of our Executive Directors in our Company, see “ – *Interests of Directors*” on page 248.

Bonus or profit-sharing plans for our Key Managerial Personnel or Senior Management Personnel

Other than as disclosed in “ - *Bonus or profit-sharing plan of the Directors*”, and the annual variable payments which our Key Managerial Personnel or Senior Management Personnel are entitled to, our Key Managerial Personnel or Senior Management Personnel are not parties to any bonus or profit-sharing plan of our Company.

Shareholding of our Key Managerial Personnel or Senior Management Personnel in our Company

Other than as disclosed in “ - *Shareholding of Directors in our Company*” and Rajesh Babu Jain who holds 8,000 Equity Shares, Himanshu Navinchandra Parmar who holds 1,200 Equity Shares, Satishkumar Anandilal Agarwal who holds 5,000 Equity Shares, Shishir Sharma who holds 42,000 Equity Shares, Vinod Parur who holds 1,000 Equity Shares and Sanjay Narnarayan Taparia who holds 300,000 Equity Shares, of our Company, none of our Key Managerial Personnel or Senior Management Personnel hold any Equity Shares. Further, for the details in relation to the ESOPs held by the Key Managerial Personnel and Senior Managerial Personnel, see “ *Capital Structure - Employee Stock Option Schemes of our Company*” on page 106.

Changes in our Key Managerial Personnel and Senior Management Personnel in the three immediately preceding years

Details of the changes in our Key Managerial Personnel and Senior Management Personnel in the three immediately preceding years are set forth below.

Name	Date of change	Reason for change
Hemal Savla	April 29, 2023	Resigned as chief information officer
Satishkumar Anandilal Agarwal	March 1, 2023	Appointed as chief strategy officer
Sanjay Narnarayan Taparia	December 16, 2022	Appointed as president- international business
Dinesh Aggarwal	December 16, 2022	Appointed as Chief Executive Officer
Shishir Sharma	March 1, 2022	Appointed as chief sales officer
Rajesh Babu Jain	August 24, 2022	Appointed as Chief Financial Officer
Rajeev Pandiya	August 23, 2022	Resigned as chief financial officer
Joydeep Mukherjee	December 16, 2021	Resigned as chief operating officer
Hemal Savla	November 8, 2021	Appointed as chief information officer
Vinod Parur	November 1, 2021	Appointed as chief human resources officer
Vivek Abrol	June 1, 2021	Appointed as Chief Executive Officer - FMEG
Rajeev Pandiya	April 1, 2021	Appointed as chief financial officer
Partha Chakraborti	March 31, 2021	Resigned as chief financial officer

Note: This does not include changes in designations.

The attrition of the Key Managerial Personnel and Senior Management Personnel of our Company is not high compared to the industry. For details, see “ *Risk Factors- Internal Risk Factors- We are highly dependent on our Key Managerial Personnel and our Senior Management Personnel for our business. The loss of or our inability to attract or retain such persons could have a material adverse effect on our business performance*” on page 42.

Payment or benefit to officers of our Company

Except statutory entitlements for benefits upon termination of their employment in our Company or retirement, no officer of our Company, including our Directors, Key Managerial Personnel, Senior Management Personnel, is entitled to any benefits upon termination of employment under any service contract entered into with our Company.

Except as disclosed in “ – *Interests of Directors*” on page 248 and stated otherwise in this Red Herring Prospectus and any statutory payments made by our Company, no amount or benefits in kind has been paid or given, in the two years preceding the date of this Red Herring Prospectus, or is intended to be paid or given to any of our Company’s officers including the Key Managerial Personnel and Senior Management Personnel except remuneration and re-imbursments for services rendered as Directors, officers or employees of our Company.

Employee stock option schemes

For details of the ESOP Schemes and grant of options made thereunder, see *Capital Structure – Employee Stock Option Schemes of our Company*” on page 106.

OUR PROMOTERS AND PROMOTER GROUP

The Promoters of our Company are Tribhuvanprasad Rameshwarlal Kabra, Shreegopal Rameshwarlal Kabra, Mahendrakumar Rameshwarlal Kabra, Kirtidevi Shreegopal Kabra, Tribhuvanprasad Kabra HUF, Kabra Shreegopal Rameshwarlal HUF and Mahendra Kumar Kabra HUF.

As on the date of this Red Herring Prospectus, our Promoters, in aggregate, hold 32,382,385 Equity Shares representing 29.14% of the issued, subscribed and paid-up Equity Share capital of our Company on a fully diluted basis. For further details, see “*Capital Structure - Shareholding of our Promoters and Promoter Group*” on page 100.

Details of our Promoters



Tribhuvanprasad Rameshwarlal Kabra, aged 68 years, is one of the Promoters and the Executive Chairman on our Board. For a complete profile of Tribhuvanprasad Rameshwarlal Kabra, i.e., his date of birth, personal address, educational qualifications, business experience, positions/ posts held in the past and other directorships, special achievements, business and other activities, see “*Our Management*” beginning on page 243.

His PAN is AADPK2978A.



Shreegopal Rameshwarlal Kabra, aged 65 years, is one of the Promoters and the Managing Director on our Board. For a complete profile of Shreegopal Rameshwarlal Kabra, i.e., his date of birth, personal address, educational qualifications, business experience, positions/ posts held in the past and other directorships, special achievements, business and other activities, see “*Our Management*” beginning on page 243.

His PAN is AADPK4904G.



Mahendrakumar Rameshwarlal Kabra, aged 66 years, is one of the Promoters and the Joint Managing Director on our Board. For a complete profile of Mahendrakumar Rameshwarlal Kabra, i.e., his date of birth, personal address, educational qualifications, business experience, positions/ posts held in the past and other directorships, special achievements, business and other activities, see “*Our Management*” beginning on page 243.

His PAN is AADPK3514C.



Kirtidevi Shreegopal Kabra, aged 61 years, is one of the Promoters of our Company.

Date of Birth: February 23, 1962

Address: Ishan, 9th, 10th Floor, Plot no. 547, Jame Jamshed Road, near Five Garden, Matunga Central, Mumbai 400 019, Maharashtra, India.

She holds a bachelor’s degree in commerce from Karnatak University. She has led the corporate publicity, branding and communication function of our Company since 1995. Previously, she was associated with Ram Ratna Wires Limited and MEW Electricals Limited each as a director.

Her PAN is AAHPK2240D.

Tribhuvanprasad Kabra HUF

Tribhuvanprasad Kabra HUF was formed as a Hindu undivided family, with its office at Ram Ratna House, Oasis Complex, PB Marg, Worli, Mumbai 400 013, Maharashtra, India. Tribhuvanprasad Rameshwarlal Kabra is the karta of the HUF. Its PAN is AADHK3395M.

The members of Tribhuvanprasad Kabra HUF are:

Name	Designation in HUF	Relationship with karta
Tribhuvanprasad Rameshwarlal Kabra	Karta	N.A.
Mahhesh Tribhuvanprasad Kabra	Coparcener	Son
Sarita Jhawar	Coparcener	Daughter
Deves Kabra	Member	Grandson
Shubham Jhawar	Member	Grandson
Janvi Kabra	Member	Granddaughter
Suhani Jhawar	Member	Granddaughter

Kabra Shreegopal Rameshwarlal HUF

Kabra Shreegopal Rameshwarlal HUF was formed as a Hindu undivided family, with its office at Ram Ratna House, Oasis Complex, PB Marg, Worli, Mumbai 400 013, Maharashtra, India. Shreegopal Rameshwarlal Kabra is the karta of the HUF. Its PAN is AAAHK0872L.

The members of Kabra Shreegopal Rameshwarlal HUF are:

Name	Designation in HUF	Relationship with karta
Shreegopal Rameshwarlal Kabra	Karta	N.A.
Kirtidevi Shreegopal Kabra	Coparcener	Wife
Rajesh Shreegopal Kabra	Coparcener	Son
Priti Amit Saboo	Coparcener	Daughter
Asha Muchhal	Coparcener	Daughter
Arjun Kabra	Member	Grandson
Ivaan Kabra	Member	Grandson
Manav Saboo	Member	Grandson
Naavya Muchhal	Member	Granddaughter
Nitya Muchhal	Member	Granddaughter

Our Company confirms that the PANs, bank account numbers, passport numbers, Aadhaar card numbers and driving license numbers of our individual Promoters and the PANs and bank account numbers of Tribhuvanprasad Kabra HUF, Mahendra Kumar Kabra HUF and Kabra Shreegopal Rameshwarlal HUF have been submitted to the Stock Exchanges, at the time of filing of the Draft Red Herring Prospectus. Tribhuvanprasad Rameshwarlal Kabra and Kirtidevi Shreegopal Kabra do not hold a valid driving license as on the date of filing of this Red Herring Prospectus.

Mahendra Kumar Kabra HUF

Mahendra Kumar Kabra HUF was formed as a Hindu undivided family, with its office at Ram Ratna House, Oasis Complex, PB Marg, Worli, Mumbai 400 013, Maharashtra, India. Mahendrakumar Rameshwarlal Kabra is the karta of the HUF. Its PAN is AAAHM0653B.

The members of Mahendra Kumar Kabra HUF are:

Name	Designation in HUF	Relationship with karta
Mahendrakumar Rameshwarlal Kabra	Karta	N.A.
Sumeet Mahendrakumar Kabra	Coparcener	Son
Hemant Mahendrakumar Kabra	Coparcener	Son
Saaransh Kabra	Member	Grandson
Saumya Kabra	Member	Granddaughter
Samaya Kabra	Member	Granddaughter
Vaani Kabra	Member	Granddaughter
Veda Kabra	Member	Granddaughter

Interests of Promoters and Common Pursuits

Our Promoters are interested in our Company to the extent that (i) they have promoted our Company; (ii) to the extent of their shareholding and shareholding of the members of the Promoter Group, in our Company; and (iii) the dividend payable, if any, and any other distributions in respect of the Equity Shares held by them in our Company, from time to time. For details of the shareholding of our Promoters in our Company, see “*Capital Structure*”, beginning on page 81.

Certain of our Promoters, who are also Directors, may be deemed to be interested to the extent of their remuneration/sitting fees and reimbursement of expenses, payable to them, if any in their capacity as Directors. For further details, see “*Our Management – Payment or benefit to Directors of our Company – Remuneration to our Executive Directors*” and “*Our Management – Interests of Directors*” on pages 247 and 248, respectively.

Except for Kabra Shreegopal Rameshwarlal HUF, with whom our Company has entered into two leave and license agreements each dated March 31, 2022 in relation to our Registered Office, our Promoters have no interest in any property acquired by our Company during the three years immediately preceding the date of this Red Herring Prospectus or proposed to be acquired by our Company, or in any transaction by our Company for acquisition of land, construction of building or supply of machinery.

However, our Company has agreed to purchase land from two of our Group Companies, namely (i) Ram Ratna Wires Limited, of which our Promoters, Shreegopal Rameshwarlal Kabra and Kirtidevi Shreegopal Kabra are promoters, and Tribhuvanprasad Rameshwarlal Kabra and Mahendrakumar Rameshwarlal Kabra are directors; and (ii) MEW Electricals Limited, of which Shreegopal Rameshwarlal Kabra and Kirtidevi Shreegopal Kabra are promoters. For details, see “*Our Group Companies – Nature and extent of interest of our Group Companies – In the properties acquired by our Company in the past three years before filing of this Red Herring Prospectus or proposed to be acquired by our Company*” on page 267. Further, our Company has also purchased land in Waghodia from MEW Electricals Limited, of which Shreegopal Rameshwarlal Kabra and Kirtidevi Shreegopal Kabra are promoters. For details, see “*Our Group Companies – Nature and extent of interest of our Group Companies – In transactions for acquisition of land, construction of building and supply of machinery, etc.*” on page 267.

No sum has been paid or agreed to be paid to any of our Promoters or to the firms or companies in which our Promoters are interested as members in cash or shares or otherwise by any person, either to induce them to become or to qualify them, as directors or promoters or otherwise for services rendered by our Promoters or by such firms or companies in connection with the promotion or formation of our Company.

Except in the ordinary course of business and as disclosed in “*Other Financial Information - Related Party Transactions*” and see “*Restated Consolidated Financial Information – Annexure VI – Notes to Restated Consolidated Financial Information Note 33: Related party disclosures as required under Ind AS-24*” on pages 375 and 330, respectively, no amount or benefit has been paid or given to our Promoters or any of the members of the Promoter Group during the two years preceding the filing of this Red Herring Prospectus nor is there any intention to pay or give any amount or benefit to our Promoters or any of the members of the Promoter Group.

Other than as disclosed in this section under “– *Entities forming part of the Promoter Group*” on page 263 and in “*Our Management*” beginning on page 243, our Promoters are not involved in any ventures in the same line of activity or business as that of our Company.

Other ventures of our Promoters

Other than as disclosed in this section under “– *Entities forming part of the Promoter Group*” on page 263 and in “*Our Management*” beginning on page 243, our Promoters are not involved in any other ventures.

Material guarantees given by our Promoters to third parties with respect to Equity Shares of our Company

Our Promoters have not given any material guarantee to any third party with respect to the Equity Shares as on the date of this Red Herring Prospectus.

Companies and firms with which our Promoters have disassociated in the last three years

Except as disclosed below, our Promoters have not disassociated with any company or firm in the last three years as on the date of this Red Herring Prospectus.

Name of the Promoter	Name of the company or firm from which the Promoters have disassociated	Reasons for and circumstances leading to disassociation	Date of disassociation
Shreegopal Rameshwarlal Kabra	Kabel Buildcon Solutions Private Limited	Divestment of stake by way of sale	November 2, 2021
Kirtidevi Shreegopal Kabra			
Kabra Shreegopal Rameshwarlal HUF			
Mahendrakumar Rameshwarlal Kabra	World Electrical Hub Private Limited	Transfer of stake by way of gift	April 4, 2021
Tribhuvanprasad Rameshwarlal Kabra	Ram Ratna Infrastructure Private Limited	Transfer of stake by way of gift	April 3, 2021
Mahendrakumar Rameshwarlal Kabra			
Tribhuvanprasad Kabra HUF			
Tribhuvanprasad Rameshwarlal Kabra	Ram Ratna Research and Holdings Private Limited	Transfer of stake by way of gift	April 3, 2021
Shreegopal Rameshwarlal Kabra			
Kirtidevi Shreegopal Kabra			
Tribhuvanprasad Kabra HUF			
Kabra Shreegopal Rameshwarlal HUF			
Tribhuvanprasad Rameshwarlal Kabra	RR Parkon Private Limited	Transfer of stake by way of gift	April 3, 2021
Mahendra Kumar Kabra HUF			
Tribhuvanprasad Rameshwarlal Kabra	Jag-Bid Finvest Private Limited	Transfer of stake by way of gift	April 3, 2021

Name of the Promoter	Name of the company or firm from which the Promoters have disassociated	Reasons for and circumstances leading to disassociation	Date of disassociation
Shreegopal Rameshwarlal Kabra			
Kirtidevi Shreegopal Kabra			
Kabra Shreegopal Rameshwarlal HUF			
Kirtidevi Shreegopal Kabra	Pratik Wire & Cable Machines Private Limited	Transfer of stake by way of gift	April 3, 2021
Tribhuvanprasad Rameshwarlal Kabra	Kabra Global	Dissolution of partnership firm	March 31, 2021
Mahendrakumar Rameshwarlal Kabra			
Kirtidevi Shreegopal Kabra			

Confirmations

Our Promoters have not been declared wilful defaulters or fraudulent borrowers by any bank or financial institution (as defined under the Companies Act, 2013) or consortium thereof, in accordance with the guidelines on wilful defaulters or fraudulent borrowers issued by the Reserve Bank of India. Our Promoters have not been declared as fugitive economic offenders under Section 12 of the Fugitive Economic Offenders Act, 2018.

Our Promoters and members of our Promoter Group have not been prohibited or debarred from accessing the capital markets or debarred from buying, selling or dealing in securities under any order or direction passed by SEBI or any other securities market regulator or any other authority, court or tribunal inside and outside India.

Our Promoters are not promoters or directors of any other company which is prohibited or debarred from accessing the capital markets or debarred from buying, selling or dealing in securities under any order or direction passed by SEBI or any other securities market regulator or any other authority, court or tribunal inside and outside India.

Change in the control of our Company

There has not been any change in the control of our Company during the last five years preceding the date of this Red Herring Prospectus.

Promoter Group

The following individuals and entities constitute our Promoter Group in terms of Regulation 2(1)(pp) of the SEBI ICDR Regulations.

Natural persons who are part of our Promoter Group

The following table sets forth details of the natural persons who are part of our Promoter Group (due to their relationship with our Promoters):

Sr. No.	Member of the Promoter Group	Relationship with Promoters
1.	Rameshwarlal Jagannath Kabra	Father of Tribhuvanprasad Rameshwarlal Kabra, Mahendrakumar Rameshwarlal Kabra and Shreegopal Rameshwarlal Kabra
2.	Ratnadevi Rameshwarlal Kabra	Mother of Tribhuvanprasad Rameshwarlal Kabra, Mahendrakumar Rameshwarlal Kabra and Shreegopal Rameshwarlal Kabra
3.	Mahhesh Tribhuvanprasad Kabra	Son of Tribhuvanprasad Rameshwarlal Kabra
4.	Sarita Jhavar	Daughter of Tribhuvanprasad Rameshwarlal Kabra
5.	Saraswatidevi Satyanarayan Loya	Mother-in-law of Tribhuvanprasad Rameshwarlal Kabra
6.	Anant Satyanarayan Loya	Brother-in-law of Tribhuvanprasad Rameshwarlal Kabra
7.	Gaurishankar Satyanarayan Loya	Brother-in-law of Tribhuvanprasad Rameshwarlal Kabra
8.	Pushpa Lahoti	Sister-in-law of Tribhuvanprasad Rameshwarlal Kabra
9.	Sumeet Mahendrakumar Kabra	Son of Mahendrakumar Rameshwarlal Kabra
10.	Hemant Mahendrakumar Kabra	Son of Mahendrakumar Rameshwarlal Kabra
11.	Shrigopal Devkisan Jakhotia	Brother-in-law of Mahendrakumar Rameshwarlal Kabra
12.	Omprakash D Jakhotia	Brother-in-law of Mahendrakumar Rameshwarlal Kabra
13.	Rajesh Shreegopal Kabra	Son of Shreegopal Rameshwarlal Kabra and Kirtidevi Shreegopal Kabra
14.	Priti Amit Saboo	Daughter of Shreegopal Rameshwarlal Kabra and Kirtidevi Shreegopal Kabra
15.	Asha Muchhal	Daughter of Shreegopal Rameshwarlal Kabra and Kirtidevi Shreegopal Kabra
16.	Sushilkumar Nandlal Baheti	Brother-in-law of Shreegopal Rameshwarlal Kabra and brother of Kirtidevi Shreegopal Kabra
17.	Kiran Bajaj	Sister-in-law of Shreegopal Rameshwarlal Kabra and sister of Kirtidevi Shreegopal Kabra
18.	Kavita Sanjay Karwa	Sister-in-law of Shreegopal Rameshwarlal Kabra and sister of Kirtidevi Shreegopal Kabra
19.	Kishori Dinesh Modani	Sister-in-law of Shreegopal Rameshwarlal Kabra and sister of Kirtidevi Shreegopal Kabra

Entities forming part of our Promoter Group

1. Albelo Agencies
2. Amit Saboo HUF
3. Bgauss Auto Private Limited
4. Brown Multichem Private Limited
5. Electric Link Pan Africa Ltd
6. Essence & Essential Private Limited
7. Experiences Club LLP
8. Gallery Retail LLP
9. Gaurishankar Satyanarayan Loya HUF
10. Hertz Controls
11. Jag-Bid Finvest Private Limited
12. Kabel Buildcon Realty LLP
13. Kabel Buildcon Solutions Private Limited
14. KGR 360 Solutions LLP
15. KGR Electro Build Private Limited
16. KGR Worldwide Solutions LLP
17. KVR Agencies
18. Loyalty Realty LLP
19. Mahhesh Kabra HUF
20. Makewise Ventures LLP
21. Meflab Biotech LLP
22. MSH Venture LLP
23. NAV Wireless Technologies Private Limited
24. Oz HRMS Solution Private Limited
25. Paarth Clothing Private Limited
26. Pap-Print (India) Private Limited
27. Pournima Reality Private Limited
28. Ram Ratna Infrastructure Private Limited
29. Ram Ratna International
30. Ram Ratna International LLP
31. Ram Ratna Research and Holdings Private Limited
32. RR Busduct Power Distribution Equipment Manufacturing LLC
33. RR Busduct Private Limited
34. RR Middle East FZCO

35. RR Parkon Private Limited
36. S Jhwar Tradecom LLP
37. Sanjay Rameshwar Karwa HUF
38. Scubes Management Consulting LLP
39. Satyanarayan Mohanlal Loya HUF
40. Sushilkumar Nandlal Baheti HUF
41. TMG Global FZCO
42. Upper Edge Media Solutions Private Limited
43. Venugopal Bajaj HUF
44. World Electrical Hub Private Limited
45. Xplorebee Private Limited

OUR GROUP COMPANIES

In terms of the SEBI ICDR Regulations and the applicable accounting standards, 'group companies' of our Company shall include (i) the companies (other than our subsidiaries and corporate promoters, as applicable) with which there were related party transactions, in accordance with Ind AS 24, as disclosed in the Restated Consolidated Financial Information ("**Relevant Period**"), including any additions or deletions in such companies, after the Relevant Period and until the date of the respective Offer documents; and (ii) such other companies as considered material by the Board.

With respect to (ii) above, our Board in its meeting held on May 3, 2023 has considered that such companies (other than our subsidiaries and corporate promoters, as applicable) that are a part of the Promoter Group with which there were transactions in the most recent financial year and stub period, if any, to be included in the Offer documents ("**Test Period**"), and which individually or in the aggregate, exceed 10% of the total restated consolidated revenue of our Company for the Test Period, shall also be classified as Group Companies.

Accordingly, based on the parameters outlined above, as on the date of this Red Herring Prospectus, our Company has the following Group Companies:

1. Epavo Electricals Private Limited;
2. Global Copper Private Limited;
3. Jag-Bid Finvest Private Limited;
4. Kabel Buildcon Solutions Private Limited;
5. MEW Electricals Limited;
6. Pratik Wire & Cable Machines Private Limited;
7. Ram Ratna Infrastructure Private Limited;
8. Ram Ratna Research and Holdings Private Limited;
9. Ram Ratna Wires Limited; and
10. R R Imperial Electricals Limited.

In accordance with the SEBI ICDR Regulations, certain financial information in relation to our Group Companies for the previous three financial years, extracted from their respective audited financial statements (as applicable) are available at the websites indicated below.

Details of our top five Group Companies

Our top five Group companies in accordance with the SEBI ICDR Regulations comprise of Ram Ratna Wires Limited, a listed company, and MEW Electricals Limited, Global Copper Private Limited, Ram Ratna Infrastructure Private Limited and R R Imperials Electricals Limited, which are our largest unlisted Group Companies on the basis of turnover as per their last audited financial statements. In accordance with the SEBI ICDR Regulations, details of our top five Group Companies have been set out below and certain financial information in relation to these entities for the previous three financial years, extracted from their respective audited financial statements is available at the websites indicated below.

1. ***Ram Ratna Wires Limited ("RRWL")***

Registered Office

The registered office of RRWL is situated at Ram Ratna House, Victoria Mill Compound, Pandurang Budhkar Marg, Worli, Mumbai 400 013, Maharashtra, India.

Financial information

Certain financial information derived from the audited financial statements of RRWL for Fiscals 2023, 2022 and 2021, as required by the SEBI ICDR Regulations, is available on the website of RRWL at www.rreshramik.com.

2. ***MEW Electricals Limited ("MEL")***

Registered Office

The registered office of MEL is situated at Plot No. 26/329/330-C1B, 24-25A, GIDC Estate, Waghodia, Vadodara 391 760, Gujarat, India.

Financial information

Certain financial information derived from the audited financial statements of MEL for Fiscals 2023, 2022 and 2021, as required by the SEBI ICDR Regulations, is available on the website of our Company at www.rrkabel.com/investor-relations/reports.

3. *Global Copper Private Limited (“GCPL”)*

Registered Office

The registered office of GCPL is situated at Survey No. 65-66, Garadia Village, Jarod Samlaya Road, Ta Savli District, Vadodara 391 520, Gujarat, India.

Financial information

Certain financial information derived from the audited financial statements of GCPL for Fiscals 2023, 2022 and 2021, as required by the SEBI ICDR Regulations, is available on the website of its holding company, RRWL at www.rrshramik.com.

4. *Ram Ratna Infrastructure Private Limited (“RRIPL”)*

Registered Office

The registered office of RRIPL is situated at Ram Ratna House, Victoria Mill Compound, Pandurang Budhkar Marg, Worli, Mumbai 400 013, Maharashtra, India.

Financial information

Certain financial information derived from the audited financial statements of RRIPL for Fiscals 2022, 2021 and 2020 as required by the SEBI ICDR Regulations, is available at www.rrparkon.com/other-financial-information.

5. *R R Imperial Electricals Limited (“RRIEL”)*

Registered Office

The registered office of RRIEL is situated at Plot No-50, Block-C, Fisons Road, Charagali, Tongi, Gazipur, Bangladesh.

Financial information

Certain financial information derived from the audited financial statements of RRIEL for Fiscals 2023, 2022 and 2021, as required by the SEBI ICDR Regulations, is available at www.rrshramik.com/investor/annual-reports/.

Details of other Group Companies

1. *Epavo Electricals Private Limited (“EEPL”)*

The registered office of EEPL is situated at Ram Ratna House, Victoria Mill Compound, Pandurang Budhkar Marg, Worli, Mumbai 400 013, Maharashtra, India.

2. *Jag-Bid Finvest Private Limited (“JBFPL”)*

The registered office of JBFPL is situated at Ram Ratna House, Victoria Mill Compound, Pandurang Budhkar Marg, Worli, Mumbai 400 013, Maharashtra, India.

3. *Kabel Buildcon Solutions Private Limited (“KBSPL”)*

The registered office of KBSPL is situated at Office No. 3, Alembic Business Park (West), Ground Floor, Bhailal Amin Marg, Gorwa, Vadodara 390 003, Gujarat, India

4. *Pratik Wire & Cable Machines Private Limited (“PWC MPL”)*

The registered office of PWC MPL is situated at Plot No. 1427, Phase – II GIDC Industrial Estate, Waghodia, Vadodara 391 760, Gujarat, India.

5. *Ram Ratna Research and Holdings Private Limited (“RRRHPL”)*

The registered office of RRRHPL is situated at Ram Ratna House, Victoria Mill Compound, Pandurang Budhkar Marg, Worli, Mumbai 400 013, Maharashtra, India.

Nature and extent of interest of our Group Companies

In the promotion of our Company

None of our Group Companies have an interest in the promotion of our Company.

In the properties acquired by our Company in the past three years before filing this Red Herring Prospectus or proposed to be acquired by our Company

Except as disclosed in “*Restated Consolidated Financial Information – Annexure VI – Notes to Restated Consolidated Financial Information Note 33: Related party disclosures as required under Ind AS-24*” on page 330 and in relation to (i) RRWL, from whom our Company has agreed to purchase land measuring approximately 34,358 square metres in Silvassa for a total consideration of ₹135.71 million pursuant to two agreements for sale each dated March 7, 2023, subsequent to which our Company entered into a sale deed dated August 18, 2023 for the purchase of land measuring approximately 20,353 square metres in Karad, Dadra and Nagar Haveli for a total consideration of ₹80.39 million from Ram Ratna Wires Limited, and (ii) MEL, from whom our Company has agreed to purchase land measuring approximately 4,149 square metres in Waghodia for a consideration of ₹8.50 million pursuant to a resolution passed by the Board on September 2, 2021, none of our Group Companies are interested in the properties acquired by our Company in the three years preceding the filing of this Red Herring Prospectus or proposed to be acquired by our Company.

In transactions for acquisition of land, construction of building and supply of machinery, etc.

Except as disclosed above and the purchase of land measuring approximately 47,652 square metres in Waghodia for a consideration of ₹128.66 million from MEL by our Company pursuant to a sale deed dated January 10, 2019, none of our Group Companies are interested in any transactions for acquisition of land, construction of building or supply of machinery, etc.

Common pursuits among our Group Companies and our Company

Except for RRIEL, which operates in a similar line of business as our Company within the limits of Bangladesh, there are no common pursuits amongst our Group Companies and our Company. We do not perceive any conflicts of interest with RRIEL as RRIEL operates in a different geography. We shall adopt necessary procedures and practices as permitted by law to address any conflict of interest, if and when they may arise.

Related business transactions within our Group Companies and significance on the financial performance of our Company

Except as disclosed in “*Restated Consolidated Financial Information – Annexure VI – Notes to Restated Consolidated Financial Information Note 33: Related party disclosures as required under Ind AS-24*” on page 330, there are no other related business transactions with our Group Companies.

Litigation

As on the date of this Red Herring Prospectus, there is no pending litigation involving our Group Companies which will have a material impact on our Company.

Business interest of our Group Companies

Except in the ordinary course of business and as stated in “*Restated Consolidated Financial Information – Annexure VI – Notes to Restated Consolidated Financial Information Note 33: Related party disclosures as required under Ind AS-24*” on page 330, none of our Group Companies have any business interest in our Company.

Other confirmations

Except for RRWL, none of our Group Companies have any securities listed on any stock exchange.

DIVIDEND POLICY

The declaration and payment of dividends on our Equity Shares, if any, will be recommended by our Board of Directors and approved by our Shareholders, at their discretion, subject to the provisions of the Articles of Association and other applicable law, including the Companies Act read with the rules notified thereunder, each as amended, together with the applicable rules issued thereunder. The dividend distribution policy of our Company was adopted and approved by our Board in their meeting held on May 3, 2023 (“**Dividend Policy**”).

The declaration and payment of dividend will depend on a number of internal and external factors. Some of the internal factors on the basis of which our Company may declare dividend shall *inter alia* include profits, past dividend trends, cost of borrowings, capital expenditure plans including organic and inorganic growth opportunities and the Company’s liquidity position. The external factors on the basis of which our Company may declare the dividend shall *inter alia* include the state of economy and capital markets, applicable taxes and regulatory changes which include the introduction of new or changes in existing tax or regulatory requirements.

In addition, our ability to pay dividends may be impacted by a number of factors, including restrictive covenants under the loan or financing documents, our Company is currently a party to or may enter into from time to time. For details in relation to risks involved in this regard, see “*Risk Factors – Internal Risk Factors – Our ability to pay dividends in the future will depend on our future cash flows, working capital requirements, capital expenditures and financial condition*” on page 58.

The details of the dividend paid by our Company on the Equity Shares during the last three Fiscals and the three months ended June 30, 2023, and from July 1, 2023 till the date of this Red Herring Prospectus are given below:

(Amount in ₹ million, except share data)

Particulars	July 1, 2023 up till the date of the RHP	April 1, 2023 to June 30, 2023	Fiscal 2023	Fiscal 2022	Fiscal 2021
No. of equity shares	11,10,68,856 ^{#(1)}	95,696,296 [#]	23,924,074	23,924,074	23,924,074
Face value per equity share (in ₹)	5	5	10	10	10
Final dividend paid (in ₹)	-	-	430.63	239.24	-
Dividend per equity share (in ₹)*	4.50 [@]	-	18.00	10.00	-
Rate of dividend (%) ^{\$}	-	-	180	100	-
Mode of payment of dividend	Banking Channel	Banking Channel	Banking Channel	Banking Channel	Banking Channel
Dividend distribution tax (%)	-	-	-	-	-

Dividend per equity share = Total dividend/ Number of equity shares

[#] Pursuant to a resolution passed by our Board on March 16, 2023 and a resolution passed by the Shareholders on March 20, 2023, each equity share of face value of ₹10 each has been split into 2 Equity Shares of face value of ₹5 each

^{\$} Rate of dividend = Dividend per equity share/ Face value per equity share

[@] Pursuant to a resolution passed by our Board on August 14, 2023, a dividend of ₹4.50 per Equity Share has been recommended by our Company for all the shareholders holding Equity Shares of our Company as on September 1, 2023, subject to approval of our Shareholders in our upcoming annual general meeting on September 14, 2023.

⁽¹⁾ Includes 15,372,560 Equity Shares allotted upon conversion of 38,43,140 Preference Shares pursuant to the resolution passed by our Board at their meeting held on August 26, 2023.

The dividend declared and paid by the Company on the Preference Shares during the last three Fiscals and the three months ended June 30, 2023, and from July 1, 2023 till the date of this Red Herring Prospectus are given below, is as follows:

(Amount in ₹ million, except share data)

Particulars	July 1, 2023 up till the date of the RHP	April 1, 2023 to June 30, 2023	Fiscal 2023	Fiscal 2022	Fiscal 2021
No. of Preference Shares	- [#]	3,843,140	3,843,140	3,843,140	3,843,140
Face value per Preference Share (in ₹)	1,080.33	1,080.33	1,080.33	1,080.33	1,080.33
Final dividend paid (in ₹)	-	-	69.18	38.43	-
Dividend per Preference Share (in ₹)	-	-	18.00	10.00	-
Rate of dividend (%) ^(#)	-	-	1.67	0.93	-
Mode of payment of dividend	Banking Channel	Banking Channel	Banking Channel	Banking Channel	Banking Channel
Dividend distribution tax (%)	-	-	-	-	-

[#] In terms of the Article of Association of the Company read with the Shareholders Agreement dated July 7, 2018, the CCPS rank *pari passu* in respect of dividend with the Equity Shares.

^{\$} Rate of dividend = Dividend per equity share/ Face value per equity share..

[#] Pursuant to the resolution passed by our Board at their meeting held on August 26, 2023, 3,843,140 Preference Shares were converted to 15,372,560 Equity Shares.

SECTION V: FINANCIAL INFORMATION

RESTATED CONSOLIDATED FINANCIAL INFORMATION

(The remainder of this page is intentionally left blank)

B S R & Co. LLP

Chartered Accountants

903 Commerce House V,
Near Vodafone House, Prahaladnagar,
Corporate Road, Ahmedabad 380 051. India
Telephone: +91 (79) 7145 0001
Fax: +91 (79) 7145 0050

INDEPENDENT AUDITOR'S EXAMINATION REPORT ON RESTATED CONSOLIDATED FINANCIAL INFORMATION

The Board of Directors

R R Kabel Limited

Ram Ratna House,
Victoria Mill Compound,
Pandurang Budhkar Marg,
Worli, Mumbai- 400 013,
Maharashtra, India

Dear Sirs,

1. We B S R & Co. LLP, Chartered Accountants ("we" or "us" or "B S R") have examined the attached Restated Consolidated Financial Information of R R Kabel Limited (the "Company" or the "Issuer"), and its joint venture, comprising the Restated Consolidated Statement of Assets and Liabilities as at 30 June 2023, 30 June 2022, 31 March 2023, 31 March 2022 and 31 March 2021, the Restated Consolidated Statement of Profit and Loss (including other comprehensive income), the Restated Consolidated Statement of Changes in Equity, the Restated Consolidated Statement of Cash Flows for the three month periods ended 30 June 2023 and 30 June 2022, and for the years ended 31 March 2023, 31 March 2022 and 31 March 2021, the Summary Statement of Material Accounting Policies, and other explanatory information (collectively, the "Restated Consolidated Financial Information"), as approved by the Board of Directors of the Company at their meeting held on 30 August 2023 for the purpose of inclusion in the Red Herring Prospectus ("RHP") and the Prospectus, prepared by the Company in connection with its proposed Initial Public Offer of equity shares ("IPO") prepared in terms of the requirements of:
 - a) Section 26 of Part I of Chapter III of the Companies Act, 2013 (the "Act");
 - b) The Securities and Exchange Board of India (Issue of Capital and Disclosure Requirements) Regulations, 2018, as amended ("ICDR Regulations"); and

- c) The Guidance Note on Reports in Company Prospectuses (Revised 2019) issued by the Institute of Chartered Accountants of India (“ICAI”), as amended from time to time (the “Guidance Note”).
2. The Company’s Board of Directors is responsible for the preparation of the Restated Consolidated Financial Information for the purpose of inclusion in the RHP and the Prospectus to be filed with Securities and Exchange Board of India (“SEBI”), National Stock Exchange of India Limited (“NSE”), BSE Limited (“BSE”) and Registrar of Companies, Maharashtra, situated at Mumbai (“RoC”) in connection with the proposed IPO. The Restated Consolidated Financial Information have been prepared by the management of the Company on the basis of preparation stated in note 1 of Annexure V to the Restated Consolidated Financial Information. The responsibility of Board of Directors of the Company and its joint venture includes designing, implementing and maintaining adequate internal control relevant to the preparation and presentation of the Restated Consolidated Financial Information. The respective Board of Directors are also responsible for identifying and ensuring that the Company and its joint venture complies with the Act, ICDR Regulations and the Guidance Note.
3. We have examined such Restated Consolidated Financial Information taking into consideration:
 - a) The terms of reference and terms of our engagement agreed upon with you in accordance with our engagement letter dated 21 February 2023 in connection with the proposed IPO of equity shares of the Issuer;
 - b) The Guidance Note. The Guidance Note also requires that we comply with the ethical requirements of the Code of Ethics issued by the ICAI;
 - c) Concepts of test checks and materiality to obtain reasonable assurance based on verification of evidence supporting the Restated Consolidated Financial Information; and
 - d) The requirements of Section 26 of the Act and the ICDR Regulations.

Our work was performed solely to assist you in meeting your responsibilities in relation to your compliance with the Act, the ICDR Regulations and the Guidance Note in connection with the IPO.
4. These Restated Consolidated Financial Information have been compiled by the management from:
 - a) Audited Interim Consolidated Financial Statements of the Company and its joint venture as at and for the three month periods ended 30 June 2023 and 30 June 2022 prepared in accordance with Indian Accounting Standard (Ind AS) 34 "Interim Financial Reporting", specified under section 133 of the Act and other accounting principles generally accepted in India (the “Interim Consolidated Financial Statements”) which have been approved by the Board of Directors at their meeting held on 30 August 2023.
 - b) Audited Consolidated Financial Statements of the Company and its joint venture as at and for the years ended 31 March 2023, 31 March 2022 and 31 March 2021, prepared in accordance with the Indian Accounting Standards (referred to as “Ind AS”) as prescribed under Section 133 of the Act read with Companies (Indian Accounting Standards) Rules 2015, as amended, and other accounting principles generally accepted in India, which have been approved by the Board of Directors at their meeting held on 14 August 2023, 22 June 2022 and 2 September 2021 respectively.
5. For the purpose of our examination, we have relied on:
 - a) Auditor’s report issued by us dated 30 August 2023 on the Interim Consolidated Financial

Statements of the Company and its joint venture as at and for the three month periods ended 30 June 2023 and 30 June 2022 as referred in Paragraph 4 (a) above. The auditor's report on the Interim Consolidated Financial Statements of the Company as at and for the three month periods ended 30 June 2023 and 30 June 2022 included the following Other Matter paragraph:

As at and for the three month periods ended 30 June 2023 and 30 June 2022:

The Interim Consolidated Financial Statements include the Company's share of net profit / (loss) (including other comprehensive income) of INR 6.66 million for the three months ended 30 June 2023 and INR (1.83) million for the three months ended 30 June 2022, in respect of one joint venture, whose financial statements have not been audited by us. These financial statements have been audited by other auditors whose reports have been furnished to us by the management and our opinion on the consolidated financial statements, in so far as it relates to the amounts and disclosures included in respect of this joint venture is based solely on the audit reports of other auditors.

The joint venture is located outside India whose financial statements and other financial information have been prepared in accordance with the accounting principles generally accepted in their respective country and which have been audited by other auditors under generally accepted auditing standards applicable in their respective country. The Company's management has converted the financial statements of such joint venture located outside India from accounting principles generally accepted in their respective country to accounting principles generally accepted in India. We have audited these conversion adjustments made by the Company's management. Our opinion in so far as it relates to the balances and affairs of such joint venture located outside India is based on the report of other auditor and the conversion adjustments prepared by the management of the Company and audited by us.

Our opinion on interim consolidated financial statements is not modified in respect of the above matter with respect to our reliance on the work done and report of the other auditor.

- b) Auditor's reports issued by us dated 14 August 2023, 22 June 2022 and 2 September 2021 on the audited consolidated financial statements of the Company and its joint venture as at and for the years ended 31 March 2023, 31 March 2022 and 31 March 2021 respectively as referred in Paragraph 4 (b) above. The auditor's reports on the consolidated financial statements of the Company as at and for the year ended 31 March 2023, 31 March 2022 and 31 March 2021 included the following Other Matter paragraphs

As at and for the years ended 31 March 2023, 31 March 2022 and 31 March 2021:

The consolidated financial statements include the Company's share of net profit/(loss) (including other comprehensive income) of INR 9.44 million for the year ended 31 March 2023 and INR 41.97 million for the year ended 31 March 2022 and INR 10.98 million for the year ended 31 March 2021, in respect of one joint venture, whose financial statements have not been audited by us. These financial statements have been audited by other auditors whose reports have been furnished to us by the management and our opinion on the Consolidated Financial Statements, in so far as it relates to the amounts and disclosures included in respect of this joint venture is based solely on the audit reports of other auditors.

The joint venture is located outside India whose financial statements and other financial information have been prepared in accordance with accounting principles generally accepted in their respective country and which have been audited by other auditors under generally accepted auditing standards applicable in their respective- country. The Company's management has

converted the financial statements of such joint venture located outside India from accounting principles generally accepted in their respective country to accounting principles generally accepted in India. We have audited these conversion adjustments made by the Company’s management. Our opinion in so far as it relates to the balances and affairs of such joint venture located outside India is based on the report of other auditors and the conversion adjustments prepared by the management of the Company and audited by us.

Our opinion on consolidated financial statements is not modified in respect of the above matter with respect to our reliance on the work done and report of the other auditors.

6. As indicated in our audit reports referred above:

We did not audit the financial statements of a joint venture whose share of profit or loss in its joint venture included in the consolidated financial statements, for the relevant years is tabulated below, which have been audited by Ahmed Mashuque & Co (the “Other Auditor”), and whose reports have been furnished to us by the Company’s management and our opinion on the consolidated financial statements, in so far as it relates to the amounts and disclosures included in respect of these component, is based solely on the reports of the Other Auditor:

(INR in million)

Particulars	For the three-month period ended 30 June 2023	For the three-month period ended 30 June 2022	For the year ended 31 March 2023	For the year ended 31 March 2022	For the year ended 31 March 2021
Share of profit or (loss) of joint venture net of tax	6.66	(1.83)	9.44	41.97	10.98

Our opinion on the consolidated financial statements was not modified in respect of this matter.

7. Based on our examination and according to the information and explanations given to us for the respective periods/years, we report that the Restated Consolidated Financial Information:

- a) have been prepared after incorporating adjustments for the changes in accounting policies, material errors and regrouping/reclassifications retrospectively in the financial years ended 31 March 2023, 31 March 2022 and 31 March 2021 and for the three month period ended 30 June 2022 to reflect the same accounting treatment as per the accounting policies and grouping/classifications followed as at and for the three month period ended 30 June 2023;
- b) does not contain any qualifications requiring adjustments. However, those qualifications in the Companies (Auditor’s Report) Order, 2020, Companies (Auditor’s Report) Order, 2016 issued by the Central Government of India in terms of sub section (11) of section 143 of the Act, which do not require any corrective adjustments in the Restated Consolidated Financial Information, have been disclosed in Annexure VII to the Restated Consolidated Financial Information; and
- c) have been prepared in accordance with the Act, ICDR Regulations and Guidance Note.

8. We have not audited any financial statements of the Company as of any date or for any period subsequent to 30 June 2023. Accordingly, we express no opinion on the financial position, results of operations, cash flows and statement of changes in equity of the Company as of any date or for any period subsequent to 30 June 2023.
9. The Restated Consolidated Financial Information does not reflect the effects of events that occurred subsequent to the respective dates of the reports on the Interim Consolidated Financial Statements and Audited Consolidated Financial Statements mentioned in paragraph 4 above.
10. This report should not in any way be construed as a reissuance or re-dating of any of the previous audit reports issued by us, nor should this report be construed as a new opinion on any of the financial statements referred to herein.
11. We have no responsibility to update our report for events and circumstances occurring after the date of the report.
12. Our report is intended solely for use of the Board of Directors for inclusion in the RHP and the Prospectus to be filed with SEBI, NSE, BSE and RoC in connection with the proposed IPO. Our report should not be used, referred to, or distributed for any other purpose except with our prior consent in writing. Accordingly, we do not accept or assume any liability or any duty of care for any other purpose or to any other person to whom this report is shown or into whose hands it may come without our prior consent in writing.

For B S R & Co. LLP
Chartered Accountants
Firm's Registration No: 101248W/W-100022

Place: Ahmedabad
Date: 30 August 2023

Rupen Shah
Partner
Membership No: 116240
ICAI UDIN: 23116240BGWVFJ7461

R R KABEL LIMITED
Annexure I - Restated Consolidated Statement of Assets and Liabilities

(₹ in millions)

Particulars	Note No.	As at 30 June 2023	As at 30 June 2022	As at 31 March 2023	As at 31 March 2022	As at 31 March 2021
ASSETS						
Non-current assets						
Property, plant and equipment	2A	4,538.70	4,301.96	4,488.25	3,837.06	3,859.90
Capital work-in-progress	2B	497.40	318.25	435.78	423.08	66.81
Right of use assets	2C	663.61	398.91	618.46	111.17	81.48
Other intangible assets	2D	54.26	96.81	64.86	36.65	52.75
Intangible assets under development	2D	-	-	-	6.00	4.85
Investment accounted for using equity method	3A	200.39	206.16	196.29	216.36	171.43
Financial assets						
Investments	3A	919.46	357.59	581.05	405.57	234.58
Loans	4A	1.99	0.39	2.87	0.52	0.96
Other financial assets	5A	61.29	21.63	35.76	21.72	15.90
Income tax assets (net)	6A	118.37	151.71	118.34	133.72	52.35
Other non-current assets	7A	349.32	105.57	333.35	65.99	143.34
		7,404.79	5,958.98	6,875.01	5,257.84	4,684.35
Current assets						
Inventories	8	8,592.78	8,779.49	8,601.77	7,096.21	5,340.56
Financial assets						
Investments	3B	2,792.08	2,006.99	2,849.23	2,054.74	1,960.20
Trade receivables	9	6,315.23	5,384.47	5,918.73	5,171.46	4,203.64
Cash and cash equivalents	10A	151.41	67.07	310.35	123.00	83.96
Bank balances other than cash and cash equivalents	10B	-	-	500.40	-	0.70
Loans	4B	5.20	4.48	0.60	2.20	6.48
Other financial assets	5B	176.31	88.34	89.69	118.97	34.74
Other current assets	7B	1,005.33	1,174.45	1,190.43	682.02	836.51
		19,038.34	17,505.29	19,461.20	15,248.60	12,466.79
Total assets		26,443.13	23,464.27	26,336.21	20,506.44	17,151.14
EQUITY AND LIABILITIES						
Equity						
Equity share capital	11A	478.48	239.24	478.48	239.24	239.24
Instrument entirely equity in nature	11B	4,151.86	4,151.86	4,151.86	4,151.86	4,151.86
Other equity	12	10,608.74	8,411.08	9,566.61	8,111.93	6,075.21
		15,239.08	12,802.18	14,196.95	12,503.03	10,466.31
Liabilities						
Non-current liabilities						
Financial liabilities						
Borrowings	13A	187.49	511.92	268.59	593.13	712.82
Lease liabilities	14A	613.88	358.26	564.05	82.27	52.64
Other financial liabilities	15A	21.89	19.23	21.29	-	-
Provisions	16A	153.70	82.25	140.81	71.72	60.44
Deferred tax liabilities (net)	17	191.04	125.84	148.67	131.04	78.87
Other non-current liabilities	18A	0.08	0.13	0.09	0.09	0.18
		1,168.08	1,097.63	1,143.50	878.25	904.95

R R KABEL LIMITED
Annexure I - Restated Consolidated Statement of Assets and Liabilities

(₹ in millions)

Particulars	Note No.	As at 30 June 2023	As at 30 June 2022	As at 31 March 2023	As at 31 March 2022	As at 31 March 2021
Current liabilities						
Financial liabilities						
Borrowings	13B	3,850.16	4,518.00	4,889.82	4,617.98	4,274.31
Lease liabilities	14B	83.42	48.67	81.95	32.51	30.66
Trade payables						
- total outstanding dues of micro enterprises and small enterprises	19	308.29	161.01	458.81	110.99	93.22
- total outstanding dues of creditors other than micro enterprises and small enterprises	19	4,218.88	3,643.79	3,942.48	1,567.75	1,041.81
Other financial liabilities	15B	380.87	324.15	377.72	240.49	164.82
Other current liabilities	18B	725.28	643.89	958.72	415.45	120.42
Provisions	16B	239.53	224.95	221.92	139.99	54.64
Income tax liabilities (net)	20	229.54	-	64.34	-	-
		10,035.97	9,564.46	10,995.76	7,125.16	5,779.88
Total equity and liabilities		26,443.13	23,464.27	26,336.21	20,506.44	17,151.14

The above statement should be read with Material Accounting Policies forming part of the Restated Consolidated Financial Information in Annexure V, Notes to Restated Consolidated Financial Information in Annexure VI and Statement of Adjustments to Restated Consolidated Financial Information in Annexure VII.

As per our Report of even date
For B S R & Co. LLP
 Chartered Accountants
 Firm Registration No: 101248W/W-100022

For and on behalf of the Board of Directors of
R R Kabel Limited
 CIN: U28997MH1995PLC085294

Rupen Shah
 Partner
 Membership No. 116240

Tribhuvanprasad Rameshwarlal Kabra
 Executive Chairman
 DIN : 00091375

Shreegopal Rameshwarlal Kabra
 Managing Director
 DIN : 00140598

Place: Ahmedabad
 Date: 30 August 2023

Dinesh Aggarwal
 Chief Executive Officer

Himanshu Navinchandra Parmar
 Company Secretary
 Membership No.FCS 10118

Rajesh Babu Jain
 Chief Financial Officer
 Membership No. 20811

Place: Mumbai
 Date: 30 August 2023

R R KABEL LIMITED
Annexure II - Restated Consolidated Statement of Profit and Loss

(₹ in millions)

Particulars	Note No.	For the period ended 30 June 2023	For the period ended 30 June 2022	For the year ended 31 March 2023	For the year ended 31 March 2022	For the year ended 31 March 2021
Revenue from operations	21	15,973.14	12,359.10	55,992.00	43,859.36	27,239.41
Other income	22	162.84	73.90	344.40	462.82	219.95
Total Income		16,135.98	12,433.00	56,336.40	44,322.18	27,459.36
Expenses						
Cost of materials consumed	23A	11,971.13	10,401.30	43,697.88	35,755.15	21,731.99
Purchases of stock-in-trade	23B	923.35	964.38	3,688.53	1,566.17	1,298.64
Changes in inventories of finished goods, stock-in-trade, work-in-progress and scrap	23C	160.83	(940.95)	(1,629.40)	(1,241.50)	(1,538.45)
Employee benefits expense	24	767.69	611.75	2,641.59	1,888.53	1,483.45
Finance costs	25	144.24	80.77	420.86	232.84	270.56
Depreciation and amortization expense	26	160.87	144.82	596.27	460.84	447.50
Other expenses	27	1,020.65	922.87	4,370.20	2,858.53	1,962.31
Total expenses		15,148.76	12,184.94	53,785.93	41,520.56	25,656.00
Profit before share of profit of joint venture and tax		987.22	248.06	2,550.47	2,801.62	1,803.36
Add : Share of profit/(loss) of joint venture net of tax		6.66	(1.83)	9.44	41.97	10.98
Profit before tax		993.88	246.23	2,559.91	2,843.59	1,814.34
Tax expense:	17					
Current tax		247.25	64.15	658.32	648.27	489.12
Short/(excess) provision of tax of earlier years		-	-	3.87	2.99	(7.89)
Deferred tax charge / (credit)		3.15	0.66	(1.00)	52.96	(20.87)
		250.40	64.81	661.19	704.22	460.36
Profit for the period/year		743.48	181.42	1,898.72	2,139.37	1,353.98
Other comprehensive income/(loss)						
A) Items that will not be reclassified to profit and loss						
a) (i) Re-measurement of post employment benefits obligation		(1.14)	(1.81)	(4.54)	(7.23)	4.04
(ii) Income tax relating to items that will not be reclassified to profit and loss		0.29	0.46	1.14	1.82	(1.02)
b) (i) Fair value gain/(loss) on investment in equity instrument through OCI		338.40	(47.97)	175.49	170.98	80.55
(ii) Income tax relating to items that will not be reclassified to profit and loss		(39.51)	5.40	(19.77)	(1.03)	(6.99)
B) Items that will be reclassified to profit or loss						
a) Exchange difference arising on translation of foreign operation		(2.57)	(8.37)	(29.51)	2.96	(4.70)
Total other comprehensive income/(loss) (net of tax)		295.47	(52.29)	122.81	167.50	71.88
Total comprehensive income for the period/year		1,038.95	129.13	2,021.53	2,306.87	1,425.86
Earnings per Equity Share (face value of ₹ 5 each) (not annualised for June 23 and June 22)	36					
Basic		6.69	1.63	17.09	19.26	12.19
Diluted		6.68	1.63	17.07	19.22	12.18

The above statement should be read with Material Accounting Policies forming part of the Restated Consolidated Financial Information in Annexure V, Notes to Restated Consolidated Financial Information in Annexure VI and Statement of Adjustments to Restated Consolidated Financial Information in Annexure VII.

R R KABEL LIMITED
Annexure II - Restated Consolidated Statement of Profit and Loss

As per our Report of even date
For B S R & Co. LLP
Chartered Accountants
Firm Registration No: 101248W/W-100022

For and on behalf of the Board of Directors of
R R Kabel Limited
CIN: U28997MH1995PLC085294

Rupen Shah
Partner
Membership No. 116240

Tribhuvanprasad Rameshwarlal Kabra
Executive Chairman
DIN : 00091375

Shreegopal Rameshwarlal Kabra
Managing Director
DIN : 00140598

Place: Ahmedabad
Date: 30 August 2023

Dinesh Aggarwal
Chief Executive Officer

Himanshu Navinchandra Parmar
Company Secretary
Membership No.FCS 10118

Rajesh Babu Jain
Chief Financial Officer
Membership No. 20811

Place: Mumbai
Date: 30 August 2023

R R KABEL LIMITED
Annexure III - Restated Consolidated Statement of Cash Flows

(₹ in millions)

Particulars	For the period ended 30 June 2023	For the period ended 30 June 2022	For the year ended 31 March 2023	For the year ended 31 March 2022	For the year ended 31 March 2021
(A) CASH FLOWS FROM OPERATING ACTIVITIES :					
Profit before tax	993.88	246.23	2,559.91	2,843.59	1,814.34
Adjustments for :					
Depreciation and amortization expense	160.87	144.82	596.27	460.84	447.50
Property, plant and equipment write off	0.25	-	0.83	-	-
Grant related to property, plant and equipment	(0.01)	(0.97)	(1.01)	(36.92)	(0.04)
Share of (profit)/loss from joint venture	(6.66)	1.83	(9.44)	(41.97)	(10.98)
Finance costs	144.24	80.77	420.87	232.83	270.56
Employees share based payment expenses	3.18	2.86	5.04	7.52	-
Interest income	(8.41)	(2.67)	(30.72)	(9.67)	(32.89)
Dividend income	-	-	(7.06)	(1.41)	(0.71)
Gain on sale of mutual fund investments	(7.67)	(0.41)	(8.70)	(0.04)	-
Fair value gain on investment on mutual fund	(38.47)	(12.04)	(104.34)	(94.53)	(40.02)
Allowance for / (reversal) of expected credit loss on trade receivables(net)	2.90	(7.31)	9.14	(18.07)	52.91
Bad debts	0.23	-	-	10.60	-
Reversal of provision on advances to vendor	-	(19.26)	(19.26)	-	-
Provisions for warranty expenses	12.61	78.64	96.49	75.25	21.68
Unrealised foreign exchange loss/(gain)	(28.95)	64.47	78.60	60.89	23.06
Gain on sale of property, plant and equipment	-	-	(0.80)	(20.28)	(0.87)
	1,227.99	576.96	3,585.82	3,468.63	2,544.54
Adjustments for:					
(Increase) in trade receivables	(603.63)	(34.61)	(179.30)	(959.53)	(114.70)
(Increase)/decrease in financial assets	(89.00)	(7.00)	(25.69)	(82.71)	10.02
(Increase)/decrease in other assets	135.78	(403.62)	(428.69)	164.02	(424.34)
(Increase)/decrease in inventories	8.99	(976.53)	(798.79)	(1,755.66)	(1,588.45)
Increase /(decrease) in trade payables	128.23	1,816.90	2,401.13	540.67	(667.60)
Increase /(decrease) in financial liabilities	12.54	8.96	41.02	(69.23)	(7.47)
Increase /(decrease) in other liabilities and provision	38.46	577.68	524.42	408.13	(44.05)
Cash generated from/(used in) operations	859.36	1,558.74	5,119.92	1,714.32	(292.05)
Income taxes paid (net of refund)	(82.09)	(82.14)	(582.46)	(732.62)	(418.52)
Net cash generated from/(used in) operating activities (A)	777.27	1,476.60	4,537.46	981.70	(710.57)
(B) CASH FLOWS FROM INVESTING ACTIVITIES					
Purchases of property, plant and equipment including payments towards capital advance and capital creditors	(252.19)	(228.69)	(1,083.48)	(682.25)	(474.21)
Proceeds from sale of property, plant and equipment	-	6.48	5.32	47.18	9.64
Refund of Share application money - Joint Venture	-	-	-	-	0.82
(Investment in)/Proceed from fixed deposits with banks	476.71	(2.40)	(506.63)	(2.30)	398.67
Purchase of home electrical business, net of cash acquired	-	(1,095.82)	(1,095.82)	-	-
(Investment in) / Redemption of mutual fund (net)	103.30	60.21	(681.46)	0.04	(32.00)
Dividend received from investments in quoted equity shares	-	-	7.06	1.41	0.71
Interest received	18.94	2.40	20.04	9.37	37.57
Net cash generated/(used in) Investing activities (B)	346.76	(1,257.82)	(3,334.97)	(626.55)	(58.80)
(C) CASH FLOWS FROM FINANCING ACTIVITIES					
Proceeds from non current borrowing	-	-	-	338.00	350.00
Repayment of non current borrowing	(81.10)	(100.53)	(382.02)	(75.78)	(151.32)
Proceeds from/repayment of short term borrowing (net)	(1,036.59)	(84.54)	318.40	(38.51)	863.07
Finance costs paid	(130.06)	(73.53)	(355.47)	(222.23)	(287.46)
Repayment of lease obligations	(35.22)	(16.11)	(96.24)	(39.92)	(33.04)
Dividend paid	-	-	(499.81)	(277.67)	-
Net cash (used in) / generated from financing activities (C)	(1,282.97)	(274.71)	(1,015.14)	(316.11)	741.25

R R KABEL LIMITED
Annexure III - Restated Consolidated Statement of Cash Flows

(₹ in millions)

Particulars	For the period ended 30 June 2023	For the period ended 30 June 2022	For the year ended 31 March 2023	For the year ended 31 March 2022	For the year ended 31 March 2021
(D) Net increase/(decrease) in cash and cash equivalents (A+B+C)	(158.94)	(55.93)	187.35	39.04	(28.12)
Add : Cash and cash equivalents as at the beginning of the period/year	310.35	123.00	123.00	83.96	112.08
Cash and cash equivalents as at the end of the period/year (refer note below)	151.41	67.07	310.35	123.00	83.96

Note :

- a) The above Statement of Cash Flows has been prepared under the "Indirect Method" as set out in the Indian Accounting Standard (Ind AS 7) Statement of Cash Flows.
b) Cash and cash equivalents (Note 10 A)

(₹ in millions)

Particulars	As at 30 June 2023	As at 30 June 2022	As at 31 March 2023	As at 31 March 2022	As at 31 March 2021
Cash on hand	0.36	0.32	0.37	0.33	0.51
Balance with banks	151.05	66.75	121.98	72.67	83.45
Term deposits (with original maturity of 3 months or less)	-	-	188.00	50.00	-
Cash and cash equivalents in Statement of Cash Flows	151.41	67.07	310.35	123.00	83.96

- c) Reconciliation of liabilities arising from financing activities

(₹ in millions)

Particulars	As at 31 March 2023	Cash Flow	Non Cash Changes		As at 30 June 2023
			Fair value changes/Accrued Interest	Current / Non - current classification	
Borrowings- Non Current	268.59	(81.10)	-	-	187.49
Borrowings- Current	4,889.82	(1,036.59)	(3.07)	-	3,850.16
Total	5,158.41	(1,117.69)	(3.07)	-	4,037.65

(₹ in millions)

Particulars	As at 31 March 2022	Cash Flow	Non Cash Changes		As at 30 June 2022
			Fair value changes/Accrued Interest	Current / Non - current classification	
Borrowings- Non Current	593.13	(100.53)	-	19.32	511.92
Borrowings- Current	4,617.98	(84.54)	(3.88)	(19.32)	4,518.00
Total	5,211.11	(185.07)	(3.88)	-	5,029.92

(₹ in millions)

Particulars	As at 31 March 2022	Cash Flow	Non Cash Changes		As at 31 March 2023
			Fair value changes/Accrued Interest	Current / Non - current classification	
Borrowings- Non Current	593.13	(382.02)	-	57.48	268.59
Borrowings- Current	4,617.98	318.40	10.92	(57.48)	4,889.82
Total	5,211.11	(63.62)	10.92	-	5,158.41

R R KABEL LIMITED
Annexure III - Restated Consolidated Statement of Cash Flows

(₹ in millions)

Particulars	As at 31 March 2021	Cash Flow	Non Cash Changes		As at 31 March 2022
			Fair value changes/Accrued Interest	Current / Non - current classification	
Borrowings- Non Current	712.82	262.22	-	(381.91)	593.13
Borrowings- Current	4,274.31	(38.51)	0.27	381.91	4,617.98
Total	4,987.13	223.71	0.27	-	5,211.11

(₹ in millions)

Particulars	As at 31 March 2020	Cash Flow	Non Cash Changes		As at 31 March 2021
			Fair value changes/Accrued Interest	Current / Non - current classification	
Borrowings- Non Current	682.82	198.68	-	(168.68)	712.82
Borrowings- Current	3,270.08	863.07	(27.52)	168.68	4,274.31
Total	3,952.90	1,061.75	(27.52)	-	4,987.13

The above statement should be read with Material Accounting Policies forming part of the Restated Consolidated Financial Information in Annexure V, Notes to Restated Consolidated Financial Information in Annexure VI and Statement of Adjustments to Restated Consolidated Financial Information in Annexure VII.

As per our Report of even date
For B S R & Co. LLP
Chartered Accountants
 Firm Registration No: 101248W/W-100022

For and on behalf of the Board of Directors of
R R Kabel Limited
 CIN: U28997MH1995PLC085294

Rupen Shah
Partner
 Membership No. 116240

Tribhuvanprasad Rameshwarlal Kabra
Executive Chairman
 DIN : 00091375

Shreegopal Rameshwarlal Kabra
Managing Director
 DIN : 00140598

Place: Ahmedabad
 Date: 30 August 2023

Dinesh Aggarwal
Chief Executive Officer

Himanshu Navinchandra Parmar
Company Secretary
 Membership No.FCS 10118

Rajesh Babu Jain
Chief Financial Officer
 Membership No. 20811

Place: Mumbai
 Date: 30 August 2023

R R KABEL LIMITED
Annexure IV - Restated Consolidated Statement of Changes in Equity
(A) EQUITY SHARE CAPITAL

Particulars	As at 30 June 2023		As at 30 June 2022		As at 31 March 2023		As at 31 March 2022		As at 31 March 2021	
	No. of Shares	(₹ in millions)	No. of Shares	(₹ in millions)	No. of Shares	(₹ in millions)	No. of Shares	(₹ in millions)	No. of Shares	(₹ in millions)
Balance as at beginning of the reporting period/year	9,56,96,296	478.48	2,39,24,074	239.24	2,39,24,074	239.24	2,39,24,074	239.24	2,33,95,276	233.95
Changes in share capital (Note 50)	-	-	-	-	-	-	-	-	5,28,798	5.29
Add:- shares split during the year (Note 11.9)	-	-	-	-	2,39,24,074	-	-	-	-	-
Add:- Bonus shares Issued during the year (Note 11.9)	-	-	-	-	4,78,48,148	239.24	-	-	-	-
Balance as at end of the reporting period / year	9,56,96,296	478.48	2,39,24,074	239.24	9,56,96,296	478.48	2,39,24,074	239.24	2,39,24,074	239.24

(B) INSTRUMENT ENTIRELY EQUITY IN NATURE

Particulars	As at 30 June 2023		As at 30 June 2022		As at 31 March 2023		As at 31 March 2022		As at 31 March 2021	
	No. of Shares	(₹ in millions)	No. of Shares	(₹ in millions)	No. of Shares	(₹ in millions)	No. of Shares	(₹ in millions)	No. of Shares	(₹ in millions)
Balance as at beginning of the reporting period/year	38,43,140	4,151.86	38,43,140	4,151.86	38,43,140	4,151.86	38,43,140	4,151.86	37,02,572	4,000.00
Changes in instrument entirely equity in nature (Note 50)	-	-	-	-	-	-	-	-	1,40,568	151.86
Balance as at end of the reporting period / year	38,43,140	4,151.86	38,43,140	4,151.86	38,43,140	4,151.86	38,43,140	4,151.86	38,43,140	4,151.86

(C) OTHER EQUITY

For the three-month periods ended 30 June 2023 and 30 June 2022

Particulars	Reserves and surplus				Other Comprehensive income		Share Suspense Account (refer note f)	Total Other Equity
	Capital Redemption Reserve (refer note a)	Capital Reserve (refer note b)	Retained Earnings	Share based payment reserve outstanding (refer note c)	Equity Instruments through Other Comprehensive income (refer note d)	Foreign Currency Translation Reserve (refer note e)		
Balance as at 1 April 2022 (A)	7.51	125.05	7,672.98	7.52	267.21	31.66	-	8,111.93
Profit for the year	-	-	181.42	-	-	-	-	181.42
Pursuant to acquisition of business (Note 51)	-	167.16	-	-	-	-	-	167.16
Other comprehensive income/(loss)	-	-	(1.35)	-	(42.57)	-	-	(43.92)
Employee stock option (Note 48)	-	-	-	2.86	-	-	-	2.86
Exchange difference arising on translation of foreign operation	-	-	-	-	-	(8.37)	-	(8.37)
(B)	-	167.16	180.07	2.86	(42.57)	(8.37)	-	299.15
Balance as at 30 June 2022 (C) = (A+B)	7.51	292.21	7,853.05	10.38	224.64	23.29	-	8,411.08

Particulars	Reserves and surplus				Other Comprehensive income		Share Suspense Account (refer note f)	Total Other Equity
	Capital Redemption Reserve (refer note a)	Capital Reserve (refer note b)	Retained Earnings	Share based payment reserve outstanding (refer note c)	Equity Instruments through Other Comprehensive income (refer note d)	Foreign Currency Translation Reserve (refer note e)		
Balance as at 1 April 2023 (A)	-	292.21	8,836.76	12.56	422.93	2.15	-	9,566.61
Profit for the year	-	-	743.48	-	-	-	-	743.48
Other comprehensive income/(loss)	-	-	(0.85)	-	298.89	-	-	298.04
Exchange difference arising on translation of foreign operation	-	-	-	-	-	(2.57)	-	(2.57)
Employee stock option (Note 48)	-	-	-	3.18	-	-	-	3.18
(B)	-	-	742.63	3.18	298.89	(2.57)	-	1,042.13
Balance as at 30 June 2023 (C) = (A+B)	-	292.21	9,579.39	15.74	721.82	(0.42)	-	10,608.74

R R KABEL LIMITED
Annexure IV - Restated Consolidated Statement of Changes in Equity

For the years ended 31 March 2023, 31 March 2022 and 31 March 2021

(₹ in millions)

Particulars	Reserves and surplus				Other Comprehensive income		Share Suspense Account (refer note f)	Total Other Equity
	Capital Redemption Reserve (refer note a)	Capital Reserve (refer note b)	Retained Earnings	Share based payment reserve outstanding (refer note c)	Equity Instruments through Other Comprehensive income (refer note d)	Foreign Currency Translation Reserve (refer note e)		
Balance as at 1 April 2020 (A)	7.51	125.05	4,459.69	-	23.70	33.40	157.15	4,806.50
Profit for the year	-	-	1,353.98	-	-	-	-	1,353.98
Other comprehensive income/(loss)	-	-	3.02	-	73.56	-	-	76.58
Exchange difference arising on translation of foreign operation	-	-	-	-	-	(4.70)	-	(4.70)
(B)	-	-	1,357.00	-	73.56	(4.70)	-	1,425.86
Share issued in pursuant to scheme of amalgamation (refer note 50)	-	-	-	-	-	-	(157.15)	(157.15)
(C)	-	-	-	-	-	-	(157.15)	(157.15)
Balance as at 31 March 2021 (D)= (A+B+C)	7.51	125.05	5,816.69	-	97.26	28.70	-	6,075.21
Profit for the year	-	-	2,139.37	-	-	-	-	2,139.37
Other comprehensive income	-	-	(5.41)	-	169.95	-	-	164.54
Exchange difference arising on translation of foreign operation	-	-	-	-	-	2.96	-	2.96
(E)	-	-	2,133.96	-	169.95	2.96	-	2,306.87
Dividends	-	-	(277.67)	-	-	-	-	(277.67)
Employee stock option (Note 48)	-	-	-	7.52	-	-	-	7.52
(F)	-	-	(277.67)	7.52	-	-	-	(270.15)
Balance as at 31 March 2022 (G)= (D+E+F)	7.51	125.05	7,672.98	7.52	267.21	31.66	-	8,111.93
Profit for the year	-	-	1,898.72	-	-	-	-	1,898.72
Pursuant to acquisition of business (Note 51)	-	167.16	-	-	-	-	-	167.16
Other comprehensive income/(loss)	-	-	(3.40)	-	155.72	-	-	152.32
Exchange difference arising on translation of foreign operation	-	-	-	-	-	(29.51)	-	(29.51)
Employee stock option (Note 48)	-	-	-	5.04	-	-	-	5.04
(H)	-	167.16	1,895.32	5.04	155.72	(29.51)	-	2,193.73
Dividends	-	-	(499.81)	-	-	-	-	(499.81)
Issue of Bonus Shares (Note 11.9)	(7.51)	-	(231.73)	-	-	-	-	(239.24)
(I)	(7.51)	-	(731.54)	-	-	-	-	(739.05)
Balance as at 31 March 2023 (J)= (G+H+I)	-	292.21	8,836.76	12.56	422.93	2.15	-	9,566.61

The above statement should be read with Material Accounting Policies forming part of the Restated Consolidated Financial Information in Annexure V, Notes to Restated Consolidated Financial Information in Annexure VI and Statement of Adjustments to Restated Consolidated Financial Information in Annexure VII.

Note :
(a) Capital redemption reserve

Capital redemption reserve was created to the extent of share capital extinguished and it was used during the year end 31 March 2023 for issue of bonus shares.

(b) Capital reserve

Capital reserve of ₹ 125.05 million was created pursuant to scheme of amalgamation during the year ended 31 March 2020 and ₹ 167.16 million was created pursuant to business acquisition during the year ended by 31 March 2023.

R R KABEL LIMITED**Annexure IV - Restated Consolidated Statement of Changes in Equity****(c) Share based payment reserve outstanding**

Share based payment reserve outstanding represents recognition of fair value of equity-settled share based option plan. Fair value of equity- settled share based payment transactions with employees is recognized in Restated Consolidated Statement of Profit and Loss with corresponding credit to share based payment reserve. The Company has two stock option schemes under which options to subscribe for the Company's shares have been granted to certain employees. The share based payment reserve is used to recognise the value of equity- settled share- based payments provided to employees, including key management personnel, as part of their remuneration.

(d) Equity instruments through other comprehensive income

This represents the cumulative gains/(losses) arising on the revaluation of equity instruments measured at fair value through other comprehensive income, under an irrevocable option, it will be reclassified to retained earnings when such assets are disposed off.

(e) Foreign currency translation reserve

Foreign currency translation reserve comprises of exchange differences arising from translation of financial statements of foreign Joint venture.

(f) Share suspense account

Share suspense account includes ₹ 5.29 million towards equity shares suspense account and ₹ 151.86 million towards compulsory convertible preference share suspense account created pursuant to scheme of amalgamation. During the year ended 31 March 2021 the Company has issued 5,28,798 fully paid up equity shares of ₹ 10 each and 1,40,568 Compulsory Convertible Preference Shares (CCPS) of ₹ 1,080.33 each pursuant to scheme of amalgamation (refer Note 50).

As per our Report of even date
For B S R & Co. LLP
Chartered Accountants
Firm Registration No: 101248W/W-100022

For and on behalf of the Board of Directors of
R R Kabel Limited
CIN: U28997MH1995PLC085294

Rupen Shah
Partner
Membership No. 116240

Tribhuvanprasad Rameshwari Lal Kabra
Executive Chairman
DIN : 00091375

Shreegopal Rameshwari Lal Kabra
Managing Director
DIN : 00140598

Place: Ahmedabad
Date: 30 August 2023

Dinesh Aggarwal
Chief Executive Officer

Himanshu Navinchandra Parmar
Company Secretary
Membership No.FCS 10118

Rajesh Babu Jain
Chief Financial Officer
Membership No. 20811

Place: Mumbai
Date: 30 August 2023

CORPORATE INFORMATION

The Restated Consolidated Financial Information comprises of Consolidated Financial Statements of R R Kabel Limited (the Company) and its joint venture RR-Imperial Electricals Limited for the three- month periods ended 30 June 2023, 30 June 2022 and the years ended 31 March 2023, 31 March 2022, and 31 March 2021. “Period” hereinafter refers to three-month period starting from 1 April to 30 June unless otherwise specifically mentioned.

The Company is mainly into the manufacturing of PVC insulated wires and cables, power cables and special cables. The Company has five manufacturing sites in India. The first unit is situated in the UT of Dadra and Nagar Haveli, second unit is situated at Waghodia in the State of Gujarat, third unit of Fast-Moving Electrical Goods [FMEG] at Roorkee in the state of Uttarakhand, fourth unit of FMEG at Bengaluru in the state of Karnataka, fifth unit of FMEG at Gagret in the state of Himachal Pradesh. The Company has strategically located its sales offices and depots pan India.

The Joint venture is engaged in the business of manufacturing of enamelled winding wires, strips, PVC Insulated wires and cables.

The Restated Consolidated Financial Information for the three-month periods ended 30 June 2023, 30 June 2022 and the years ended 31 March 2023, 31 March 2022, and 31 March 2021 were approved by the Board of Directors and authorized for issue on 30 August 2023.

The functional and presentation currency of the Company is Indian Rupees (₹) in millions which is the currency of the primary economic environment in which the Company operates.

1. MATERIAL ACCOUNTING POLICIES**(A) BASIS OF PREPARATION OF RESTATED CONSOLIDATED FINANCIAL STATEMENTS****(i) Statement of compliance**

The Company has prepared its Restated Consolidated Financial Information to comply with the accounting standards specified under section 133 of the Companies Act, 2013 read with Companies (Indian Accounting Standards) Rules, 2015, as amended from time to time.

The Restated Consolidated Financial Information of the Company comprise of the Restated Consolidated Statement of Assets and Liabilities as at 30 June 2023, 30 June 2022, 31 March 2023, 31 March 2022 and 31 March 2021, the Restated Consolidated Statement of Profit and Loss (including Other Comprehensive Income), Restated Consolidated Statement of Changes in Equity and the Restated Consolidated Statement of Cash Flows for the three month periods ended 30 June 2023, 30 June 2022 and years ended 31 March 2023, 31 March 2022 and 31 March 2021, the summary of material accounting policies and explanatory notes (collectively, the Restated Consolidated Financial Information’).

These Restated Consolidated Financial Information have been prepared by the management as required under the Securities and Exchange Board of India (Issue of Capital and Disclosure Requirements) Regulations, 2018, as amended (“ICDR Regulations”) issued by the Securities and Exchange Board of India (“SEBI”), in pursuance of the Securities and Exchange Board of India Act, 1992, for the purpose of inclusion in the Red Herring Prospectus (“RHP”) in connection with the proposed initial public offering of equity shares of face value of ₹ 5 each of the Company comprising a fresh issue of equity shares and an offer for sale of equity shares held by the selling shareholders (the “Offer”), prepared by the Company in terms of the requirements of:

- a. Section 26 of Part I of Chapter III of the Companies Act, 2013 (“the Act”);
- b. The Securities and Exchange Board of India (Issue of Capital and Disclosure Requirements) Regulations, 2018 as amended and
- c. The Guidance Note on Reports in Company Prospectuses (Revised 2019) issued by the Institute of Chartered Accountants of India (ICAI) (the “Guidance Note”).

The Restated Consolidated Financial information of the Company has been prepared to comply in all material respects with the Indian Accounting Standards (“Ind AS”) as prescribed under Section 133 of the Act read with the Companies (Indian Accounting Standards) Rules, 2015 (as amended from time to time), presentation requirements of Division II of Schedule III to the Companies Act, 2013, as applicable to the Consolidated Financial Statements and other relevant provisions of the Act.

The Restated Consolidated Financial Information has been compiled by the Company from:

- Audited Interim Consolidated Financial Statements of the Company and its joint venture as at and for the three-month periods ended 30 June 2023 and 30 June 2022 prepared in accordance with Indian Accounting Standard (Ind AS) 34 “Interim Financial Reporting”, specified under section 133 of the Act and other accounting principles generally accepted in India.
- Audited Consolidated Financial Statements of the Company and its joint venture as at and for the years ended 31 March 2023, 31 March 2022 and 31 March 2021, prepared in accordance with the Indian Accounting Standards (referred to as “Ind AS”) as prescribed under Section 133 of the Act read with Companies (Indian Accounting Standards) Rules 2015, as amended, and other accounting principles generally accepted in India.

The accounting policies set out below have been applied consistently to the periods presented in the Restated Consolidated Financial Information.

The Restated Consolidated Financial Information is presented in Indian Rupees (₹) millions, except where otherwise indicated.

(ii) Basis of Measurement:

The Restated Consolidated Financial Information has been prepared on a going concern basis, accrual basis and a historical cost basis except for the following financial assets and liabilities which have been measured at fair value at the end of each reporting period:

- (a) Derivative financial instruments
- (b) Certain financial assets and liabilities (Refer note 37 for accounting policy regarding financial instruments)
- (c) Net defined benefit plan

Current/ Non- Current Classification

Any asset or liability is classified as current if it satisfies any of the following conditions:

- the asset/liability is expected to be realized/settled in the Company's normal operating cycle;
- the asset is intended for sale or consumption;
- the asset/liability is held primarily for the purpose of trading;
- the asset/liability is expected to be realized/settled within twelve months after the reporting period;
- the asset is cash or cash equivalent unless it is restricted from being exchanged or used to settle a liability for at least twelve months after the reporting date;
- in the case of a liability, the Company does not have an unconditional right to defer settlement of the liability for at least twelve months after the reporting date.
- All other assets and liabilities are classified as non-current.

For the purpose of current/non-current classification of assets and liabilities, the Company has ascertained its normal operating cycle as twelve months. This is based on the nature of product and the time between the acquisition of assets or inventories for processing and their realization in cash and cash equivalents.

(iii) Functional and Presentation Currency

Items included in the Restated Consolidated Financial Information of the Company are measured using the currency of the primary economic environment in which the Company operates ('the functional currency'). The functional and presentation currency of the Company is Indian Rupees (₹) in Millions.

(B) Use of estimates and judgements

The preparation of Restated Consolidated Financial Information, in conformity with Ind AS requires management to make judgements, estimates and assumptions that affect the application of accounting policies and the reported amounts of assets, liabilities, income and expenses. The management bases its estimates on historical experience and various other assumptions that are believed to be reasonable under the circumstances. Actual results may differ from those estimates.

The Estimates and underlying assumptions are reviewed on an ongoing basis. Revisions to accounting estimates are recognised in the period in which the estimates are revised, and future periods are affected.

The key assumptions concerning the future and other key sources of estimation uncertainty at the reporting date, that have a significant risk of causing a material adjustment to the carrying amounts of assets and liabilities within the next financial year, are described below. The Company based its assumptions and estimates on parameters available when the Restated Consolidated Financial Information were prepared. Existing circumstances and assumptions about future developments, however, may change due to market changes or circumstances arising that are beyond the control of the Company. Such changes are reflected in the assumptions when they occur. The Company uses the following critical accounting estimates in preparation of its Restated Consolidated Financial Information:

(i) Useful lives of property, plant and equipment

The Company depreciates property, plant and equipment on a straight-line basis over estimated useful lives of the assets which is derived based on an estimate of an asset's expected useful life and the expected residual value at the end of its life. The lives are based on historical experience with similar assets as well as anticipation of future events, which may impact their life, such as changes in technology. The estimated useful life is reviewed at least annually.

(ii) Impairment of investments in joint- ventures

Determining whether the investment in joint ventures is impaired requires an estimate in the value in use of investments. The Company reviews its carrying value of investment carried at cost (net of impairment, if any) annually, or more frequently when there is indication for impairment. If the recoverable amount is less than its carrying amount, the impairment loss is accounted for in the Restated Consolidated Statement of Profit and Loss. In considering the value in use, the Board of Directors have anticipated the future market conditions and other parameters that affect the operations of these entities.

(iii) Provision

The Company estimates the provisions that have present obligations as a result of past events, and it is probable that out-flow of resources will be required to settle the obligations. These provisions are reviewed at the end of each reporting period and are adjusted to reflect the current best estimates. The timing of recognition requires application of judgement to existing facts and circumstances which may be subject to change.

(iv) Contingencies

In the normal course of business, contingent liabilities may arise from litigation and other claims against the Company. Potential liabilities that are possible but not probable of crystallizing or are very difficult to quantify reliably are treated as contingent liabilities. Such liabilities are disclosed in the notes but are not recognized. Contingent assets are neither recognized nor disclosed in the Restated Consolidated Financial Information.

(v) Fair value measurement of financial instruments

When the fair values of financial assets and financial liabilities recorded in the Restated Consolidated Statement of Assets and Liabilities cannot be measured based on quoted prices in active markets, the fair value is measured using appropriate valuation techniques. The inputs to these models are taken from observable markets where possible, but where this is not feasible, a degree of judgement is required in establishing fair values. Judgements include considerations of inputs such as liquidity risk, credit risk and volatility. Changes in assumptions about these factors could affect the reported fair value of financial instruments.

(Refer note 37 for accounting policy on Fair value measurement of financial instruments).

(vi) Provision for income tax and deferred tax assets

The Company uses estimates and judgements based on the relevant rulings in the areas of allocation of revenue, costs, allowances and disallowances which is exercised while determining the provision for income tax. A deferred tax asset is recognised to the extent that it is probable that future taxable profit will be available against which the deductible temporary differences and tax losses can be utilised. Deferred tax assets are recognised for unused tax losses to the extent that it is probable that taxable profit will be available against which the losses can be utilised. Significant management judgement is required to determine the amount of deferred tax assets that can be recognised, based upon the likely timing and the level of future taxable profits together with future tax planning strategies. Accordingly, the Company exercises its judgement to reassess the carrying amount of deferred tax assets at the end of each reporting period.

(vii) Employee benefits

The accounting of employee benefits in the nature of defined employee benefit plan requires the Company to use assumptions. These assumptions have been explained under employee benefits note 35.

(viii) Leases

The Company evaluates if an arrangement qualifies to be a lease as per the requirements of Ind AS 116. Identification of a lease requires significant judgment. The Company uses significant judgement in assessing the lease term (including anticipated renewals) and the applicable discount rate. The Company determines the lease term as the non-cancellable period of a lease, together with both periods covered by an option to extend the lease if the Company is reasonably certain to exercise that option; and periods covered by an option to terminate the lease if the Company is reasonably certain not to exercise that option. In assessing whether the Company is reasonably certain to exercise an option to extend a lease, or not to exercise an option to terminate a lease, it considers all relevant facts and circumstances that create an economic incentive for the Company to exercise the option to extend the lease, or not to exercise the option to terminate the lease. The Company revises the lease term if there is a change in the non-cancellable period of a lease.

The discount rate is generally based on the incremental borrowing rate specific to the lease being evaluated or for a portfolio of leases with similar characteristics.

(ix) Measurement of ECL allowance for trade receivables

Refer accounting policy for impairment of financial assets for measurement of ECL allowance on trade receivables under section C (v) below.

(x) Impairment of financial and non-financial assets

Refer accounting policy C (v) provided below for impairment of assets.

(xi) Basis of consolidation of Joint Venture

The Restated Consolidated Financial Information comprise the Financial Statements of the Company and its joint venture for the nine-month period ended 30 June 2023, 30 June 2022 and years ended 31 March 2023, 31 March 2022 and 31 March 2021.

The joint venture is an arrangement in which two or more parties have joint control. Joint control is the contractually agreed sharing of control of an arrangement, which exists only when decision about the relevant activities require the unanimous consent of the parties sharing control.

The Company's investment in joint venture is accounted for using the equity method. Under the equity method, the investment in a joint venture is initially recognised at cost. The carrying amount of the investment is adjusted to recognise changes in the Company's share of net assets of the joint arrangement since the acquisition date. Goodwill, if any relating to the joint venture is included in the carrying amount of the investment and is not tested for impairment individually.

The Restated Consolidated Statement of Profit and Loss reflects the Company's share of the results of jointly controlled entity. Any change in OCI of the jointly controlled entity is presented as part of the Company's OCI. Unrealised gains and losses resulting from inter-Company transactions between the Company and the joint venture are eliminated to the extent of the interest in the joint venture.

If the Company's share of losses of a joint venture exceeds its interest in that joint venture, the Company discontinues recognising its share of further losses. Additional losses are recognised only to the extent that the Company has incurred legal or constructive obligations or made payments on behalf of the joint venture. If the joint venture subsequently reports profits, the Company resumes recognising its share of those profits only after its share of the profits equals the share of losses not recognized.

After application of the equity method, the Company determines whether it is necessary to recognise an impairment loss on its investment in its joint venture. At each reporting date, the Company determines whether there is objective evidence that the investment in the joint venture is impaired. If there is such evidence, the Company calculates the amount of impairment as the difference between the recoverable amount of the joint venture and its carrying value, and then recognises the loss as share of profit of a joint venture in the consolidated statement of profit or loss.

(C) **Other Material accounting policies**

(i) **Revenue**

Revenue from contracts with customers is recognised when control of the goods and services are transferred to the customer at an amount that reflects the consideration to which the Company expects to be entitled in exchange for those goods or services. The Company assesses promises in the contract that are separate performance obligations to which a portion of transaction price is allocated.

Revenue is measured based on the transaction price as specified in the contract with the customer. It excludes taxes or other amounts collected from customers in its capacity as an agent. In determining the transaction price, the Company considers below, if any:

Variable Consideration: This includes trade discounts, rebates and returns. It is estimated at contract inception and constrained until it is highly probable that a significant revenue reversal in the amount of cumulative revenue recognised will not occur when the associated uncertainty with the variable consideration is subsequently resolved. It is reassessed at end of each reporting period.

Consideration payable to a customer: Such Amounts are accounted as reduction of transaction price and therefore, of revenue unless the payment to the customer is in exchange for a distinct good or service that the customer transfers to the Company.

Trade Receivable: A receivable represents the Company's right to an amount of consideration that is unconditional i.e., only the passage of time is required before payment of consideration is due.

(ii) **Property, Plant and Equipment**

An item of property, plant and equipment is recognised as an asset if it is probable that the future economic benefits associated with the item will flow to the Company and its cost can be measured reliably. This recognition principle is applied to the costs incurred initially to acquire an item of property, plant and equipment and also to the costs incurred subsequently to add to, replace part of, or service it. All other repair and maintenance costs, including regular servicing, are recognised in the statement of profit and loss as incurred. When a replacement occurs, the carrying value of the replaced part is de-recognised. Where an item of property, plant and equipment comprises major components having different useful lives, these components are accounted for as separate items.

Freehold land is carried at historical cost. All other items of property, plant and equipment are stated at acquisition cost net of accumulated depreciation and accumulated impairment losses, if any. The cost of an item of property, plant and equipment comprises of its purchase price including import duties and other non-refundable purchase taxes or levies, directly attributable cost of bringing the asset to its working condition for its intended use and the initial estimate of decommissioning, restoration and similar liabilities, if any. Any trade discount or rebate is deducted in arriving at the purchase price. Cost includes cost of replacing a part of a plant and equipment if the recognition criteria are met.

Items such as spare parts, stand-by equipment and servicing equipment that meet the definition of property, plant and equipment are capitalized at cost and depreciated over their useful life.

Capital work-in-progress includes cost of property, plant and equipment not ready for the intended use as at the end of the period/year. Advances paid towards the acquisition of property, plant and equipment outstanding at each Restated Consolidated Statement of Assets and Liabilities date is classified as 'capital advances' under other non-current assets.

The cost and related accumulated depreciation are eliminated from the Restated Consolidated Financial Information upon sale or retirement of the property, plant and equipment and the resultant gains or losses are recognised in the statement of profit and loss. Property, plant and equipment to be disposed of is reported at the lower of the carrying value or the fair value less cost of sale.

(iii) **Other Intangible Assets**

Other Intangible assets acquired are initially measured at cost. Other intangible assets arising on acquisition of business are measured at fair value as at date of acquisition. Following initial recognition, other intangible assets with defined useful lives are carried at cost less accumulated amortization and accumulated impairment loss, if any. Internally generated intangibles are not capitalized, and the related expenditure is reflected in Restated Consolidated Statement of profit and loss in the period in which the expenditure is incurred.

Computer Software, an intangible asset, is measured on initial recognition at cost. Costs comprise of license fees and cost of system integration services and development.

The carrying amount of an intangible asset is derecognized on disposal or when no future economic benefits are expected from its use or disposal. On de-recognition the intangible asset is measured as the difference between the net disposal proceeds and the carrying amount of the intangible asset and is recognized in the Restated consolidated statement of profit and loss.

(iv) Depreciation on property, plant and equipment and amortisation of other intangible Assets

Depreciation on property, plant and equipment is calculated in the Restated Consolidated Statement of Profit and Loss on a straight-line method using the management assessed useful lives of the assets which is in line with the manner prescribed in Schedule II to the Companies Act, 2013.

Other Intangible Assets with finite lives are amortized on a straight-line basis over the estimated useful economic life. The amortization expense on other intangible assets with finite lives is recognized in the statement of profit and loss.

The estimated useful lives and residual values are reviewed at the end of each financial year. If any of these expectations differ from previous estimates, such change is accounted for as a change in an accounting estimate and adjusted prospectively, if any.

The estimated useful life of items of property, plant and equipment and other intangible assets are:

Particulars	Years	Particulars	Years
Factory Buildings	30	Office and Other Equipment	5 to 10
Workers Quarters	60	Vehicles	8 to 10
Plant and Equipment	15	Electrical Installations	10
Furniture and Fixtures	10	Computer Software	5
Brand	5	Royalty	2
Designs	2-3	Non-compete clause	2

(v) Impairment of assets

Impairment of financial assets

The Company applies loss allowance using the expected credit loss (ECL) model for the financial assets which are measured at amortised cost. Loss allowance for trade receivables with no significant financing component is measured at an amount equal to lifetime ECL.

Lifetime expected credit losses are the expected credit losses that result from all possible default events over the expected life of a financial instrument.

For all other financial assets, ECLs are measured at an amount equal to 12-month ECL, unless there has been a significant increase in credit risk for initial recognition in which case those are measured at lifetime ECL.

12-month expected credit losses are the portion of expected credit losses that result from default events that are possible within 12 months after the reporting date (or a shorter period if the expected life of the instrument is less than 12 months)

Impairment of non-financial assets

At each reporting date, the Company reviews the carrying values of its non-financial assets (other than inventories and deferred tax assets) to determine whether there is any indication that the carrying value of those assets may not be recoverable through continuing use. If any such indication exists, the recoverable amount of the asset is estimated in order to determine the extent of impairment loss (if any).

For impairment testing, assets are grouped together into the smallest group of assets that generates cash inflows from continuing use that are largely independent of the cash inflows of other assets or Cash Generating Units (CGU).

The recoverable amount of an individual asset or CGU is the greater of its value in use and its fair value less costs of disposal. Value in use is based on the estimated future cash flows, discounted to their present value using a pre-tax discount rate that reflects current market assessments of the time value of money and the risks specific to the asset or CGU.

An impairment loss is recognised if the carrying amount of an asset or CGU exceeds its recoverable amount.

A previously recognised impairment loss is further provided or reversed depending on changes in the circumstances and to the extent that carrying amount of the assets does not exceed the carrying amount that would have been determined if no impairment loss had previously been recognised.

(vi) Leases

The Company as a lessee

The Company's lease asset classes primarily consist of leases for land and buildings. The Company assesses whether a contract contains a lease, at inception of a contract. A contract is, or contains, a lease if the contract conveys the right to control the use of an identified asset for a period of time in exchange for consideration. To assess whether a contract conveys the right to control the use of an identified asset, the Company assesses whether: (i) the contract involves the use of an identified asset (ii) the Company has substantially all of the economic benefits from use of the asset through the period of the lease and (iii) the Company has the right to direct the use of the asset.

At the date of commencement of the lease, the Company recognizes a right-of-use asset ("ROU") and a corresponding lease liability for all lease arrangements in which it is a lessee, except for leases with a term of twelve months or less (short-term leases), variable lease and low value leases. For these short-term, variable lease and low value leases, the Company recognizes the lease payments as an operating expense on a straight-line basis over the term of the lease.

Certain lease arrangements include the options to extend or terminate the lease before the end of the lease term. ROU assets and lease liabilities includes these options when it is reasonably certain that they will be exercised.

The right-of-use assets are initially recognized at cost, which comprises the initial amount of the lease liability adjusted for any lease payments made at or prior to the commencement date of the lease plus any initial direct costs less any lease incentives. They are subsequently measured at cost less accumulated depreciation and impairment losses.

Right-of-use assets are depreciated from the commencement date on a straight-line basis over the shorter of the lease term and useful life of the underlying asset. Right of use assets are evaluated for recoverability whenever events or changes in circumstances indicate that their carrying value may not be recoverable. For the purpose of impairment testing, the recoverable amount (i.e. the higher of the fair value less cost to sell and the value-in-use) is determined on an individual asset basis unless the asset does not generate cash flows that are largely independent of those from other assets. In such cases, the recoverable amount is determined for the Cash Generating Unit (CGU) to which the asset belongs.

The lease liability is initially measured at amortized cost at the present value of the future lease payments. The lease payments are discounted using the interest rate implicit in the lease or, if not readily determinable, using the incremental borrowing rates in the country of domicile of these leases. Lease liabilities are remeasured with a corresponding adjustment to the related right of use asset if the Company changes its assessment if whether it will exercise an extension or a termination option.

Lease liability and ROU asset have been separately presented in the Restated Consolidated Statement of Assets and Liabilities and lease payments have been classified as cash flows from financing activity.

The Company as a lessor

Leases for which the Company is a lessor are classified as a finance or operating lease. Whenever the terms of the lease transfer substantially all the risks and rewards of ownership to the lessee, the contract is classified as a finance lease. All other leases are classified as operating leases. For operating leases, rental income is recognized on a straight-line basis over the term of the relevant lease.

(vii) Investments

Investments in mutual funds are primarily held for the Company's temporary cash requirements and can be readily convertible in cash. These investments are initially recorded at fair value and classified as fair value through profit or loss.

Refer to the financial instruments accounting policy ix for methods of valuation.

(viii) Inventories:

Raw Materials, Work-in-progress, Stock in trade and Finished goods are valued at the lower of cost or net realizable value. The cost is determined using First in first out (FIFO) method.

The cost of Inventories comprises the cost of purchases, the cost of conversion and the cost of packing materials in case of Finished Goods.

The cost of purchase comprises of the purchase price including duties and taxes (other than those subsequently recoverable by the Company from the taxing authorities), freight inward and other expenditure directly attributable to the acquisition but net of trade discount, rebates, duties for import under advance licenses and other similar items.

The cost of conversion comprises of depreciation on factory buildings and plant and machineries, power and fuel, factory management and administration expenses, repairs and maintenance and consumable stores and spares.

Packing Materials, Consumable Stores and Spares and Fuel are valued at lower of cost or net realizable value. The cost is determined using FIFO method.

Scrap is valued at net realizable value.

(ix) Financial Instruments

A financial instrument is any contract that gives rise to a financial asset of one entity and a financial liability or equity instrument of another entity.

The Company recognizes financial assets and financial liabilities when it becomes a party to the contractual provisions of the instrument. All financial assets and liabilities are recognized at fair value on initial recognition, except for trade receivables which are initially measured at transaction price. Transaction costs that are directly attributable to the acquisition or issue of financial assets and financial liabilities that are not at fair value through profit or loss are added to / deducted from the fair value on initial recognition.

a) **Financial Assets**

Cash and bank balances

Cash and bank balances consist of:

- **Cash and cash equivalents** - which includes cash on hand, deposits held at call with banks and other short-term deposits which are readily convertible into known amounts of cash, are subject to an insignificant risk of change in value and have original maturities of 3 months or less from the date of such deposits. These balances with banks are unrestricted for withdrawal and usage.
- **Other bank balances** - which includes balances and deposits with banks that are restricted for withdrawal and usage.

Financial assets carried at amortised cost

A financial asset are subsequently measured at amortised cost if it is held within a business model whose objective is to hold the asset in order to collect contractual cash flows and the contractual terms of the financial asset give rise on specified dates to cash flows that are solely payments of principal and interest on the principal amount outstanding, using the Effective Interest Rate (EIR) method less impairment, if any, the amortisation of EIR and loss arising from impairment, if any is recognised in the consolidated statement of profit and loss.

Financial assets measured at fair value

A financial asset is measured at fair value through other comprehensive income if it is held within a business model whose objective is to hold these assets in order to collect contractual cash flows or to sell these financial assets and the contractual terms of the financial assets give rise on specified dates to cash flows that are solely payments of principal and interest on the principal amount outstanding. Fair value movements are recognised in the other comprehensive income.

The Company and the joint venture in respect of equity instruments (other than equity instruments of joint venture) which are not held for trading has made an irrevocable election to present the subsequent changes in fair value of such equity instruments in other comprehensive income. Such an election is made by the Company on an instrument-by-instrument basis at the time of initial recognition of such equity investments. On de-recognition, cumulative gain or loss previously recognised in other comprehensive income is reclassified from the equity to retained earnings in the statement of changes in equity.

A financial asset not classified as either amortised cost or at fair value through other comprehensive income is carried at fair value through the consolidated statement of profit and loss.

De-recognition of Financial Assets

A financial asset is de-recognised only when

- The contractual rights to cash flows from the financial asset expires
- The Company has transferred the contractual rights to receive cash flows from the financial asset or
- Retains the contractual rights to receive the cash flows of the financial asset but assumes a contractual obligation to pay the cash flows to one or more recipients.

Where the Company and the joint venture has transferred an asset, the Company and the Joint venture evaluates whether it has transferred substantially all risks and rewards of ownership of the financial asset. In such cases, the financial asset is de-recognised. Where the entity has not transferred substantially all risks and rewards of ownership of the financial asset, the financial asset is not de-recognised.

Where the entity has neither transferred a financial asset nor retains substantially all risks and rewards of ownership of the financial asset, the financial asset is de-recognised if the Company and the Joint venture has not retained control of the financial asset. Where the Company and the Joint venture retain control of the financial asset, the asset is continued to be recognised to the extent of continuing involvement in the financial asset.

b) **Financial Liabilities**

Classification as debt or equity

Financial liabilities and equity instruments issued by the Company and the joint venture are classified according to the substance of the contractual arrangements entered into and the definitions of a financial liability and an equity instrument.

Equity Instruments

An equity instrument is any contract that evidences a residual interest in the assets of the Company and the Joint venture after deducting all its liabilities. Equity instruments are recorded at the proceeds received, net of direct issue costs.

Financial Liabilities

Trade and other payables are initially measured at fair value, net of transaction costs, and are subsequently measured at amortised cost using the effective interest rate method. Financial liabilities carried at fair value through profit or losses are measured at fair value with all changes in fair value recognised in the Restated Consolidated Statement of Profit and Loss.

Interest bearing loans and overdrafts are initially measured at fair value, and are subsequently measured at amortised cost using effective interest rate method. Any difference between proceeds (net of transaction cost) and the settlement amount of borrowing is recognised over the terms of the borrowings in the Restated Consolidated Statement of Profit and Loss.

De-recognition

A financial liability is de-recognised when the obligation specified in the contract is discharged, cancelled or has expired.

c) Financial Guarantee Contracts

Financial guarantee contracts are those contracts that require specific payment to be made to reimburse the holder for a loss it incurs because the specified debtor fails to make a payment when due in accordance with the terms of a debt instrument. Financial guarantee contracts are recognised initially as a liability at fair value adjusted for transaction cost that are directly attributable to the issuance of the guarantee. Subsequently, the liability is measured at the higher of the amount of loss allowance determined as per impairment requirements of Ind AS 109 and the amount recognised less cumulative amortisation.

d) Derivative financial instruments

The Company and the Joint venture enter into derivative financial contracts in the nature of forward currency contracts with banks to reduce business risks which arise from its exposures to foreign exchange. The instruments are employed as hedges of transactions included in the Restated Consolidated Financial Information or for highly probable forecast transactions / firm contractual commitments.

Derivatives are initially accounted for and measured at fair value from the date the derivative contract is entered into and are subsequently re-measured to their fair value at the end of each reporting period. Any change therein is generally recognised in the Restated Consolidated Statement of profit and loss. Derivatives are carried as financial assets when fair value is positive and as financial liabilities when fair value is negative.

e) Offsetting Financial Instruments

Financial assets and liabilities are off-set and the net amount is reported in the Restated Consolidated Financial Information where there is a legally enforceable right to offset the recognised amounts and there is an intention to settle on a net basis or realise the asset and settle the liability simultaneously. The legally enforceable right must not be contingent on future events and must be enforceable in the normal course of business and in the event of default, insolvency or bankruptcy of the Company and the joint venture or the counterparty.

(x) Fair Value Measurement

The Company measures financial instruments at fair value in accordance with the accounting policies mentioned above. Fair value is the price that would be received to sell an asset or paid to transfer a liability in an orderly transaction between market participants at the measurement date. The fair value measurement is based on the presumption that the transaction to sell the asset or transfer the liability takes place either in the principal market for asset or liability or in the absence of a principal market, in the most advantageous market for the asset or liability.

All assets and liabilities for which fair value is measured or disclosed in the Restated Consolidated Financial Information are categorized within the fair value hierarchy that categorizes into three levels, described as follows:

- Level 1 — quoted (unadjusted) market prices in active markets for identical assets or liabilities
- Level 2 — inputs other than quoted prices included within Level 1 that are observable for the asset or liability, either directly or indirectly
- Level 3 — inputs that are unobservable for the asset or liability

For assets and liabilities that are recognized in the Restated Consolidated Financial Information at fair value on a recurring basis, the Company and its joint venture determines whether transfers have occurred between levels in the hierarchy by re-assessing categorization at the end of each reporting period and discloses the same.

(xi) Provisions, Contingent Liabilities and Contingent Assets

Provisions are recognised when the Company has a present legal or constructive obligation as a result of past events, it is probable that an outflow of resources will be required to settle the obligation and the amount can be reliably estimated. These are reviewed at each period/year end and reflect the best current estimate. Provisions are not recognised for future operating losses.

Where there are a number of similar obligations, the likelihood that an outflow will be required in settlement is determined by considering the class of obligations as a whole. A provision is recognised even if the likelihood of an outflow with respect to any one item included in the same class of obligations may be small.

Provisions are measured at the present value of Management's best estimate of the expenditure required to settle the present obligation at the end of the reporting period. The discount rate used to determine the present value is a pre-tax rate that reflects current market assessments of the time value of money and the risks specific to the liability. The increase in the provision due to the passage of time is recognised as interest expense.

Contingent liabilities are disclosed when there is a possible obligation arising from past events, the existence of which will be confirmed only by the occurrence or non-occurrence of one or more uncertain future events not wholly within the control of the Company and the joint venture or a present obligation that arises from past events where it is either not probable that an outflow of resources will be required to settle the obligation or a reliable estimate of the amount cannot be made.

Contingent assets are neither recognised nor disclosed in the Restated Consolidated Financial Information.

(xii) Government Grant

Government grants are recognised when there is reasonable assurance that the grant will be received, and the Company will comply with all the attached conditions. When the grant relates to revenue expense, it is recognised as income on a systematic basis over the period necessary to match it with the expenses that it is intended to compensate. Government grant related to expenditure on property, plant and equipment is included as cost of property, plant and equipment and is credited to the Restated Consolidated Statement of Profit and Loss over the useful lives of qualifying assets or credited to the Restated Consolidated Statement of Profit and Loss over the period in which the corresponding export obligation is fulfilled. Total grants availed less the amounts credited to the Restated Consolidated Statement of Profit and Loss at the reporting date is included in Restated Consolidated Statement of Assets and Liabilities as deferred income.

Export entitlements are recognized as income when right to receive credit as per the terms of the scheme is established in respect of the exports made and where there is no significant uncertainty regarding the ultimate collection of the relevant export proceeds.

(xiii) Employee Benefits**Short Term Obligations**

All employee benefits payable wholly within twelve months of rendering the service are classified as short-term employee benefits and they are recognized in the period in which the employee renders the related service. The Company recognizes the undiscounted amount of short-term employee benefits expected to be paid in exchange for services rendered as a liability (accrued expense) after deducting any amount already paid.

Post-Employment Benefits**i) Defined benefit plan**

The Company's net obligation in respect of an approved gratuity plan, which is a defined benefit plan, is calculated using the projected unit credit method and the same is carried out by qualified actuary. The current service cost and interest on the net defined benefit liability/(asset) is recognized in the Restated Consolidated Statement of Profit and Loss. Past service cost is immediately recognized in the Restated Consolidated Statement of Profit and Loss. Actuarial gains and losses net of deferred taxes arising from experience adjustment and changes in actuarial assumptions are recognized in other comprehensive income in the period in which they arise.

ii) Defined contribution plan

A Defined Contribution Plan is a plan under which the Company makes contribution to the Employee's Provident Fund and Employees State Insurance Contribution Fund administrated by the Central Government. The Company's contribution is charged to the Restated Consolidated Statement of Profit and Loss.

Other Long-Term Employee Benefits – Compensated absence and earned leave

The liability towards leave salary which is not expected to be settled wholly within 12 months after the end of the period in which the employees render the related services is recognized based on actuarial valuation carried out using the projected unit credit method.

(xiv) Borrowing Cost

Borrowing cost includes interest, amortization of ancillary costs incurred in connection with the arrangement of borrowings and exchange differences arising from foreign currency borrowings to the extent they are regarded as an adjustment to the interest cost.

Borrowing costs that are directly attributable to the acquisition or construction of an asset that necessarily takes a substantial period of time to get ready for its intended use are capitalized, if any. All other borrowing costs are expensed in the period in which they occur.

(xv) Income Taxes

Tax expenses for the period/year comprises current tax and deferred tax.

Current Tax

Current tax is the amount of income tax payable in respect of taxable profit for the period/year. Taxable profit differs from net profit as reported in the Restated Consolidated Statement of Profit and Loss because taxable profit is adjusted for items of income or expenses which are taxable or deductible in other years and also for items which are never taxable or deductible under the Income Tax Act, 1961("the IT Act").

The Company's liability for current tax is calculated using tax rates and tax laws that have been enacted by the end of reporting period.

Deferred Tax

Deferred tax is recognized on temporary differences between the carrying amounts of assets and liabilities in the Restated Consolidated Financial Information and the corresponding tax bases used in the computation of taxable profit under the I T Act.

Deferred tax liabilities are generally recognized for all taxable temporary differences. However, in case of temporary differences that arise from initial recognition of assets or liabilities in a transaction (other than business combination) that affects neither the taxable profit nor the accounting profit, deferred tax liabilities are not recognized.

Deferred tax assets are generally recognized for all deductible temporary differences to the extent it is probable that taxable profits will be available against which those deductible temporary differences can be utilized. In case of temporary differences that arise from initial recognition of assets or liabilities in a transaction (other than business combination) that affect neither the taxable profit nor the accounting profit, deferred tax assets are not recognized. The carrying value of deferred tax assets is reviewed at the end of each reporting period and reduced to the extent it is no longer probable that sufficient taxable profit will be available to allow all or part of the asset to be recovered.

Deferred tax is calculated at the tax rates that are expected to apply in the period when the liability is settled or the asset is realised based on the tax rates and tax laws that have been enacted by the end of the reporting period. The measurement of deferred tax liabilities and assets reflects the tax consequences that would follow from the manner in which the Company expects, at the end of the reporting period, to cover or settle the carrying value of its assets and liabilities.

Deferred tax assets and liabilities are offset when there is a legally enforceable right to offset current tax assets and liabilities and when the deferred tax balances relate to the same taxation authority. Current tax assets and tax liabilities are offset where the entity has a legally enforceable right to offset and intends either to settle on a net basis, or to realise the asset and settle the liability simultaneously.

Current and deferred tax is recognised in Restated Consolidated Statement of Profit and Loss, except to the extent that it relates to items recognised in Other Comprehensive Income or directly in equity. In this case, the tax is also recognised in Other Comprehensive Income or directly in equity, respectively.

(xvi) Segment Reporting

Operating segment is a component of an entity whose operating results are regularly reviewed by the Chief Operating Decision Maker (CODM) to make decision about resource to be allocated to the segment and assess its performance and accordingly information of two reportable segments (Wires and Cables and FMEG) have been disclosed.

(xvii) Employee Share Based Payment

Equity- settled share- based payments to employees are measured at the fair value of the employee stock options at the grant. The fair value determined at the grant date of the equity- settled share - based payments is amortised over the vesting period, based on the Company's estimate of equity instruments that will eventually vest, with a corresponding increase in equity. At the end of each reporting period, the Company revises its estimate of the number of equity instruments expected to vest. The impact of the revision of the original estimates, if any, is recognised in the Restated Consolidated Statement of Profit and Loss such that the cumulative expense reflects the revised estimate, with a corresponding adjustment to the Share based payment reserve outstanding.

The Company measures the cost of equity- settled transactions with employees using Black- Scholes model to determine the fair value of the liability incurred on the grant date. Estimating fair value for share- based payment transactions require determination of the most appropriate valuation model, which is dependent on the terms and conditions of the grant.

This estimate also requires determination of the most appropriate inputs to the valuation model including the expected life of the share option, volatility and dividend yield and making assumptions about them.

The dilutive effect, if any of outstanding options is reflected as additional share dilution in computation of diluted earnings per share.

The assumptions and models used for estimating fair value for share- based payment transactions are disclosed in Note 48.

(xviii) Restated Consolidated Statement of Cash Flows

Cash flows are reported using the indirect method, whereby profit for the period/year is adjusted for the effect of transactions of non - cash nature, any deferrals or accruals of past or future operating cash receipts or payments and item of income or expenses associated with investing or financing cashflows. The cash flows from operating, investing and financing activities of the Company are segregated.

Cash and cash equivalents for the purposes of Restated Consolidated Statement of Cash Flows comprise cash at bank and in hand and short- term deposits with an original maturity of three months or less to be cash and cash equivalents. Cash and cash equivalents consist of balances with banks which are unrestricted for withdrawal and usage.

For the purposes of Restated Consolidated Statement of Cash Flows, cash and cash equivalents consist of cash and short-term deposits, as defined above.

(xix) Events after Reporting date

Where events occurring after the reporting date provide evidence of conditions which existed at the end of the reporting period, the impact of such events is adjusted within the Restated Consolidated Financial Information. Otherwise, events after the reporting date of material size or nature are only disclosed.

(xx) Earnings per Share

Basic earnings per share are calculated by dividing the net profit or loss for the period attributable to equity shareholders by the weighted average number of equity share outstanding during the period.

For the purpose calculating Diluted Earnings per share, the net profit or loss for the period attributable to equity shareholders and the weighted average number of shares outstanding during the period are adjusted for the effects of all dilutive potential equity shares.

(xxi) Research and Development

Research and Development expenditure of a revenue nature is expensed out under the respective heads of account in the period/year in which it is incurred. Property, plant and equipment utilized for research and development are capitalized and depreciated in accordance with the policies stated for Property, plant and equipment and Intangible Assets.

(xxii) Other Income

Interest income from a financial asset is recognized when it is probable that the economic benefits will flow to the Company and the amount of income can be measured reliably. Interest income is accrued on a time basis, by reference to the principal outstanding and at the effective interest rate applicable, which is the rate that exactly discounts estimated future cash receipts through the expected life of the financial asset to that asset's net carrying amount on initial recognition.

Dividend income is recognized when the Company's right to receive the payment is established, it is probable that the economic benefits associated with the dividend will flow to the Company and the amount of dividend can be measured reliably.

(xxiii) Recent accounting pronouncements

Ministry of Corporate Affairs ("MCA") notifies new standard or amendments to the existing standards under Companies (Indian Accounting Standards) Rules as issued from time to time. On 30 June 2023, MCA has not notified any new standards or amendments to the existing standards applicable to the company.

Note 2 :

A) PROPERTY, PLANT AND EQUIPMENT

(₹ in millions)

Particulars	Gross carrying value				Accumulated Depreciation				Net carrying value
	As at 1 April 2023	Additions	Deletion	As at 30 June 2023	As at 1 April 2023	For the period ended 30 June 2023	Deletion	As at 30 June 2023	As at 30 June 2023
Land - Free Hold	408.64	65.11	-	473.75	-	-	-	-	473.75
Buildings	169.41	-	-	169.41	15.80	1.23	-	17.03	152.38
Factory Buildings	1,511.73	14.32	-	1,526.05	279.09	13.37	-	292.46	1,233.59
Worker's Quarters	52.68	-	-	52.68	6.51	0.23	-	6.74	45.94
Plant and Equipment	3,858.74	91.59	18.52	3,931.81	1,667.47	83.18	12.42	1,738.23	2,193.58
Electrical Installations	250.56	-	-	250.56	102.23	5.41	-	107.64	142.92
Furniture and Fixtures	150.27	1.85	-	152.12	59.04	4.33	-	63.37	88.75
Office and Other Equipment	183.39	4.76	0.15	188.00	79.83	7.88	0.15	87.56	100.44
Vehicles	206.83	0.07	2.30	204.60	94.03	5.16	1.94	97.25	107.35
Total	6,792.25	177.70	20.97	6,948.98	2,304.00	120.79	14.51	2,410.28	4,538.70
B) Capital Work - in - Progress	435.78	162.50	100.88	497.40	-	-	-	-	497.40

(a) For Capital-work-in progress(CWIP), following is the ageing schedule as on 30 June 2023:

(₹ in millions)

CWIP	Amount in CWIP for a period of				Total
	Less than 1 year	1-2 years	2-3 years	More than 3 years	
Projects in Progress	148.90	81.48	101.57	23.87	355.82
Others	113.35	28.23	-	-	141.58
Total	262.25	109.71	101.57	23.87	497.40

(b) For capital-work-in progress, whose completion is overdue or has exceeded its cost compared to its original plan, following CWIP completion schedule as at 30 June 2023:

(₹ in millions)

CWIP	To be completed in				Total
	Less than 1 year	1-2 years	2-3 years	More than 3 years	
E Beam project	190.46	-	-	-	190.46
Total	190.46	-	-	-	190.46

(₹ in millions)

Particulars	Gross carrying value				Accumulated Depreciation				Net carrying value	
	As at 1 April 2022	Adjustment pursuant to Business Acquisition (Note 51)	Additions	Deletion	As at 30 June 2022	As at 1 April 2022	For the period ended 30 June 2022	Deletion	As at 30 June 2022	As at 30 June 2022
Land - Free Hold	401.24	-	7.40	-	408.64	-	-	-	-	408.64
Buildings	152.66	-	9.68	-	162.34	11.83	0.58	-	12.41	149.93
Factory Buildings	1,266.56	-	132.95	-	1,399.51	227.25	12.51	-	239.76	1,159.75
Worker's Quarters	52.68	-	-	-	52.68	5.58	0.23	-	5.81	46.87
Plant and Equipment	3,222.98	228.47	88.78	0.55	3,539.68	1,348.70	76.06	0.31	1,424.45	2,115.23
Electrical Installations	223.71	3.90	18.44	-	246.05	81.24	4.80	-	86.04	160.01
Furniture and Fixtures	98.35	5.34	27.49	-	131.18	44.39	2.39	-	46.78	84.40
Office and Other Equipment	115.40	13.29	20.54	-	149.23	65.78	4.46	-	70.24	78.99
Vehicles	169.17	15.04	1.06	4.89	180.38	80.92	4.92	3.60	82.24	98.14
Total	5,702.75	266.04	306.34	5.44	6,269.69	1,865.69	105.95	3.91	1,967.73	4,301.96
Capital Work - in - Progress	423.08	-	177.37	282.20	318.25	-	-	-	-	318.25

a) For Capital-work-in progress(CWIP), following is the ageing schedule as on 30 June 2022:

(₹ in millions)

CWIP	Amount in CWIP for a period of				Total
	Less than 1 year	1-2 years	2-3 years	More than 3 years	
Projects in Progress	91.04	101.54	23.87	-	216.45
Others	97.63	4.17	-	-	101.80
Total	188.67	105.71	23.87	-	318.25

(b) For capital-work-in progress, whose completion is overdue or has exceeded its cost compared to its original plan, following CWIP completion schedule as at 30 June 2022:

(₹ in millions)

CWIP	To be completed in				Total
	Less than 1 year	1-2 years	2-3 years	More than 3 years	
E Beam project	-	186.75	-	-	186.75
Total	-	186.75	-	-	186.75

(₹ in millions)

Particulars	Gross carrying value				Accumulated Depreciation				Net carrying value	
	As at 1 April 2022	Adjustment pursuant to Business Acquisition (Note 51)	Additions	Deletion	As at 31 March 2023	As at 1 April 2022	For the year ended 31 March 2023	Deletion	As at 31 March 2023	As at 31 March 2023
Land - Free Hold	401.24	-	7.40	-	408.64	-	-	-	-	408.64
Buildings	152.66	-	16.75	-	169.41	11.83	3.97	-	15.80	153.61
Factory Buildings	1,266.56	-	245.17	-	1,511.73	227.25	51.84	-	279.09	1,232.64
Worker's Quarters	52.68	-	-	-	52.68	5.58	0.93	-	6.51	46.17
Plant and Equipment	3,222.98	228.47	412.01	4.72	3,858.74	1,348.70	322.03	3.26	1,667.47	2,191.27
Electrical Installations	223.71	3.90	22.96	0.01	250.56	81.24	20.99	-	102.23	148.33
Furniture and Fixtures	98.35	5.34	46.58	-	150.27	44.39	14.65	-	59.04	91.23
Office and Other Equipment	115.40	13.29	68.13	13.43	183.39	65.78	26.65	12.60	79.83	103.56
Vehicles	169.17	15.04	31.83	9.21	206.83	80.92	20.08	6.97	94.03	112.80
Total	5,702.75	266.04	850.83	27.37	6,792.25	1,865.69	461.14	22.83	2,304.00	4,488.25
Capital Work - in - Progress	423.08	-	718.65	705.95	435.78	-	-	-	-	435.78

(a) For Capital-work-in progress(CWIP), following is the ageing schedule as on 31 March 2023:

(₹ in millions)

CWIP	Amount in CWIP for a period of				Total
	Less than 1 year	1-2 years	2-3 years	More than 3 years	
Projects in Progress	102.26	128.34	25.82	23.44	279.86
Others	139.33	14.24	2.35	-	155.92
Total	241.59	142.58	28.17	23.44	435.78

(b) For capital-work-in progress, whose completion is overdue or has exceeded its cost compared to its original plan, following CWIP completion schedule as at 31 March 2023:

(₹ in millions)

CWIP	To be completed in				Total
	Less than 1 year	1-2 years	2-3 years	More than 3 years	
E Beam project	185.53	-	-	-	185.53
Total	185.53	-	-	-	185.53

R R KABEL LIMITED
Annexure VI - Notes to Restated Consolidated Financial Information

(₹ in millions)

Particulars	Gross carrying value				Accumulated Depreciation				Net carrying value
	As at 1 April 2021	Additions	Deletion	As at 31 March 2022	As at 1 April 2021	For the year ended 31 March 2022	Deletion	As at 31 March 2022	As at 31 March 2022
Land - Free Hold	388.88	29.72	17.36	401.24	-	-	-	-	401.24
Buildings	151.40	6.22	4.96	152.66	9.92	2.38	0.47	11.83	140.83
Factory Buildings	1,228.51	38.05	-	1,266.56	178.60	48.65	-	227.25	1,039.31
Worker's Quarters	52.68	-	-	52.68	4.65	0.93	-	5.58	47.10
Plant and Equipment	2,984.17	258.67	19.86	3,222.98	1,068.88	293.62	13.80	1,348.70	1,874.28
Electrical Installations	189.00	34.73	0.02	223.71	64.19	17.07	0.02	81.24	142.47
Furniture and Fixtures	90.22	8.32	0.19	98.35	34.90	9.57	0.08	44.39	53.96
Office and Other Equipment	89.65	28.72	2.97	115.40	54.95	13.14	2.31	65.78	49.62
Vehicles	173.39	8.70	12.92	169.17	71.91	18.85	9.84	80.92	88.25
Total	5,347.90	413.13	58.28	5,702.75	1,488.00	404.21	26.52	1,865.69	3,837.06
Capital Work - in - Progress	66.81	601.61	245.34	423.08	-	-	-	-	423.08

(a) For Capital-work-in progress, following is the ageing schedule as on 31 March 2022:

(₹ in millions)

CWIP	Amount in CWIP for a period of				Total
	Less than 1 year	1-2 years	2-3 years	More than 3 years	
Projects in Progress	288.15	25.83	23.44	-	337.42
Others	83.30	2.36	-	-	85.66
Total	371.45	28.19	23.44	-	423.08

(b) For capital-work-in progress, whose completion is overdue or has exceeded its cost compared to its original plan, following CWIP completion schedule as at 31 March 2022:

(₹ in millions)

CWIP	To be completed in				Total
	Less than 1 year	1-2 years	2-3 years	More than 3 years	
E Beam project	190.45	-	-	-	190.45
Total	190.45	-	-	-	190.45

(₹ in millions)

Particulars	Gross carrying value				Accumulated Depreciation				Net carrying value
	As at 1 April 2020	Additions	Deletion	As at 31 March 2021	As at 1 April 2020	For the year ended 31 March 2021	Deletion	As at 31 March 2021	As at 31 March 2021
Land - Free Hold	388.88	-	-	388.88	-	-	-	-	388.88
Buildings	151.40	-	-	151.40	7.52	2.40	-	9.92	141.48
Factory Buildings	1,112.21	116.30	-	1,228.51	131.27	47.33	-	178.60	1,049.91
Worker's Quarters	52.68	-	-	52.68	3.72	0.93	-	4.65	48.03
Plant and Equipment	2,688.96	305.53	10.32	2,984.17	789.85	285.79	6.76	1,068.88	1,915.29
Electrical Installations	184.74	4.26	-	189.00	43.51	20.68	-	64.19	124.81
Furniture and Fixtures	85.36	4.86	-	90.22	25.17	9.73	-	34.90	55.32
Office and Other Equipment	79.43	10.27	0.05	89.65	41.43	13.56	0.04	54.95	34.70
Vehicles	153.82	33.67	14.10	173.39	62.29	18.53	8.91	71.91	101.48
Total	4,897.48	474.89	24.47	5,347.90	1,104.76	398.95	15.71	1,488.00	3,859.90
Capital Work - in - Progress	153.72	315.54	402.45	66.81	-	-	-	-	66.81

R R KABEL LIMITED
Annexure VI - Notes to Restated Consolidated Financial Information

a) For Capital-work-in progress, following is the ageing schedule as on 31 March 2021:

(₹ in millions)

CWIP	Amount in CWIP for a period of				Total
	Less than 1 year	1-2 years	2-3 years	More than 3 years	
Projects in Progress	32.40	23.44	-	-	55.84
Others	10.42	0.55	-	-	10.97
Total	42.82	23.99	-	-	66.81

a) For capital-work-in progress, whose completion is overdue or has exceeded its cost compared to its original plan, following CWIP completion schedule as at 31 March 2021:

(₹ in millions)

CWIP	To be completed in				Total
	Less than 1 year	1-2 years	2-3 years	More than 3 years	
E Beam project	-	58.21	-	-	58.21
Total	-	58.21	-	-	58.21

2.1 : During the period ended 30 June 2023 additions to property, plant and equipment includes Items aggregating to ₹ 0.53 millions ,(period ended 30 June 22 ₹ 0.000 millions, 31 March 2023 ₹ 0.34 millions, 31 March 2022 ₹ 2.84 millions, 31 March 2021 ₹ 4.19 millions) pertaining to Research and Development activities of the Company (Note 41).

2.2 : The details of property, plant and equipment pledged against borrowings are presented in Note 13.3, 13.4, 13.5.

2.3 : The amount of contractual commitments for the acquisition of property, plant and equipment is disclosed in Note 28.

2.4 : No proceedings have been initiated or are pending against the Company for holding any benami property under the Benami Transactions (Prohibition) Act, 1988 (45 of 1988) and rules made thereunder.

2.5 : Building includes warehouse situated at Kolkatta with gross carrying value amounting to ₹ 36.42 millions, title of which is yet to be registered in the name of Company as documents related to the same are in possession with banker of seller.

C) RIGHT OF USE ASSETS

(₹ in millions)

Particulars	Gross carrying value				Accumulated Amortisation				Net carrying value
	As at 1 April 2023	Additions	Deletion	As at 30 June 2023	As at 1 April 2023	For the period ended 30 June 2023	Deletion	As at 30 June 2023	As at 30 June 2023
Right of use Asset (Refer note 40)	797.10	74.58	-	871.68	178.64	29.43	-	208.07	663.61
Total	797.10	74.58	-	871.68	178.64	29.43	-	208.07	663.61

(₹ in millions)

Particulars	Gross carrying value				Accumulated Amortisation				Net carrying value
	As at 1 April 2022	Additions	Deletion	As at 30 June 2022	As at 1 April 2022	For the period ended 30 June 2022	Deletion	As at 30 June 2022	As at 30 June 2022
Right of use Asset (Refer note 40)	196.67	321.98	5.14	513.51	85.50	29.44	0.34	114.60	398.91
Total	196.67	321.98	5.14	513.51	85.50	29.44	0.34	114.60	398.91

(₹ in millions)

Particulars	Gross carrying value				Accumulated Amortisation				Net carrying value
	As at 1 April 2022	Additions	Deletion	As at 31 March 2023	As at 1 April 2022	For the year ended 31 March 2023	Deletion	As at 31 March 2023	As at 31 March 2023
Right of use Asset (Refer note 40)	196.67	637.64	37.21	797.10	85.50	93.48	0.34	178.64	618.46
Total	196.67	637.64	37.21	797.10	85.50	93.48	0.34	178.64	618.46

R R KABEL LIMITED
Annexure VI - Notes to Restated Consolidated Financial Information

(₹ in millions)

Particulars	Gross carrying value				Accumulated Amortisation				Net carrying value
	As at 1 April 2021	Additions	Deletion	As at 31 March 2022	As at 1 April 2021	For the year ended 31 March 2022	Deletion	As at 31 March 2022	As at 31 March 2022
Right of use Asset (Refer note 40)	130.02	73.78	7.13	196.67	48.54	38.60	1.64	85.50	111.17
Total	130.02	73.78	7.13	196.67	48.54	38.60	1.64	85.50	111.17

(₹ in millions)

Particulars	Gross carrying value				Accumulated Amortisation				Net carrying value
	As at 1 April 2020	Additions	Deletion	As at 31 March 2021	As at 1 April 2020	For the year ended 31 March 2021	Deletion	As at 31 March 2021	As at 31 March 2021
Right of use Asset (Refer note 40)	59.77	70.25	-	130.02	18.07	30.47	-	48.54	81.48
Total	59.77	70.25	-	130.02	18.07	30.47	-	48.54	81.48

The aggregate depreciation expense on ROU assets is included under depreciation and amortization expense in the Restated Consolidated Statement of Profit and Loss in Note 26.

D) OTHER INTANGIBLE ASSETS

(₹ in millions)

Particulars	Gross carrying value				Accumulated Amortisation				Net carrying value
	As at 1 April 2023	Additions	Deletion	As at 30 June 2023	As at 1 April 2023	For the period ended 30 June 2023	Deletion	As at 30 June 2023	As at 30 June 2023
Computer Software	43.84	-	-	43.84	39.23	0.40	-	39.63	4.21
Brand	53.00	-	-	53.00	31.78	2.64	-	34.42	18.58
Royalty	50.00	-	-	50.00	22.73	6.22	-	28.95	21.05
Designs	14.80	-	-	14.80	4.49	1.22	-	5.71	9.09
Non-compete Clause	1.88	-	-	1.88	0.43	0.12	-	0.55	1.33
Total	163.52	-	-	163.52	98.66	10.60	-	109.26	54.26

(₹ in millions)

Particulars	Gross carrying value					Accumulated Amortisation				Net carrying value
	As at 1 April 2022	Adjustment pursuant to Business Acquisition (Note 51)	Additions	Deletion	As at 30 June 2022	As at 1 April 2022	For the period ended 30 June 2022	Deletion	As at 30 June 2022	As at 30 June 2022
Computer Software	40.66	2.91	-	-	43.57	35.82	1.80	-	37.62	5.95
Brand	53.00	-	-	-	53.00	21.19	2.68	-	23.87	29.13
Royalty	-	50.00	-	-	50.00	-	3.71	-	3.71	46.29
Designs	-	14.80	-	-	14.80	-	1.10	-	1.10	13.70
Non-compete Clause	-	1.88	-	-	1.88	-	0.14	-	0.14	1.74
Total	93.66	69.59	-	-	163.25	57.01	9.43	-	66.44	96.81
ii) Under development	6.00	-	-	6.00	-	-	-	-	-	-

(₹ in millions)

Particulars	Gross carrying value					Accumulated Amortisation				Net carrying value
	As at 1 April 2022	Adjustment pursuant to Business Acquisition (Note 51)	Additions	Deletion	As at 31 March 2023	As at 1 April 2022	For the year ended 31 March 2023	Deletion	As at 31 March 2023	As at 31 March 2023
Computer Software	40.66	2.91	0.27	-	43.84	35.82	3.41	-	39.23	4.61
Brand	53.00	-	-	-	53.00	21.19	10.59	-	31.78	21.22
Royalty	-	50.00	-	-	50.00	-	22.73	-	22.73	27.27
Designs	-	14.80	-	-	14.80	-	4.49	-	4.49	10.31
Non-compete Clause	-	1.88	-	-	1.88	-	0.43	-	0.43	1.45
Total	93.66	69.59	0.27	-	163.52	57.01	41.65	-	98.66	64.86
ii) Under development	6.00	-	-	6.00	-	-	-	-	-	-

(₹ in millions)

Particulars	Gross carrying value				Accumulated Amortisation				Net carrying value
	As at 1 April 2021	Additions	Deletion	As at 31 March 2022	As at 1 April 2021	For the year ended 31 March 2022	Deletion	As at 31 March 2022	As at 31 March 2022
Computer Software	38.73	1.93	-	40.66	28.39	7.43	-	35.82	4.84
Brand	53.00	-	-	53.00	10.59	10.60	-	21.19	31.81
Total	91.73	1.93	-	93.66	38.98	18.03	-	57.01	36.65
ii) Under development	4.85	6.00	4.85	6.00	-	-	-	-	6.00

A) For Intangible asset under development, following is the ageing schedule as on 31 March 2022:

(₹ in millions)

Intangible asset under development	Amount in CWIP for a period of				Total
	Less than 1 year	1-2 years	2-3 years	More than 3 years	
ERP Upgradation Project	6.00	-	-	-	6.00
Total	6.00	-	-	-	6.00

(₹ in millions)

Particulars	Gross carrying value				Accumulated Amortisation				Net carrying value
	As at 1 April 2020	Additions	Deletion	As at 31 March 2021	As at 1 April 2020	For the year ended 31 March 2021	Deletion	As at 31 March 2021	As at 31 March 2021
Computer Software	38.73	-	-	38.73	20.90	7.49	-	28.39	10.34
Brand	53.00	-	-	53.00	-	10.59	-	10.59	42.41
Total	91.73	-	-	91.73	20.90	18.08	-	38.98	52.75
ii) Under development	-	4.85	-	4.85	-	-	-	-	4.85

a) For Intangible asset under development, following is the ageing schedule as on 31 March 2021:

(₹ in millions)

Intangible asset under development	Amount in CWIP for a period of				Total
	Less than 1 year	1-2 years	2-3 years	More than 3 years	
SCM Project	2.37	-	-	-	2.37
Others	2.48	-	-	-	2.48
Total	4.85	-	-	-	4.85

R R KABEL LIMITED
Annexure VI - Notes to Restated Consolidated Financial Information

(₹ in millions)

Note 3A: INVESTMENTS	Face Value	Non-Current				
		As at 30 June 2023	As at 30 June 2022	As at 31 March 2023	As at 31 March 2022	As at 31 March 2021
Investment accounted for using equity method						
a) Joint venture (measured at cost, Note 1 (b) (xi)) RR-Imperial Electricals Limited - Bangladesh (35%) 22,190,854 Equity shares (period ended 30 June 2022 22,190,854 Equity shares, 31 March 2023 22,190,854 Equity shares, 31 March 2022 22,190,854 Equity shares and 31 March 2021 22,190,854 Equity shares)	Taka 10	200.39	206.16	196.29	216.36	171.43
Investments in equity instruments						
i) Quoted equity shares (fully paid up) (measured at fair value and designated as fair value through other comprehensive income) Ram Ratna Wires Limited 2,821,536 Equity shares (period ended 30 June 2022 1,410,768 Equity shares, 31 March 2023 2,821,536 Equity shares, 31 March 2022 1,410,768 Equity shares and 31 March 2021 1,410,768 Equity shares)	₹ 5	782.37	229.67	446.09	278.91	113.00
Comfort Intech Limited 2,500 Equity shares (period ended 30 June 2022 2,500 Equity shares, 31 March 2023 2,500 Equity shares, 31 March 2022 2,500 Equity shares and 31 March 2021 2,500 Equity shares)	₹ 1 (₹ 10 previous periods)	0.12	0.07	0.07	0.06	0.02
ii) Unquoted Equity Shares (Fully Paid up) (measured at fair value and designated as fair value through other comprehensive income) MEW Electricals Limited 50,000 Equity shares (period ended 30 June 2022 50,000 Equity shares, 31 March 2023 50,000 Equity shares, 31 March 2022 50,000 Equity shares and 31 March 2021 50,000 Equity shares)	₹ 100	136.97	127.85	134.89	126.60	121.56
		1,119.85	563.75	777.34	621.93	406.01
Aggregate amount of quoted investments and market value thereof		782.49	229.74	446.16	278.97	113.02
Aggregate amount of unquoted investments at cost		200.39	206.16	196.29	216.36	171.43
Aggregate of unquoted investments at fair value		136.97	127.85	134.89	126.60	121.56
Aggregate amount of impairment in value of investments		-	-	-	-	-

(₹ in millions)

Note 3B: INVESTMENTS	Current				
	As at 30 June 2023	As at 30 June 2022	As at 31 March 2023	As at 31 March 2022	As at 31 March 2021
Investments in mutual fund instruments (fair value through profit and loss)					
i) UTI Liquid Cash Fund Regular Plan - Growth	209.66	196.99	206.14	224.97	217.60
ii) Axis Treasury Advantage Fund- Regular Growth	453.35	425.34	444.99	423.56	407.25
iii)HDFC Ultra Short Term Fund- Regular Growth	395.09	371.40	388.15	368.80	355.84
iv) Bandhan Low Duration Fund Growth-Regular Plan [erstwhile IDFC Low Duration Fund-Growth Regular Plan]	392.64	368.91	385.60	367.85	354.79
v) UTI Treasury Advantage Fund Regular Growth Plan	476.52	447.20	467.55	444.47	407.03
vi) Axis Liquid Fund Growth	209.88	197.15	206.34	225.09	217.69
vii) UTI overnight fund regular plan growth	654.94	-	750.46	-	-
Aggregate amount of mutual fund investments	2,792.08	2,006.99	2,849.23	2,054.74	1,960.20
Aggregate amount of quoted investments at market value	2,792.08	2,006.99	2,849.23	2,054.74	1,960.20
Aggregate amount of impairment in value of investments	-	-	-	-	-

R R KABEL LIMITED
Annexure VI - Notes to Restated Consolidated Financial Information

(₹ in millions)

Note 4A: LOANS	Non-Current				
	As at 30 June 2023	As at 30 June 2022	As at 31 March 2023	As at 31 March 2022	As at 31 March 2021
Unsecured, considered good :					
Loans to employees	1.99	0.39	2.87	0.52	0.96
	1.99	0.39	2.87	0.52	0.96

(₹ in millions)

Note 4B: LOANS	Current				
	As at 30 June 2023	As at 30 June 2022	As at 31 March 2023	As at 31 March 2022	As at 31 March 2021
Unsecured, considered good :					
Loans to employees	5.20	4.48	0.60	2.20	6.48
	5.20	4.48	0.60	2.20	6.48

(₹ in millions)

Note 5A: OTHER FINANCIAL ASSETS	Non-Current				
	As at 30 June 2023	As at 30 June 2022	As at 31 March 2023	As at 31 March 2022	As at 31 March 2021
Unsecured, considered good:					
Security deposits (Note 5.1)	35.85	21.43	32.41	20.59	15.10
Term deposits held as margin money or security against borrowing, guarantees or other commitments	25.44	0.20	3.35	1.13	0.80
	61.29	21.63	35.76	21.72	15.90

(₹ in millions)

Note 5B: OTHER FINANCIAL ASSETS	Current				
	As at 30 June 2023	As at 30 June 2022	As at 31 March 2023	As at 31 March 2022	As at 31 March 2021
Unsecured, considered good:					
Security deposits (Note 5.1)	7.48	14.92	3.97	19.42	9.93
Term deposits held as margin money or security against borrowing, guarantees or other commitments	25.79	23.51	24.59	20.19	18.21
Interest accrued on term deposits held as margin money or security against borrowing, guarantees or other commitments	1.56	1.68	12.09	1.41	1.11
Derivative assets - mark to market	29.51	30.25	14.03	60.02	4.63
Others (Note 5.2)	111.97	17.98	35.01	17.93	0.86
	176.31	88.34	89.69	118.97	34.74

Note 5.1 Security deposit includes:	As at 30 June 2023	As at 30 June 2022	As at 31 March 2023	As at 31 March 2022	As at 31 March 2021
Deposits given to directors, relatives of directors and firms in which director is a partner	3.13	7.13	3.13	7.13	8.05
Deposits given to a private limited company in which some of the directors are director or member	-	-	-	0.37	0.37

Note 5.2

Other financial assets includes receivable for expenses incurred in relation to Initial Public Offering ("IPO") that will be recovered by the Company from the selling shareholders upon completion of IPO Process.

R R KABEL LIMITED
Annexure VI - Notes to Restated Consolidated Financial Information

(₹ in millions)

Note 6A: NON CURRENT INCOME TAX ASSETS (Net)	As at 30 June 2023	As at 30 June 2022	As at 31 March 2023	As at 31 March 2022	As at 31 March 2021
Income tax (net of provisions)	118.37	151.71	118.34	133.72	52.35
	118.37	151.71	118.34	133.72	52.35

(₹ in millions)

Note 7A: OTHER ASSETS	Non-Current				
	As at 30 June 2023	As at 30 June 2022	As at 31 March 2023	As at 31 March 2022	As at 31 March 2021
Unsecured, considered good:					
Capital advances	326.08	81.69	303.12	35.79	103.62
Balances with government authorities :					
- Value added tax	10.96	11.38	10.96	11.38	16.60
- Service tax and excise duty paid under protest	5.58	5.60	5.58	5.70	5.88
Prepaid expenses	5.98	3.11	4.55	1.00	1.37
Gratuity (Note 35)	0.72	3.79	9.14	12.12	15.87
	349.32	105.57	333.35	65.99	143.34

(₹ in millions)

Note 7B: OTHER ASSETS	Current				
	As at 30 June 2023	As at 30 June 2022	As at 31 March 2023	As at 31 March 2022	As at 31 March 2021
Unsecured, considered good:					
Balances with government authorities:					
- Excise duty	-	-	-	4.48	10.30
- Goods and services tax*	577.81	336.31	619.57	246.07	294.26
- Export incentives and duty scripts	-	-	10.07	-	57.74
Prepaid expenses	71.00	41.33	89.51	60.61	71.44
Advances to suppliers	355.69	791.59	470.47	369.84	401.76
Advance to employees	0.83	5.22	0.81	1.02	1.01
	1,005.33	1,174.45	1,190.43	682.02	836.51

*The Company had filed a writ petition in Honorable Gujarat High Court to ascertain eligibility of credit for taxes paid on certain expenditures incurred in the normal course of business. Based on the management's internal assessment and on the basis of legal view obtained, management expects a favorable outcome from this writ petition and accordingly does not expect any impact on the financial statements or possible / probable outflow of resources on account of this writ petition.

(₹ in millions)

Note 8: INVENTORIES	As at 30 June 2023	As at 30 June 2022	As at 31 March 2023	As at 31 March 2022	As at 31 March 2021
Raw materials (In transit period ended 30 June 23 ₹ 13.80 millions, period ended 30 June 22 ₹ 425.92 millions, 31 March 2023 ₹ 44.04 millions , 31 March 2022 ₹ 330.47 millions and 31 March 2021 ₹ 160.68 millions)	931.62	1,676.84	796.30	1,288.00	804.16
Work-in-progress	1,467.57	1,235.78	1,489.33	1,194.57	988.29
Finished goods (In transit period ended 30 June 23 ₹ 2,090.39 millions, period ended 30 June 22 ₹ 1,577.35 millions, 31 March 2023 ₹ 1851.58 millions , 31 March 2022 ₹ 1678.34 millions and 31 March 2021 ₹ 935.72 millions)	5,514.63	5,198.47	5,595.84	4,182.35	3,176.51
Stock in trade	477.52	526.09	555.00	298.25	266.02
Others:					
Packing materials	74.38	53.58	76.77	52.56	40.20
Scrap	38.70	10.46	19.08	15.50	18.35
Consumable stores and spares	87.83	77.61	68.43	63.77	46.10
Fuel	0.53	0.66	1.02	1.21	0.93
	8,592.78	8,779.49	8,601.77	7,096.21	5,340.56

R R KABEL LIMITED
Annexure VI - Notes to Restated Consolidated Financial Information

8.1 The Company (reversed) / charged inventory write- down (net) of ₹ 113.31 millions during the period ended 30 June 2023 (30 June 2022 ₹ 92.17 millions and years ended 31 March 2023 ₹ 49.65 millions, 31 March 2022 ₹ (36.72) millions and 31 March 2021 ₹ 51.92) to Restated Consolidated Statement of Profit and Loss .

8.2 The inventories are hypothecated as a security as disclosed in Note 13.5.

(₹ in millions)

Note 9: TRADE RECEIVABLES	Current				
	As at 30 June 2023	As at 30 June 2022	As at 31 March 2023	As at 31 March 2022	As at 31 March 2021
Secured, considered good	157.70	178.60	153.39	219.88	253.24
Unsecured, considered good	6,266.18	5,288.33	5,868.13	5,032.05	4,023.52
Trade receivable which have significant increase in credit risk	227.36	236.35	230.32	247.26	265.30
Trade receivable - credit impaired	14.30	14.30	14.30	14.30	21.68
	6,665.54	5,717.58	6,266.14	5,513.49	4,563.74
Allowance for excepted credit loss on Trade Receivables					
Unsecured, considered good	108.65	82.46	102.79	80.47	73.12
Trade receivable which have significant increase in credit risk	227.36	236.35	230.32	247.26	265.30
Trade receivable - credit impaired	14.30	14.30	14.30	14.30	21.68
	6,315.23	5,384.47	5,918.73	5,171.46	4,203.64

The Company's exposure to credit risk, currency risk and market risk related to trade receivables are disclosed in note 37 (C).

Note : Trade receivables includes debts due from group companies and joint venture ₹ 280.42 millions, period ended 30 June 2022 ₹ 412.15 millions, 31 March 2023 ₹ 78.42 millions, 31 March 2022 ₹ 130.08 millions and 31 March 2021 ₹ 294.74 millions).

(₹ in millions)

Note 9.1 Dues from directors or firms or private companies	As at 30 June 2023	As at 30 June 2022	As at 31 March 2023	As at 31 March 2022	As at 31 March 2021
Due from private companies in which director is director or member	2.72	2.54	2.50	2.42	1.26
Due from firm in which director is partner	235.89	373.62	9.19	71.85	174.78

Trade Receivables ageing schedule as at 30 June 2023

(₹ in millions)

Particulars	Unbilled	Outstanding for following periods from due date of the payment					As at 30 June 2023
		Less than 6 months	6 months- 1 Year	1-2 Years	2-3 years	More than 3 years	Total
Undisputed- considered good	-	6,128.07	156.61	58.39	42.36	38.45	6,423.88
Disputed- significant increase in credit risk	-	0.69	0.12	11.50	9.57	205.48	227.36
Disputed- credit impaired	-	-	-	-	-	14.30	14.30
Total	-	6,128.76	156.73	69.89	51.93	258.23	6,665.54

Trade Receivables ageing schedule as at 30 June 2022

(₹ in millions)

Particulars	Unbilled	Outstanding for following periods from due date of the payment					As at 30 June 2022
		Less than 6 months	6 months- 1 Year	1-2 Years	2-3 years	More than 3 years	Total
Undisputed- considered good	-	5,255.48	80.18	49.24	24.79	57.24	5,466.93
Disputed- significant increase in credit risk	-	-	0.64	23.52	59.68	152.51	236.35
Disputed- credit impaired	-	-	-	-	-	14.30	14.30
Total	-	5,255.48	80.82	72.76	84.47	224.05	5,717.58

Trade Receivables ageing schedule as at 31 March 2023

(₹ in millions)

Particulars	Unbilled	Outstanding for following periods from due date of the payment					As at 31 March 2023
		Less than 6 months	6 months- 1 Year	1-2 Years	2-3 years	More than 3 years	Total
Undisputed- considered good	-	5,829.56	63.49	50.84	20.05	57.58	6,021.52
Disputed- significant increase in credit risk	-	0.12	0.53	15.38	37.86	176.43	230.32
Disputed- credit impaired	-	-	-	-	-	14.30	14.30
Total	-	5,829.68	64.02	66.22	57.91	248.31	6,266.14

Trade Receivables ageing schedule as at 31 March 2022

(₹ in millions)

Particulars	Unbilled	Outstanding for following periods from due date of the payment					As at 31 March 2022
		Less than 6 months	6 months- 1 Year	1-2 Years	2-3 years	More than 3 years	Total
Undisputed- considered good	-	5,096.80	47.21	41.06	29.98	36.88	5,251.93
Disputed- significant increase in credit risk	-	-	1.99	36.60	65.42	143.25	247.26
Disputed- credit impaired	-	-	-	-	8.52	5.78	14.30
Total	-	5,096.80	49.20	77.66	103.92	185.91	5,513.49

Trade Receivables ageing schedule as at 31 March 2021

(₹ in millions)

Particulars	Unbilled	Outstanding for following periods from due date of the payment					As at 31 March 2021
		Less than 6 months	6 months- 1 Year	1-2 Years	2-3 years	More than 3 years	Total
Undisputed- considered good	-	4,030.11	70.73	91.94	51.92	32.06	4,276.76
Disputed- significant increase in credit risk	-	3.32	36.08	71.10	62.88	91.92	265.30
Disputed- credit impaired	-	-	3.35	4.03	8.52	5.78	21.68
Total	-	4,033.43	110.16	167.07	123.32	129.76	4,563.74

R R KABEL LIMITED
Annexure VI - Notes to Restated Consolidated Financial Information

(₹ in millions)

Note 10A: CASH AND CASH EQUIVALENTS	As at 30 June 2023	As at 30 June 2022	As at 31 March 2023	As at 31 March 2022	As at 31 March 2021
Balances with bank	151.05	66.75	121.98	72.67	83.45
Cash on hand	0.36	0.32	0.37	0.33	0.51
Term deposits (with original maturity of 3 months or less)	-	-	188.00	50.00	-
	151.41	67.07	310.35	123.00	83.96

(₹ in millions)

Note 10B: BANK BALANCE OTHER THAN CASH AND CASH EQUIVALENTS	As at 30 June 2023	As at 30 June 2022	As at 31 March 2023	As at 31 March 2022	As at 31 March 2021
Earmarked balance with Bank for unclaimed dividend	-	-	0.40	-	0.70
Term deposits (with original maturity of more than 3 months or less than 12 months)	-	-	500.00	-	-
	-	-	500.40	-	0.70

(₹ in millions)

Note 11A: EQUITY SHARE CAPITAL	As at 30 June 2023	As at 30 June 2022	As at 31 March 2023	As at 31 March 2022	As at 31 March 2021
Authorised Capital 120,000,000 (period ended 31 March 2023 120,000,000) Equity Shares of ₹ 5 each, (period ended 30 June 2022 57,000,000, 31 March 2022 57,000,000 and 31 March 2021 57,000,000) Equity Shares of ₹ 10 each	600.00	570.00	600.00	570.00	570.00
Issued, Subscribed and Paid Up Capital 95,696,296 (period ended 31 March 2023 95,696,296,) Equity Shares of ₹ 5 each and (period ended 30 June 2022 2,39,24,074, 31 March 2022 2,39,24,074 and 31 March 2021 2,33,95,276) Equity Shares of ₹ 10 each fully paid	478.48	239.24	478.48	239.24	239.24
	478.48	239.24	478.48	239.24	239.24

(₹ in millions)

NOTE 11B: INSTRUMENT ENTIRELY EQUITY IN NATURE	As at 30 June 2023	As at 30 June 2022	As at 31 March 2023	As at 31 March 2022	As at 31 March 2021
Authorised Capital 3,843,140 (period ended 30 June 2022 3,843,140, 31 March 2023 3,843,140, 31 March 2022 3,843,140 and 31 March 2021 3,843,140) Compulsory Convertible Preference Shares of ₹ 1,080.33 each	4,151.86	4,151.86	4,151.86	4,151.86	4,151.86
Issued, Subscribed and Paid Up Capital 3,843,140 (period ended 30 June 2022 3,843,140, 31 March 2023 3,843,140, 31 March 2022 3,843,140 and 31 March 2021 3,843,140) Compulsory Convertible Preference Shares of ₹ 1,080.33 each fully paid	4,151.86	4,151.86	4,151.86	4,151.86	4,151.86
	4,151.86	4,151.86	4,151.86	4,151.86	4,151.86

R R KABEL LIMITED
Annexure VI - Notes to Restated Consolidated Financial Information

11.1 Reconciliation of Equity Shares outstanding at the beginning and at the end of the period/year	No. of shares	(₹ in millions)
Fully Paid up Equity Shares		
As at 1 April 2020	23,395,276	233.95
Add:- Issued during the year (note 11.9)	528,798	5.29
Closing balance as at 31 March 2021	23,924,074	239.24
Add:- Issued during the year	-	-
As at 31 March 2022	23,924,074	239.24
Add:- Issued during the period	-	-
As at 30 June 2022	23,924,074	239.24
Add:- Issued during the year	-	-
Add:- shares Split during the year	23,924,074	-
Add:- Bonus shares Issued during the year (note 11.9)	47,848,148	239.24
As at 31 March 2023	95,696,296	478.48
Add:- Issued during the year	-	-
As at 30 June 2023	95,696,296	478.48

11.2 Reconciliation of Compulsory Convertible Preference Share outstanding at the beginning and at the end of the period/year	No. of shares	(₹ in millions)
Fully Paid up Equity Shares		
As at 1 April 2020	3,702,572	4,000.00
Add:- Issued during the year (note 11.9)	140,568	151.86
Closing balance as at 31 March 2021	3,843,140	4,151.86
Add:- Issued during the year	-	-
As at 31 March 2022	3,843,140	4,151.86
Add:- Issued during the period	-	-
As at 30 June 2022	3,843,140	4,151.86
Add:- Issued during the year	-	-
As at 31 March 2023	3,843,140	4,151.86
Add:- Issued during the period	-	-
As at 30 June 2023	3,843,140	4,151.86

11.3 Details of shareholders holding more than 5% Equity Shares *	As at 30 June 2023		As at 30 June 2022	
	No. of shares	% of Holding	No. of shares	% of Holding
Mahendrakumar Rameshwarlal Kabra	8,648,588	9.04%	2,162,147	9.04%
Rameshwarlal Kabra (HUF)	-	-	2,267,728	9.48%
TPG Asia VII SF Pte Limited	7,960,512	8.32%	1,990,128	8.32%
Hemant Mahendrakumar Kabra	6,799,436	7.11%	1,699,859	7.11%
Kirtidevi Shreegopal Kabra	5,656,308	5.91%	1,414,077	5.91%
Mahhesh Kabra	5,872,077	6.14%	1,396,084	5.84%
Ram Ratna Research and Holdings Private Limited	5,078,464	5.31%	1,269,616	5.31%
Sumeet Mahendrakumar Kabra	5,537,324	5.79%	2,538,628	2.65%
Tribhuvanprasad Rameshwarlal Kabra	6,896,889	7.21%	1,220,676	5.10%

11.3 Details of shareholders holding more than 5% Equity Shares *	As at 31 March 2023		As at 31 March 2022		As at 31 March 2021	
	No. of shares	% of Holding	No. of shares	% of Holding	No. of shares	% of Holding
Umadevi Tribhuvanprasad Kabra	-	-	3,275,468	13.69%	3,275,468	13.69%
Mahendrakumar Rameshwarlal Kabra	8,648,588	9.04%	2,162,147	9.04%	2,429,278	10.15%
Rameshwarlal Kabra (HUF)	9,070,912	9.48%	2,267,728	9.48%	2,267,728	9.48%
TPG Asia VII SF Pte Limited	7,960,512	8.32%	1,990,128	8.32%	1,990,128	8.32%
Hemant Mahendrakumar Kabra	6,799,436	7.11%	1,699,859	7.11%	1,699,859	7.11%
Kirtidevi Shreegopal Kabra	5,656,308	5.91%	1,414,077	5.91%	1,264,426	5.29%
Mahhesh Kabra	5,584,336	5.84%	577,217	2.41%	577,217	2.41%
Ram Ratna Research and Holdings Private Limited	5,078,464	5.31%	1,269,616	5.31%	1,269,616	5.31%
Tribhuvanprasad Rameshwarlal Kabra	4,882,704	5.10%	565,582	2.36%	565,582	2.36%

R R KABEL LIMITED
Annexure VI - Notes to Restated Consolidated Financial Information

Note : Details of below shareholder holding more than 5 % equity shares in Consolidated Financial Statements for the year ended 31 March 2021 was inadvertently presented which resulted into immaterial difference (refer note B (3) in Annexure VII). The same has now been corrected as under:

Details of shareholder holding more than 5% Equity Shares	As at 31 March 2021			
	As per earlier reported		Revised classification	
	No. of shares	% of Holding	No. of shares	% of Holding
Kirtidevi Shreegopal Kabra	1,248,166	5.22%	1,264,426	5.29%

11.3 Details of shareholders holding more than 5% Compulsory Convertible Preference Shares *	As at 30 June 2023		As at 30 June 2022	
	No. of shares	% of Holding	No. of shares	% of Holding
	TPG Asia VII SF Pte Limited	3,843,140	100.00%	3,843,140

11.3 Details of shareholders holding more than 5% Compulsory Convertible Preference Shares *	As at 31 March 2023		As at 31 March 2022		As at 31 March 2021	
	No. of shares	% of Holding	No. of shares	% of Holding	No. of shares	% of Holding
	TPG Asia VII SF Pte Limited	3,843,140	100.00%	3,843,140	100.00%	3,843,140

* As per the records of the company, including its register of members

11.4 Details of Shares held by promoter at the end of the period /year

Promoter Name	As at 30 June 2023			As at 30 June 2022		
	No of Shares	% of total shares	% change during the period	No of Shares	% of total shares	% change during the period
Mahendrakumar Rameshwarlal Kabra	8,648,588	9.04%	-	2,162,147	9.03%	-1.12%
Kirtidevi Shreegopal Kabra	5,656,308	5.91%	-	1,414,077	5.92%	0.63%
Shreegopal Rameshwarlal Kabra	4,629,232	4.84%	1.67%	748,606	3.13%	0.21%
Tribhuvanprasad Rameshwarlal Kabra	6,896,889	7.21%	2.11%	565,582	2.36%	-
Kabra Shreegopal Rameshwarlal (HUF)	3,961,160	4.14%	-	980,290	4.10%	-
Mahendra Kumar Kabra (HUF)	1,154,208	1.21%	-	288,552	1.21%	-
Tribhuvanprasad Kabra (HUF)	1,436,000	1.50%	-	359,000	1.50%	-
Total			3.78%			-0.28%

Promoter Name	As at 31 March 2023			As at 31 March 2022			As at 31 March 2021		
	No of Shares	% of total shares	% change during the year	No of Shares	% of total shares	% change during the year	No of Shares	% of total shares	% change during the year
Mahendrakumar Rameshwarlal Kabra	8,648,588	9.04%	-	2,162,147	9.03%	-1.12%	2,429,278	10.15%	0.21%
Kirtidevi Shreegopal Kabra	5,656,308	5.91%	-	1,414,077	5.92%	0.63%	1,264,426	5.29%	-0.05%
Shreegopal Rameshwarlal Kabra	3,034,424	3.17%	0.04%	748,606	3.13%	0.21%	698,956	2.92%	-0.07%
Tribhuvanprasad Rameshwarlal Kabra	4,882,704	5.10%	2.74%	565,582	2.36%	-	565,582	2.37%	-0.05%
Kabra Shreegopal Rameshwarlal (HUF)	3,961,160	4.14%	0.04%	980,290	4.10%	-	980,290	4.10%	-0.09%
Mahendra Kumar Kabra (HUF)	1,154,208	1.21%	-	288,552	1.21%	-	288,552	1.21%	0.01%
Tribhuvanprasad Kabra (HUF)	1,436,000	1.50%	-	359,000	1.50%	-	359,000	1.50%	-0.03%
			2.82%			-0.28%			-0.07%

Note : Pursuant to board meeting held on 13 February 2023, the Company has revised the list of promoters resulting into decrease in number of promoters from 41 to 7. Consequently, the Company has updated its annual return for the financial year 2021-22, 2020-21 filed with Registrar of Companies (RoC) . Accordingly, the financial information included in RCFI for the years ended 31 March 2022, 31 March 2021 have been restated.

11.5 Terms/ rights attached to Equity shares:

The Company has only one class of equity shares having face value of ₹ 5/- per share. Each holder of equity shares is entitled to one vote per share. The dividend proposed by the Board of Directors is subject to approval of the Shareholders in the ensuring Annual General Meeting, except in the case of interim dividend.

As per the Companies Act, 2013 the holders of equity shares will be entitled to receive remaining assets of the Company, after the distribution of all preferential amounts in the event of the liquidation of the Company. The distribution will be in proportion to the number of equity shares held by the Shareholders.

11.6 Terms/ rights attached to Preference shares:

The Company has only one class of Compulsory Convertible Preference shares (CCPS) having nominal value of ₹ 1,080.33/- per share. These CCPS shall rank pari-passu in all respects (including with respect to dividend and voting rights) with the then-existing Equity Shares of the Company. Post conversion to equity, these CCPS shall have the same right as of the equity shareholders.

11.7 The Board of Directors of the Company, at its meeting held on September 06, 2018 had approved a proposal to buy back of upto 7,50,724 equity shares for an aggregate amount of ₹ 811.03 Millions (excluding tax on distributed income) being 3.11% of the total paid up equity share capital at ₹ 1,080.33 per equity share, which was approved by the shareholders by means of a special resolution in Extra Ordinary General Meeting held on September 11, 2018.

R R KABEL LIMITED

Annexure VI - Notes to Restated Consolidated Financial Information

A Letter of Offer was made to all eligible shareholders. The Company bought back 7,50,724 equity shares out of the shares that were tendered by eligible shareholders and extinguished the equity shares bought on October 31, 2018.

The excess of cost of buy-back of ₹ 997.15 millions (including ₹ 186.12 millions towards tax on distributed income) over par value of shares was offset from Securities Premium ₹ 130.08 millions, General Reserve ₹ 300.00 millions and retained earnings ₹ 559.56 millions. The company has transferred an amount equivalent to face value of ₹ 7.51 millions from retained earnings to Capital Redemption Reserve in accordance with Act.

11.8 The Board of Directors of the Company, at its meeting held on September 06, 2018 had approved the proposal to issue 37,02,572 Compulsory Convertible Preference Shares (CCPS) to TPG Asia VII SF Pte Ltd (the Investor). These CCPS are issued pursuant to Shareholder's Agreement and Securities Subscription and Share Purchase Agreement among the Company, the Promoters and the Investor.

These CCPS shall be convertible into Equity Shares on the specified conversion dates at a specified conversion ratio in accordance with and upon the terms and conditions as set out in the Securities Subscription and Share Purchase Agreement.

11.9 Aggregate number of equity shares allotted as fully paid up pursuant to contract without consideration received in cash, bonus shares issued and shares bought back during the period of 5 years immediately preceding the Balance sheet date:

i) The Company has issued 5,28,798 fully paid up equity shares of ₹ 10 each to the equity shares holders of Ram Ratna Electrical Limited and 1,40,568 Compulsory Convertible Preference Shares (CCPS) of ₹ 1,080.33 to the preference shares holders of Ram Ratna Electrical Limited pursuant to scheme of amalgamation for consideration other than cash during the year ended 31 March 2020.

ii) 47,848,148 equity Shares have been allotted by way of Bonus during the year ended 31 March 2023.

iii) 23,924,074 equity shares having face value of ₹ 10 each are split into face value of ₹ 5 each during the year ended 31 March 2023 .

(₹ in millions)

Note 12: OTHER EQUITY	As at 30 June 2023	As at 30 June 2022	As at 31 March 2023	As at 31 March 2022	As at 31 March 2021
Reserves and surplus					
a) Capital Redemption Reserve					
Balance at the beginning of period/year	-	7.51	7.51	7.51	7.51
Changes during period/year	-	-	(7.51)	-	-
Balance at end of the period/year	-	7.51	-	7.51	7.51
b) Capital Reserve					
Balance at the beginning of period/year	292.21	125.05	125.05	125.05	125.05
Changes during period/year	-	167.16	167.16	-	-
Balance at end of the period/year	292.21	292.21	292.21	125.05	125.05
C) Retained Earnings					
Balance at the beginning of period/year	8,836.76	7,672.98	7,672.98	5,816.69	4,459.69
Profit for the period/year	743.48	181.42	1,898.72	2,139.37	1,353.98
Dividends	-	-	(499.81)	(277.67)	-
Issue of bonus share	-	-	(231.73)	-	-
Re-measurement of post employment benefits obligation	(0.85)	(1.35)	(3.40)	(5.41)	3.02
Balance at end of the period/year	9,579.39	7,853.05	8,836.76	7,672.98	5,816.69
d) Share based payment reserve outstanding					
Balance at the beginning of period/year	12.56	7.52	7.52	-	-
Created during period/year	3.18	2.86	5.04	7.52	-
Balance at end of the period/year	15.74	10.38	12.56	7.52	-
Other comprehensive income					
e) Equity Instruments through Other comprehensive income					
Balance at the beginning of period/year	422.93	267.21	267.21	97.26	23.70
Increase/(decrease) on account of change in fair value of investments	298.89	(42.57)	155.72	169.95	73.56
Balance at end of the period/year	721.82	224.64	422.93	267.21	97.26
f) Foreign currency translation reserve					
Balance at the beginning of period/year	2.15	31.66	31.66	28.70	33.40
Increase/(decrease) during the period/year	(2.57)	(8.37)	(29.51)	2.96	(4.70)
Balance at end of the period/year	(0.42)	23.29	2.15	31.66	28.70
g) Share suspense account					
Balance at the beginning of period/year	-	-	-	-	157.15
Shares issued pursuant to scheme of amalgamation (refer note 50)	-	-	-	-	(157.15)
Balance at end of the period/year	-	-	-	-	-
	10,608.74	8,411.08	9,566.61	8,111.93	6,075.21

(₹ in millions)

Note 13A: BORROWINGS	Non-Current				
	As at 30 June 2023	As at 30 June 2022	As at 31 March 2023	As at 31 March 2022	As at 31 March 2021
Secured					
Term Loans from Bank					
Rupee Loans (Refer Note 13.1 and 13.3)	187.49	437.47	249.98	499.96	487.50
Term loan from financial institution					
Rupee loans (Refer Note 13.1 and 13.3)	-	74.45	18.61	93.06	224.18
Vehicle loans (Refer note 13.2 and 13.4)	-	-	-	0.11	1.14
	187.49	511.92	268.59	593.13	712.82

R R KABEL LIMITED
Annexure VI - Notes to Restated Consolidated Financial Information

(₹ in millions)

Note 13B: BORROWINGS	Current				
	As at 30 June 2023	As at 30 June 2022	As at 31 March 2023	As at 31 March 2022	As at 31 March 2021
Secured					
Working capital loans					
From banks					
Foreign currency loans (Refer Note 13.5)	-	-	-	507.91	-
Rupee loans					
Short term (Refer Note 13.5)	2,806.51	2,648.85	3,320.10	2,269.64	3,442.14
Repayable on demand (Refer Note 13.5)	20.78	357.90	360.39	256.91	177.16
Current maturities of long term borrowings					
Rupee loans (Note 13.1 & 13.3)	324.43	362.21	324.43	381.09	312.50
Vehicle loans (Note 13.2 & 13.4)	-	0.37	-	0.82	3.18
Unsecured					
Working capital loans					
From banks					
Rupee loans - short term (Refer Note 13.5 (e))	681.55	1,135.73	864.93	1,192.56	330.55
Interest accrued*	16.89	12.94	19.97	9.05	8.78
	3,850.16	4,518.00	4,889.82	4,617.98	4,274.31

*Interest accrued pertaining to borrowing is reclassified from other financial liabilities to borrowings for the years ended 31 March 2022 and 31 March 2021 pursuant to requirements of Schedule III of the Companies Act, 2013. (refer note B (3) in Annexure VII).

Notes to 13A and 13B

(₹ in millions)

Note 13.1 : Term Loans (Rupee Loans)	Maturity Profile*	Rate of Interest for period ended 30 June 2022, 30 June 2023 and years ended 31 March 2021, 31 March 2022, 31 March 2023	As at	As at	As at	As at	As at
			30 June 2023	30 June 2022	31 March 2023	31 March 2022	31 March 2021
Term Loan I-CITICorp Financial Institution	16 Instalments from January 2019 to October 2022	8.15%	-	24.87	-	37.31	87.06
Term Loan II-CITICorp Financial Institution	16 Instalments from March 2019 to December 2022	8.15%	-	12.90	-	19.35	45.16
Term Loan III-CITICorp Financial Institution	16 Instalments from August 2020 to May 2024	8.95%	74.44	148.91	93.06	167.51	241.96
Term Loan V-HDFC Bank	16 Instalments from June 2021 to October 2025	7.25%-8.20%	83.49	206.25	95.41	224.99	300.00
Term Loan VI-HDFC Bank	16 Instalments from June 2021 to October 2025	7.25%-8.20%	153.13	240.63	175.00	262.50	350.00
Term Loan VII-HDFC Bank	16 Instalments from June 2021 to October 2025	7.25%-8.20%	131.25	109.38	150.00	119.33	-
Term Loan VIII-HDFC Bank	16 Instalments from Sept 2021 to March 2025	7.25%-8.20%	69.61	131.19	79.55	143.12	-
			511.92	874.13	593.02	974.11	1,024.18
Less : Current maturities of long term borrowing under "Borrowings" (Note 13 B)			324.43	362.21	324.43	381.09	312.50
			187.49	511.92	268.59	593.02	711.68

*The above maturity profile is excluding accrued interest.

R R KABEL LIMITED
Annexure VI - Notes to Restated Consolidated Financial Information

(₹ in millions)

Note 13.2 : Vehicle Loans	Maturity Profile*	Rate of Interest for period ended			As at 30 June 2023	As at 30 June 2022	As at 31 March 2023	As at 31 March 2022	As at 31 March 2021
		30 June 2022, 30 June 2023	31 March 2021, 31 March 2022, 31 March 2023						
Vehicles Loans	24 to 60 Instalments from November 15 to July 23	7.70% - 11%			-	0.37	-	0.93	4.32
Less : Current maturities of long term borrowing under "Borrowings" (Note 13 B)					-	0.37	-	0.82	3.18
					-	-	-	0.11	1.14

*The above maturity profile is excluding accrued interest.

Note 13.3 :

- (a) Term Loans from Citicorp Finance India Limited Bank of ₹ 74.45 (Period ended 30 June 2022 ₹ 186.67 millions , 31 March 2023 ₹ 93.06 millions ,31 March 2022 ₹ 224.17 millions and 31 March 2021 ₹ 374.18 millions) are secured by way of first pari-passu charge with the Security Trustee over various immovable properties at Waghodia and Nawa Ajwa in the District of Vadodara, State Gujarat as per register mortgage deed. Term loans are further secured by all the present and future movable fixed assets (excluding vehicles) of the Company. These loans are also secured by second pari-passu charge with the Security Trustee over the present and future current assets of the Company. Further personal guarantees for term loan given by Mr Tribhuvan Prasad Kabra, Mr Mahendra Kumar Kabra, Mr Shreegopal Kabra, Mr Mahhesh Kabra and Mr Sumeet Kabra.
- (b) Term Loan of HDFC Bank ₹ 437.48 millions, (period ended 30 June 2022 ₹ 687.45 , 31 March 2023 ₹ 499.96 millions, 31 March 2022 ₹ 749.95 millions and 31 March 2021 ₹ 650.00 millions) are secured by way of first charge with the Security Trustee over various immovable properties at Waghodia and Nawa Ajwa in the District of Vadodara, State Gujarat as per register mortgage deed. Term loans are further secured by present and future movable fixed assets of the Company. These loans are also secured by second charge with the Security Trustee over the present and future current assets of the Company. Further personal guarantees for term loan given by Mr Tribhuvan Prasad Kabra, Mr Mahendra Kumar Kabra, Mr Shreegopal Kabra, Mr Mahhesh Kabra and Mr Sumeet Kabra.

Note 13.4 : Vehicle loans are secured by way of hypothecation of specific vehicle.

Note 13.5 :

- (a) All secured working capital facilities consisting of Foreign Currency Loan ₹ 00.00, (Period ended 30 June 2022 ₹ 00.00 millions, 31 March 2023 ₹ 00.00 million, 31 March 2022 ₹ 507.9 millions, 31 March 2021 ₹ 00.00 millions), Working Capital Loans of ₹ 2806.51 millions, (period ended 30 June 2022 ₹ 2648.85.02 millions, 31 March 2023 ₹ 3320.10 millions, 31 March 2022 ₹ 2,269.64 millions, and 31 March 2021 ₹ 3,442.14 millions,) and Rupee Loan - Repayable of demand of ₹ 20.78 millions (period ended 30 June 2022 ₹ 357.90 millions, 31 March 31,2023 ₹ 360.39 millions, 31 March 2022 ₹ 256.91 millions and 31 March 2021 ₹ 177.16 millions) are secured by way of second pari-passu charge with the Security Trustee over various immovable properties at Waghodia and Nawa Ajwa in the District of Vadodara, State Gujarat as per register mortgage deed.
- (b) These loans are further secured by second pari-passu charge over the present and future movable fixed assets (excluding vehicles) of the Company
- (c) These loans are also secured by first pari-passu charge with the Security Trustee over the present and future current assets of the Company.
- (d) Further personal guarantees for working capital loan given by Mr Tribhuvan Prasad Kabra, Mr Mahendra Kumar Kabra, Mr Shreegopal Kabra, Mr Mahhesh Kabra and Mr Sumeet Kabra.
- (e) Working Capital demand loans carry interest rate from 6.95% to 8.95% (period ended 30 June 2022 5.40 to 8.95 % 31 March 2023 5.40 to 9.20 % , 31 March 2022 7.70% to 9.15% and 31 March 2021 7.70% to 9.10% with different tenure.”

Note 13.6 : There is no default in terms of repayment of principal and interest amount.

Note 13.7 : All the charges created or satisfied during the period ended 30 June 23, 30 June 22 and year ended 31 March 23, 31 March 22 and 31 March 21 were registered with Registrar of companies within statutory period.

Note 13.8 : Bank returns / stock statements filed by the Company with its bankers are in agreement with books of account except as shown below and which has been rectified and revised numbers have been submitted to Banks for period ended March 2023.

R R KABEL LIMITED
Annexure VI - Notes to Restated Consolidated Financial Information

(₹ in millions)

Name of Bank	Quarter	Particulars	For the period ended 31 March 2023			Reason for discrepancies
			Amounts as per the Books of Accounts	Amounts as reported in the Quarterly Return Statement	Amounts of Difference	
DBS BANK, HDFC BANK, HSBC BANK KOTAK BANK STATE BANK OF INDIA SCB BANK	1	Inventory	6,655.13	6,647.85	(7.28)	Fuel, Consumable, Stores & Spares stock not reported to Bank.
		Trade Receivable	7,260.59	6,978.61	(281.98)	Trade receivables pertaining to recent acquisition of Home Electrical Business (HEB) in FEMG segment were reported to banks as net of transactions (i.e. revenues recognised less collections received) for the month of June 2022 instead of closing balance of trade receivables as at 30 June 2022. This resulted into lower balance being reported inadvertently to banks for the Quarter - 1 as compared to the book balances.
		Trade payable	2,234.20	1,830.34	(403.86)	Certain trade payables pertaining to recent acquisition of HEB in FMEG segment were reported as advances to suppliers instead of trade payables as appearing in the books. This resulted into lower balance being reported inadvertently to banks for Quarter 1 as compared to book balances.
	2	Inventory	5,755.02	5,752.79	(2.23)	Fuel, Consumable, Stores & Spares stock not reported to Bank.
		Trade Receivable	7,480.45	7,480.36	(0.09)	
		Trade payable	1,892.73	1,892.79	0.06	
	3	Inventory	5,443.64	5,441.59	(2.05)	Fuel, Consumable, Stores & Spares stock not reported to Bank.
		Trade Receivable	8,144.50	8,144.60	0.10	
		Trade payable	2,303.90	2,303.90	-	

(₹ in millions)

Name of Bank	Quarter	Particulars	For the year ended 31 March 2022			Reason for discrepancies
			Amounts as per the Books of Accounts	Amounts as reported in the Quarterly Return Statement	Amounts of Difference	
DBS BANK, HDFC BANK, HSBC BANK KOTAK BANK STATE BANK OF INDIA SCB BANK	1	Inventory	5,202.69	5,253.79	51.10	Certain inventories and provision for inventories pertaining to recent acquisition or amalgamation in consumer electrical business were not included since the operations of the same were at nascent / incubation stage.
		Trade Receivable	5,309.38	5,221.38	(88.00)	Receivables pertaining to recent acquisition in consumer electrical business were not included since the operations of the same were at nascent / incubation stage.
		Trade payable	451.24	455.56	4.32	Payables pertaining to recent acquisition in consumer electrical business were not included since the operations of the same were at nascent / incubation stage.
	2	Inventory	4,622.30	4,636.38	14.08	Certain inventories and provision for inventories pertaining to recent acquisition or amalgamation in consumer electrical business were not included since the operations of the same were at nascent / incubation stage.
		Trade Receivable	5,937.43	5,893.57	(43.86)	Receivables pertaining to recent acquisition in consumer electrical business were not included since the operations of the same were at nascent / incubation stage.
		Trade payable	494.11	511.23	17.12	Payables pertaining to recent acquisition in consumer electrical business were not included since the operations of the same were at nascent / incubation stage.
	3	Inventory	5,264.18	5,188.14	(76.04)	Certain inventories and provision for inventories pertaining to recent acquisition or amalgamation in consumer electrical business were not included since the operations of the same were at nascent / incubation stage.
		Trade Receivable	6,327.80	6,280.60	(47.20)	Receivables pertaining to recent acquisition in consumer electrical business were not included since the operations of the same were at nascent / incubation stage.
		Trade payable	418.81	432.83	14.02	Payables pertaining to recent acquisition in consumer electrical business were not included since the operations of the same were at nascent / incubation stage.
	4	Inventory	5,025.51	5,051.37	25.86	Certain inventories and provision for inventories pertaining to recent acquisition or amalgamation in consumer electrical business were not included since the operations of the same were at nascent / incubation stage.
		Trade Receivable	7,332.55	7,331.49	(1.06)	Receivables pertaining to recent acquisition in consumer electrical business were not included since the operations of the same were at nascent / incubation stage which is offset by credit notes issued to customers at year end.
		Trade payable	369.52	409.35	39.83	Payables pertaining to recent acquisition in consumer electrical business were not included since the operations of the same were at nascent / incubation stage.

Name of Bank	Quarter	Particulars	For the year ended 31 March 2021			Reason for discrepancies
			Amounts as per the Books of Accounts	Amounts as reported in the Quarterly Return Statement	Amounts of Difference	
DBS BANK, HDFC BANK, HSBC BANK KOTAK BANK STATE BANK OF INDIA SCB BANK	1	Inventory	2,418.32	2,364.84	(53.48)	Inventories pertaining to consumables, stores and spares were not included considering the amount involved was immaterial or Certain inventories and provision for inventories pertaining to recent acquisition or amalgamation in consumer electrical business were not included since the operations of the same were at nascent / incubation stage.
		Trade Receivable	4,111.40	4,110.40	(1.00)	Receivables pertaining to recent acquisition in consumer electrical business were not included since the operations of the same were at nascent / incubation stage.
		Trade payable	101.70	101.70	-	
	2	Inventory	3,011.65	3,017.65	6.00	Certain inventories and provision for inventories pertaining to recent acquisition or amalgamation in consumer electrical business were not included since the operations of the same were at nascent / incubation stage.
		Trade Receivable	4,683.36	4,668.79	(14.57)	Receivables pertaining to recent acquisition in consumer electrical business were not included since the operations of the same were at nascent / incubation stage.
		Trade payable	323.48	313.13	(10.35)	Payables pertaining to recent acquisition in consumer electrical business were not included since the operations of the same were at nascent / incubation stage.
	3	Inventory	3,480.80	3,509.24	28.44	Certain inventories and provision for inventories pertaining to recent acquisition or amalgamation in consumer electrical business were not included since the operations of the same were at nascent / incubation stage.
		Trade Receivable	5,122.24	5,103.89	(18.35)	Receivables pertaining to recent acquisition in consumer electrical business were not included since the operations of the same were at nascent / incubation stage.
		Trade payable	220.86	212.18	(8.68)	Payables pertaining to recent acquisition in consumer electrical business were not included since the operations of the same were at nascent / incubation stage.
	4	Inventory	4,244.15	4,355.77	111.62	Certain inventories and provision for inventories pertaining to recent acquisition or amalgamation in consumer electrical business were not included since the operations of the same were at nascent / incubation stage.
		Trade Receivable	5,590.37	5,575.86	(14.51)	Receivables pertaining to recent acquisition in consumer electrical business were not included since the operations of the same were at nascent / incubation stage which is offset by credit notes issued to customers at year end.
		Trade payable	229.65	210.28	(19.37)	Payables pertaining to recent acquisition in consumer electrical business were not included since the operations of the same were at nascent / incubation stage.

Note 13.9 : Term loans were applied for the purpose for which the loans were obtained.

Note 13.10 : Funds raised on short term basis have not been utilised for long term purposes and spent for the purpose it were obtained.

R R KABEL LIMITED
Annexure VI - Notes to Restated Consolidated Financial Information

(₹ in millions)

Note 14A: LEASE LIABILITIES	Non-Current				
	As at 30 June 2023	As at 30 June 2022	As at 31 March 2023	As at 31 March 2022	As at 31 March 2021
Lease liabilities(Note 40)	613.88	358.26	564.05	82.27	52.64
	613.88	358.26	564.05	82.27	52.64

(₹ in millions)

Note 14B: LEASE LIABILITIES	Current				
	As at 30 June 2023	As at 30 June 2022	As at 31 March 2023	As at 31 March 2022	As at 31 March 2021
Lease liabilities(Note 40)	83.42	48.67	81.95	32.51	30.66
	83.42	48.67	81.95	32.51	30.66

(₹ in millions)

Note 15A: OTHER FINANCIAL LIABILITIES	Non-Current				
	As at 30 June 2023	As at 30 June 2022	As at 31 March 2023	As at 31 March 2022	As at 31 March 2021
Retention money relating to capital expenditure	21.89	19.23	21.29	-	-
	21.89	19.23	21.29	-	-

(₹ in millions)

Note 15B: OTHER FINANCIAL LIABILITIES	Current				
	As at 30 June 2023	As at 30 June 2022	As at 31 March 2023	As at 31 March 2022	As at 31 March 2021
Retention money relating to capital expenditure	21.45	32.18	29.36	44.05	16.67
Interest accrued and due on borrowings	23.75	7.33	19.82	6.35	2.23
Accrued salary and benefits	187.09	161.27	145.45	102.37	69.21
Commission to directors	9.88	2.56	26.40	27.23	19.23
Derivative liabilities - mark to market	8.17	35.35	22.24	0.07	3.99
Creditors for capital expenditure	70.50	36.89	61.45	27.39	19.98
Security deposits	59.37	48.57	55.87	24.87	23.27
Unclaimed dividends	-	-	0.40	-	0.70
Other payables	0.66	-	16.73	8.16	9.54
	380.87	324.15	377.72	240.49	164.82

Note 15B .1 Interest accrued on borrowing is reclassified from other financial liabilities to borrowings for the years ended 31 March 2022, 31 March 2021 pursuant to requirements of Schedule III of the Companies Act, 2013. (refer note B (3) in Annexure VII).

R R KABEL LIMITED
Annexure VI - Notes to Restated Consolidated Financial Information

(₹ in millions)

Note 16A: PROVISIONS	Non-Current				
	As at 30 June 2023	As at 30 June 2022	As at 31 March 2023	As at 31 March 2022	As at 31 March 2021
Provision for Employee Benefits					
Compensated absences (Note 35C)	153.70	82.25	140.81	71.72	60.44
	153.70	82.25	140.81	71.72	60.44

(₹ in millions)

Note 16B: PROVISIONS	Current				
	As at 30 June 2023	As at 30 June 2022	As at 31 March 2023	As at 31 March 2022	As at 31 March 2021
Provision for Employee Benefits					
Compensated absences (Note 35C)	33.50	49.38	28.50	43.06	32.96
Provision for warranty (Note 16B.1)	206.03	175.57	193.42	96.93	21.68
	239.53	224.95	221.92	139.99	54.64

Note 16B.1

The provision of warranty as required to be disclosed in compliance with Ind AS 37, Provisions, Contingent liabilities and Contingent Assets's as under :

(₹ in millions)

Particulars	As at 30 June 2023	As at 30 June 2022	As at 31 March 2023	As at 31 March 2022	As at 31 March 2021
Opening Balance	193.42	96.93	96.93	21.68	-
Acquired on account of business acquisition (Note 51)	-	58.88	58.88	-	-
Created during the year	40.18	59.96	104.87	148.18	83.66
Utilised during the year	27.57	40.20	67.26	72.93	61.98
Closing Balance	206.03	175.57	193.42	96.93	21.68

Note :

- i) Warranty costs are provided based on a estimates of the cost required to be incurred for repairs, replacement, material cost, servicing, and past experience in respect of warranty costs.

R R KABEL LIMITED
Annexure VI - Notes to Restated Consolidated Financial Information

(₹ in millions)

Note 17: INCOME TAXES	As at 30 June 2023	As at 30 June 2022	As at 31 March 2023	As at 31 March 2022	As at 31 March 2021
A. The major components of income tax expenses for the period/year are as under :					
(i) Income tax expenses recognised in the Restated Consolidated Statement of Profit and Loss					
Current Tax :-					
In respect of current year	247.25	64.15	658.32	648.27	489.12
(Excess)/short in respect of preceding years	-	-	3.87	2.99	(7.89)
Deferred Tax :-					
In respect of current year	3.15	0.66	(1.00)	52.96	(20.87)
Income tax expenses recognised in Restated Consolidated Statement of Profit and Loss	250.40	64.81	661.19	704.22	460.36
(ii) Income tax expenses recognised in the OCI					
Deferred Tax :-					
Deferred tax on fair value of equity instruments through OCI	(39.51)	5.40	(19.77)	(1.03)	(6.99)
Deferred tax on re-measurement of post employment benefits obligation	0.29	0.46	1.14	1.82	(1.02)
	(39.22)	5.86	(18.63)	0.79	(8.01)
B. Reconciliation of estimated income tax expenses and the accounting profit for the period/year is as under:					
Profit before share of profit of joint venture and tax	987.22	248.06	2,550.47	2,801.62	1,803.36
Expected income tax expense at statutory income tax rate	248.46	62.43	641.90	705.11	453.86
Tax adjustment of earlier years	-	-	3.87	2.99	(7.89)
Tax effect on non deductible expenses	2.21	11.67	18.13	13.83	6.66
Effect of incentive tax credits	-	-	-	(0.19)	6.46
Others	(0.27)	(9.29)	(2.71)	(17.52)	1.27
Tax expense as per Restated Consolidated Statement of Profit and Loss for the period/year	250.40	64.81	661.19	704.22	460.36
Effective rate of Tax	25.36%	26.13%	25.92%	25.14%	25.53%
Statutory rate of Tax	25.17%	25.17%	25.17%	25.17%	25.17%

Note 17.1 : The tax rate used for the 30 June 2023, 30 June 2022, 31 March 2023 and 31 March 2022 and 31 March 2021 reconciles above with the corporate tax rate of 25.17%, payable by corporate entities in India on taxable profits under Indian Income Tax Laws.

(₹ in millions)

C: The major components of deferred tax liabilities/(assets) arising on account of timing differences are as follows:	As at 01 April 2023	Recognized in Profit and Loss	Recognized in Other Comprehensive Income	As at 30 June 2023
Deferred tax liabilities				
Difference between written down value as per books of account and Income Tax Act, 1961.	173.24	(1.60)	-	171.64
Difference in carrying value and tax base of investments in equity measured at FVTOCI	46.40	-	39.51	85.91
Difference in carrying value and tax base of investments in Mutual Fund	61.45	8.69	-	70.14
Mark to market exchange gain and loss	(2.07)	1.67	-	(0.40)
Deferred tax assets				
Provision for expenses allowed for tax purpose on payment basis (net)	(28.11)	(3.81)	-	(31.92)
Allowance for expected credit loss on trade receivable	(87.44)	(0.17)	-	(87.61)
Rou assets and Lease liabilities	(6.93)	(1.70)	-	(8.63)
Merger expenses of RREL	(0.50)	0.07	-	(0.43)
Re-measurement of post employment benefits obligation	(7.37)	-	(0.29)	(7.66)
Net Deferred tax liabilities	148.67	3.15	39.22	191.04

R R KABEL LIMITED
Annexure VI - Notes to Restated Consolidated Financial Information

(₹ in millions)

C: The major components of deferred tax liabilities/(assets) arising on account of timing differences are as follows:	As at 01 April 2022	Recognized in Profit and Loss	Recognized in Other Comprehensive Income	As at 31 March 2023
Deferred tax liabilities				
Difference between written down value as per books of account and Income Tax Act, 1961.	167.05	6.19	-	173.24
Difference in carrying value and tax base of investments in equity measured at FVTOCI	50.42	(23.79)	19.77	46.40
Difference in carrying value and tax base of investments in Mutual Fund	27.69	33.76	-	61.45
Mark to market exchange gain and loss	0.16	(2.23)	-	(2.07)
Deferred tax assets				
Provision for expenses allowed for tax purpose on payment basis (net)	(15.93)	(12.18)	-	(28.11)
Allowance for expected credit loss on trade receivable	(86.08)	(1.36)	-	(87.44)
Provision for advance given to supplier	(3.93)	3.93	-	-
Rou assets and Lease liabilities	(0.91)	(6.02)	-	(6.93)
Merger expenses of RREL	(0.87)	0.37	-	(0.50)
Re-measurement of post employment benefits obligation	(6.56)	0.33	(1.14)	(7.37)
Net Deferred tax liabilities	131.04	(1.00)	18.63	148.67

(₹ in millions)

C: The major components of deferred tax liabilities/(assets) arising on account of timing differences are as follows:	As at 01 April 2022	Recognized in Profit and Loss	Recognized in Other Comprehensive Income	As at 30 June 2022
Deferred tax liabilities				
Difference between written down value as per books of account and Income Tax Act, 1961.	167.05	(1.82)	-	165.23
Difference in carrying value and tax base of investments in equity measured at FVTOCI	50.42		(5.40)	45.02
Difference in carrying value and tax base of investments in Mutual Fund	27.69	(7.27)	-	20.42
Mark to market exchange gain and loss	0.16	5.03	-	5.19
Deferred tax assets				
Provision for expenses allowed for tax purpose on payment basis (net)	(15.93)	3.81	-	(12.12)
Allowance for expected credit loss on trade receivable	(86.08)	0.40	-	(85.68)
Provision for advance given to supplier	(3.93)	(1.15)	-	(5.08)
Rou assets and Lease liabilities	(0.91)	1.77	-	0.86
Merger expenses of RREL	(0.87)	(0.11)	-	(0.98)
Re-measurement of post employment benefits obligation	(6.56)	-	(0.46)	(7.02)
Net Deferred tax liabilities	131.04	0.66	(5.86)	125.84

R R KABEL LIMITED
Annexure VI - Notes to Restated Consolidated Financial Information

(₹ in millions)

The major components of deferred tax liabilities/(assets) arising on account of timing differences are as follows:	As at 01 April 2021	Recognized in Profit and Loss	Recognized in Other Comprehensive Income	As at 31 March 2022
Deferred tax liabilities				
Difference between written down value as per books of account and Income Tax Act, 1961.	169.31	(2.26)	-	167.05
Difference in carrying value and tax base of investments in equity measured at FVTOCI	25.60	23.79	1.03	50.42
Difference in carrying value and tax base of investments in Mutual Fund	12.76	14.93	-	27.69
Deferred tax assets				
Provision for expenses allowed for tax purpose on payment basis (net)	(12.08)	(3.85)	-	(15.93)
Allowance for expected credit loss on trade receivable	(90.63)	4.55	-	(86.08)
Mark to market exchange gain and loss	0.16	-	-	0.16
Provision for advance given to supplier	(14.30)	10.37	-	(3.93)
Provision for warranty	(5.46)	5.46	-	-
Rou assets and Lease liabilities	(0.46)	(0.45)	-	(0.91)
Merger expenses of RREL	(1.29)	0.42	-	(0.87)
Re-measurement of post employment benefits obligation	(4.74)	-	(1.82)	(6.56)
Net deferred tax liabilities	78.87	52.96	(0.79)	131.04

(₹ in millions)

The major components of deferred tax liabilities/(assets) arising on account of timing differences are as follows:	As at 01 April 2020	Recognized in Profit and Loss	Recognized in Other Comprehensive Income	As at 31 March 2021
Deferred tax liabilities				
Difference between written down value as per books of account and Income Tax Act, 1961.	169.17	0.14	-	169.31
Difference in carrying value and tax base of investments in equity measured at FVTOCI	18.61	-	6.99	25.60
Difference in carrying value and tax base of investments in Mutual Fund	5.57	7.19	-	12.76
Deferred tax assets				
Provision for expenses allowed for tax purpose on payment basis (net)	(12.58)	0.50	-	(12.08)
Allowance for expected credit loss on trade receivable	(77.31)	(13.32)	-	(90.63)
Mark to market exchange gain and loss	(3.50)	3.66	-	0.16
Provision for advance given to supplier	-	(14.30)	-	(14.30)
Provision for warranty	-	(5.46)	-	(5.46)
Rou assets and Lease liabilities	(0.32)	(0.14)	-	(0.46)
Merger expenses of RREL	(0.39)	(0.90)	-	(1.29)
Disallowance under sec 40(a)(ia)	(0.01)	0.01	-	-
Preliminary expenditure	(1.75)	1.75	-	-
Re-measurement of post employment benefits obligation	(5.76)	-	1.02	(4.74)
Net deferred tax liabilities	91.73	(20.87)	8.01	78.87

R R KABEL LIMITED
Annexure VI - Notes to Restated Consolidated Financial Information

(₹ in millions)

Note 18A: OTHER LIABILITIES	Non-Current				
	As at 30 June 2023	As at 30 June 2022	As at 31 March 2023	As at 31 March 2022	As at 31 March 2021
Deferred income (Note 18.1)	0.08	0.13	0.09	0.09	0.18
	0.08	0.13	0.09	0.09	0.18

(₹ in millions)

Note 18B: OTHER LIABILITIES	Current				
	As at 30 June 2023	As at 30 June 2022	As at 31 March 2023	As at 31 March 2022	As at 31 March 2021
Advances from customers	598.38	548.48	705.00	255.21	43.73
Deferred income (Note 18.1)	13.77	10.22	13.77	11.23	37.26
Statutory dues					
Value added tax	2.31	6.06	4.01	6.06	-
Provident fund and professional tax	16.44	16.21	16.12	11.13	9.25
TDS / TCS payable	48.10	38.93	9.72	41.05	25.75
Goods and services tax	45.06	4.69	149.70	70.30	4.43
Export incentives & duty scripts	1.22	19.30	60.40	20.47	-
	725.28	643.89	958.72	415.45	120.42

Note: 18.1 Deferred income mainly represents grants relating to property, plant and equipment and duty saved on import of capital goods and spares under the EPCG scheme. Under such scheme, the Company is committed to export prescribed times of the duty saved on import of capital goods over a specified period of time. In case such commitments are not met, the Company would be required to pay the duty saved along with interest to the regulatory authorities.

(₹ in millions)

Note 19: TRADE PAYABLES	As at 30 June 2023	As at 30 June 2022	As at 31 March 2023	As at 31 March 2022	As at 31 March 2021
Trade payables					
- total outstanding dues of micro enterprises and small enterprises (Note 30)	308.29	161.01	458.81	110.99	93.22
- total outstanding dues of creditors other than micro enterprises and small enterprises	4,218.88	3,643.79	3,942.48	1,567.75	1,041.81
	4,527.17	3,804.80	4,401.29	1,678.74	1,135.03

Note 19.1 "Includes acceptances amount of ₹ 1,918.22 (for period ended 30 June 22 ₹ 1,062.81 millions, for years ended 31 March 23 ₹ 1,402.99 millions) paid to suppliers through usance letter of credit issued by the bank under non - fund based working capital limits to the company. The arrangements are interest bearing. Non-fund limits are secured by first pari passu charge over the present and future current assets of the Company. The company continues to recognize those liabilities till the settlement with the banks which are normally effected with in a period of 60 days."

R R KABEL LIMITED
Annexure VI - Notes to Restated Consolidated Financial Information

Trade Payables ageing schedule as at 30 June 2023

(₹ in millions)

Particulars	Outstanding for following periods from transaction date of the payment					As at 30 June 2023
	Unbilled	Less than 1 Year	1-2 Years	2-3 years	More than 3 years	Total
Undisputed- micro enterprises and small enterprises	-	308.23	0.06	-	-	308.29
Undisputed- Others	689.95	3,510.91	14.85	0.78	2.39	4,218.88
Total	689.95	3,819.14	14.91	0.78	2.39	4,527.17

Trade Payables ageing schedule as at 30 June 2022

(₹ in millions)

Particulars	Outstanding for following periods from transaction date of the payment					As at 30 June 2022
	Unbilled	Less than 1 Year	1-2 Years	2-3 years	More than 3 years	Total
Undisputed- micro enterprises and small enterprises	-	160.80	0.02	-	0.19	161.01
Undisputed- Others	434.09	3,200.34	3.63	1.71	4.02	3,643.79
Total	434.09	3,361.14	3.65	1.71	4.21	3,804.80

Trade Payables ageing schedule as at 31 March 2023

(₹ in millions)

Particulars	Outstanding for following periods from transaction date of the payment					As at 31 March 2023
	Unbilled	Less than 1 Year	1-2 Years	2-3 years	More than 3 years	Total
Undisputed- micro enterprises and small enterprises	-	458.23	0.39	0.19	-	458.81
Undisputed- Others	416.11	3,486.21	37.38	0.11	2.67	3,942.48
Total	416.11	3,944.44	37.77	0.30	2.67	4,401.29

Trade Payables ageing schedule as at 31 March 2022

(₹ in millions)

Particulars	Outstanding for following periods from transaction date of the payment					As at 31 March 2022
	Unbilled	Less than 1 Year	1-2 Years	2-3 years	More than 3 years	Total
Undisputed- micro enterprises and small enterprises	-	110.99	-	-	-	110.99
Undisputed- Others	258.48	1,298.89	3.35	3.57	3.46	1,567.75
Total	258.48	1,409.88	3.35	3.57	3.46	1,678.74

Trade Payables ageing schedule as at 31 March 2021

(₹ in millions)

Particulars	Outstanding for following periods from transaction date of the payment					As at 31 March 2021
	Unbilled	Less than 1 Year	1-2 Years	2-3 years	More than 3 years	Total
Undisputed- micro enterprises and small enterprises	-	93.20	0.02	-	-	93.22
Undisputed- Others	104.44	926.35	3.52	3.39	4.11	1,041.81
Total	104.44	1,019.55	3.54	3.39	4.11	1,135.03

R R KABEL LIMITED
Annexure VI - Notes to Restated Consolidated Financial Information

(₹ in millions)

Note 20: INCOME TAX LIABILITIES (NET)	As at 30 June 2023	As at 30 June 2022	As at 31 March 2023	As at 31 March 2022	As at 31 March 2021
Provision for income tax (net of advance tax)	229.54	-	64.34	-	-
	229.54	-	64.34	-	-

(₹ in millions)

Note 21: REVENUE FROM OPERATIONS	For the period ended 30 June 2023	For the period ended 30 June 2022	For the year ended 31 March 2023	For the year ended 31 March 2022	For the year ended 31 March 2021
Revenue from contract with customers (Note 44)					
Sales of products					
Finished goods (Note 27.1)	14,522.83	11,187.90	51,046.87	41,082.03	25,210.70
Traded goods	1,282.22	1,007.04	4,322.02	2,110.99	1,522.61
	15,805.05	12,194.94	55,368.89	43,193.02	26,733.31
Other operating revenues :					
Sale of scrap	166.64	159.05	616.35	663.80	442.13
Processing charges	1.45	0.83	2.34	2.54	2.17
Export incentives	-	4.28	4.42	-	61.80
	168.09	164.16	623.11	666.34	506.10
	15,973.14	12,359.10	55,992.00	43,859.36	27,239.41

(₹ in millions)

Note 22: OTHER INCOME	For the period ended 30 June 2023	For the period ended 30 June 2022	For the year ended 31 March 2023	For the year ended 31 March 2022	For the year ended 31 March 2021
Interest Income:					
Bank deposits	6.86	0.30	17.34	4.04	21.44
Others (Note 21.1)	1.55	2.97	13.38	5.63	11.45
Dividends from quoted equity investments	-	-	7.06	1.41	0.71
Fair value gain on investment on mutual fund	38.47	12.04	104.34	94.53	40.02
Other Non Operating Income:					
Rent income	0.84	0.73	2.89	2.94	2.91
Guarantee commission	-	-	-	13.04	5.88
Foreign exchange gain (net)	102.72	28.16	140.86	265.09	103.53
Grant related to property, plant and equipment	0.01	0.97	1.01	36.92	0.04
Grant related to electricity	3.62	-	25.91	-	-
Gain on sale of property plant and equipment (net)	-	0.15	0.80	20.28	0.87
Gain on sale of mutual fund investments	7.67	0.41	8.70	0.04	32.07
Bad debts recovered	-	-	-	-	0.03
Reversal of Expected credit Loss provision on trade receivable (net)	-	8.91	-	18.07	-
Reversal of provision on advances to vendor	-	19.26	19.26	-	-
Miscellaneous income	1.10	-	2.85	0.83	1.00
	162.84	73.90	344.40	462.82	219.95

Note 22.1: Others include interest from customers

(₹ in millions)

Note 23A: COST OF MATERIALS CONSUMED	For the period ended 30 June 2023	For the period ended 30 June 2022	For the year ended 31 March 2023	For the year ended 31 March 2022	For the year ended 31 March 2021
Inventories at the beginning of the year	873.07	1,340.55	1,340.55	844.36	801.17
Add :Purchases of inventories from business acquisition (Note 51)	-	61.41	61.41	-	-
Add :Purchases	12,104.05	10,729.76	43,168.99	36,251.34	21,775.18
	12,977.12	12,131.72	44,570.95	37,095.70	22,576.35
Less :Inventories at the end of the year	1,005.99	1,730.42	873.07	1,340.55	844.36
	11,971.13	10,401.30	43,697.88	35,755.15	21,731.99

R R KABEL LIMITED
Annexure VI - Notes to Restated Consolidated Financial Information

(₹ in millions)

Note 23B: PURCHASES OF STOCK - IN -TRADE	For the period ended 30 June 2023	For the period ended 30 June 2022	For the year ended 31 March 2023	For the year ended 31 March 2022	For the year ended 31 March 2021
Electrical appliances (Note 27.1)	923.35	693.84	3,417.99	1,566.17	1,298.64
Electrical appliances purchase on account of business acquisition (Note 51)	-	270.54	270.54	-	-
	923.35	964.38	3,688.53	1,566.17	1,298.64

(₹ in millions)

Note 23C: CHANGES IN INVENTORIES OF FINISHED GOODS, STOCK-IN-TRADE, WORK-IN-PROGRESS AND SCRAP	For the period ended 30 June 2023	For the period ended 30 June 2022	For the year ended 31 March 2023	For the year ended 31 March 2022	For the year ended 31 March 2021
Inventories at the end of the year:					
Finished goods	5,514.63	5,198.47	5,595.84	4,182.35	3,176.51
Work-in-progress	1,467.57	1,235.78	1,489.33	1,194.57	988.29
Stock-in-trade	477.52	526.09	555.00	298.25	266.02
Scrap	38.70	10.46	19.08	15.50	18.35
	7,498.42	6,970.80	7,659.25	5,690.67	4,449.17
Less: Inventories at the beginning of the year					
Finished goods	5,595.84	4,182.35	4,182.35	3,176.51	1,606.96
Work-in-progress	1,489.33	1,194.57	1,194.57	988.29	949.18
Stock-in-trade	555.00	298.25	298.25	266.02	346.39
Scrap	19.08	15.50	15.50	18.35	8.19
	7,659.25	5,690.67	5,690.67	4,449.17	2,910.72
Add: Inventories purchase on account of business acquisition (Note 51)					
Finished goods	-	330.22	330.22	-	-
Work-in-progress	-	8.96	8.96	-	-
	-	339.18	339.18	-	-
	160.83	(940.95)	(1,629.40)	(1,241.50)	(1,538.45)

(₹ in millions)

Note 24: EMPLOYEE BENEFITS EXPENSE	For the period ended 30 June 2023	For the period ended 30 June 2022	For the year ended 31 March 2023	For the year ended 31 March 2022	For the year ended 31 March 2021
Salaries, wages and incentives	656.53	525.17	2,233.19	1,561.77	1,237.13
Remuneration to directors*	22.48	21.51	95.21	103.45	78.03
Employees share based payment expenses(Note 48)	3.18	2.86	5.04	7.52	-
Contributions to:					
Provident fund and ESIC (Note 35B)	24.03	19.53	87.20	61.09	49.38
Gratuity fund (Note 35A)	7.29	6.91	28.08	20.65	20.90
Compensated absences	22.74	8.63	71.73	46.89	41.08
Staff welfare expenses	31.44	27.14	121.14	87.16	56.93
	767.69	611.75	2,641.59	1,888.53	1,483.45

* Including commission given to directors ₹ 9.84 millions, (period ended 30 June 2022 ₹ 2.59 millions, 31 March 2023 ₹ 26.40 millions, 31 March 2022 ₹ 27.23 millions and 31 March 2021 ₹ 19.23 millions)

R R KABEL LIMITED
Annexure VI - Notes to Restated Consolidated Financial Information

(₹ in millions)

Note 25: FINANCE COSTS	For the period ended 30 June 2023	For the period ended 30 June 2022	For the year ended 31 March 2023	For the year ended 31 March 2022	For the year ended 31 March 2021
Interest on financial liabilities carried at amortised cost					
Interest on borrowings	125.59	74.92	354.51	220.83	260.92
Interest on lease liabilities	13.32	2.38	41.02	3.10	3.11
Other borrowing costs	5.33	3.42	16.60	3.61	5.73
Net exchange difference regarded as adjustment to borrowing cost	-	-	-	5.19	0.68
Interest on income tax	-	0.05	8.73	0.11	0.12
	144.24	80.77	420.86	232.84	270.56

Note :The amount of “other borrowing cost” under schedule of finance cost was shown as single line item in the Consolidated Financial Statements for the years ended 31 March 2021. However, Interest on lease liabilities have now been disaggregated from other borrowing costs to align with presentation in the Consolidated Financial Statements for the year ended 31 March 2022. (refer note B (3) in Annexure VII)

(₹ in millions)

Note 26: DEPRECIATION AND AMORTISATION EXPENSE	For the period ended 30 June 2023	For the period ended 30 June 2022	For the year ended 31 March 2023	For the year ended 31 March 2022	For the year ended 31 March 2021
Depreciation of property, plant and equipment (Note 2A)	120.84	105.95	461.14	404.21	398.95
Amortisation of other intangible assets (Note 2D)	10.60	9.43	41.65	18.03	18.08
Amortisation of right-of-use assets (Note 2C)	29.43	29.44	93.48	38.60	30.47
	160.87	144.82	596.27	460.84	447.50

(₹ in millions)

Note 27: OTHER EXPENSES	For the period ended 30 June 2023	For the period ended 30 June 2022	For the year ended 31 March 2023	For the year ended 31 March 2022	For the year ended 31 March 2021
Rent expenses (Note 40)	5.64	4.76	13.32	15.52	9.52
Rates and taxes	3.65	10.10	16.09	17.39	21.82
Repairs and Maintenance of :					
Buildings	1.18	3.82	13.07	27.67	8.25
Plant and machinery	23.83	33.62	181.63	132.25	106.19
Others	8.76	8.63	45.37	19.12	16.67
Commission on sales	61.81	58.26	255.33	157.44	105.42
Advertisement and business promotion expenses (Note 27.3)	188.15	134.45	851.43	491.29	259.61
Travelling expenses	47.59	46.35	207.04	83.50	41.62
Payment to auditors (Note 29)	1.89	1.89	7.89	5.91	5.73
Legal and professional fees	27.82	48.51	260.55	162.95	109.45
Insurance charges	12.20	10.03	50.56	35.57	23.63
Allowance for expected credit loss on trade receivables(net)	2.90	-	5.39	-	52.91
Bad debts	0.23	1.60	3.75	10.60	-
Bank charges	3.22	3.34	7.24	9.65	20.53
Consumption of consumable stores and spares	17.44	12.73	80.21	31.73	18.03
Corporate social responsibility expenses (Note 32)	-	0.40	40.40	33.03	32.77
Donation	1.60	1.13	9.38	17.42	17.65
Director sitting fees and commission-independent directors (Note 27.2 & Note 33)	2.36	0.36	7.30	2.21	2.35
Freight and distribution charges	307.10	289.33	1,155.78	820.20	489.72
Power and fuel	141.91	109.05	487.93	370.24	306.62
Research and development expenses (Note 41)	5.97	4.72	21.58	41.86	20.94
Warranty expenses (Note 27.1)	40.18	59.96	163.75	148.18	83.66
Miscellaneous expenses	115.22	79.83	485.21	224.80	209.22
	1,020.65	922.87	4,370.20	2,858.53	1,962.31

R R KABEL LIMITED
Annexure VI - Notes to Restated Consolidated Financial Information

Note 27.1 : Warranty expenses were netted off against revenue and purchase of stock in trade respectively which is now restated in the warranty expenses under other expenses. (refer note B (3) in Annexure VII)

(₹ in millions)

Particulars	Year Ended 31 March 2021		
	As per earlier reported	Revised classification	Restatement adjustment
Revenue			
Sale of products	26,653.32	26,733.31	79.99
Expenses			
Purchase of traded goods	1,280.64	1,298.64	18.00
Other expenses	1,900.32	1,962.31	61.99
Total			-

Note 27.2 :

“Director sitting fees” was grouped in miscellaneous expenses and “Commission to independent directors” was grouped in Legal and professional expenses in the Consolidated Financial Statement for the years ended 31 March 2021. The same are now re-grouped in a separate line item to align with presentation in the Consolidated Financial Statements for the year ended 31 March 2022 as under. (refer note B (3) in Annexure VII)

(₹ in millions)

Particulars	Year Ended 31 March 2021		
	As per earlier reported	Revised classification	Restatement adjustment
Legal and professional fees	110.64	109.44	(1.20)
Director sitting fees and commission-independent directors	-	2.35	2.35
Miscellaneous expenses	210.37	209.22	(1.15)
Total	321.01	321.01	-

Note 27.3 :

The details of advertisement expenses and business promotion expenses is as under:

(₹ in millions)

Particulars	For the period ended 30 June 2023	For the period ended 30 June 2022	For the year ended 31 March 2023	For the year ended 31 March 2022	For the year ended 31 March 2021
Advertisement expenses	133.10	82.87	541.68	386.99	212.42
Business promotion expenses	55.05	51.58	309.75	104.30	47.19
Total	188.15	134.45	851.43	491.29	259.61

(₹ in millions)

Note 28 : Contingent Liabilities and Commitments	As at 30 June 2023	As at 30 June 2022	As at 31 March 2023	As at 31 March 2022	As at 31 March 2021
Contingent Liabilities					
A) Claims against the Company not acknowledged as debts					
Service tax and GST demands (Note 28.1)	39.20	37.54	37.54	21.22	20.93
Income tax demands (Note 28.1)	31.71	31.71	31.71	21.96	23.10
Sales tax / Vat demands -C Forms (Note 28.1)	96.73	96.73	96.73	95.35	99.86
Labour law demand (Note 28.1)	1.91	1.73	1.86	1.56	1.24
B) Channel financing guarantees (Note 28.2)	225.00	225.00	225.00	425.76	546.00
Commitments					
A) Estimated amount of contracts remaining to be executed and not provided for:					
- On Capital Account (net of advance)	834.78	242.76	718.98	215.31	266.09

28.1 : Future cash outflows in respect of the above, if any, is determinable only on receipt of judgement/decisions pending with the relevant authorities. The Company does not expect the outcome of the matters stated above to have a material adverse impact on the Company's financial condition, results of operations or cash flows.

28.2 : The Company has arranged Channel Finance facility for its customers from banks against which sum of ₹ 2,697.80 millions, (period ended 30 June 22 ₹ 1,758.26 millions, 31 March 2023 ₹ 2,557.76 millions, 31 March 2022 ₹ 1,704.37 millions, 31 March 2021 ₹ 1,085.54 millions) has been utilised as on the date of balance sheet. Accordingly, the contingency on company on account of customers defaulting in repayment to the respective banks is ₹ 225.00 millions (period ended 30 June 2022 ₹ 225.00 millions, 31 March 2023 ₹ 225.00 millions, 31 March 2022 ₹ 425.76 millions, 31 March 2021 ₹ 546.00 millions) (to the extent of recourse available with bank).

R R KABEL LIMITED
Annexure VI - Notes to Restated Consolidated Financial Information

28.3 : The Honourable Supreme Court of India vide its order dated 28 February, 2019 held that 'Basic Wages' for the contribution towards Provident Fund (PF) should only exclude [in addition to specific exclusions under Section 2(b)(ii) of the Employees Provident Fund Act, 1952]:

- amounts that are payable to the employee for undertaking work beyond the normal work which he/she is otherwise required to put in and
- allowances which are either variable or linked to any incentive for production resulting in greater output by an employee and that the allowances are not paid across the board to all employees in a particular category or were being paid especially to those who avail the opportunity.

For the period prior to 28 February, 2019 with reference to the above mentioned judgment, the Company's Management is of the view that there is considerable uncertainty around the timing, manner and extent in which the judgment will be interpreted and applied by the regulatory authorities. Management is of the view that any incremental outflow in this regard can only be determined once the position being taken by the regulatory authorities in this regard is known and the Management is able to evaluate all possible courses of action available. Accordingly, no provision has been currently recognized in the Restated Consolidated Financial Information in this regard. For the period subsequent to 28 February, 2019 upto 31 January, 2021 the impact of the above judgement is not significant and hence no provision has been recognised in the Financial Statement in this regard. Company has implemented the impact of the above change in definition of basic wages effective from 1 Feb 2021. Hence, it will not have any impact on period ended 30 June 2023, 30 June 2022 and years ended 31 March 2023, 31 March 2022 and 31 March 2021.

(₹ in millions)

Note 29 : Payment to Auditors	For the period ended 30 June 2023	For the period ended 30 June 2022	For the year ended 31 March 2023	For the year ended 31 March 2022	For the year ended 31 March 2021
Payment to auditors :					
a) As auditors	1.80	1.80	7.20	5.50	5.50
b) For certifications services	-	-	0.08	0.22	0.08
C) For expenses reimbursement	0.09	0.09	0.61	0.19	0.15
	1.89	1.89	7.89	5.91	5.73

(₹ in millions)

Note 30 : Disclosure required under Section 22 of the Micro, Small and Medium Enterprises Development Act, 2006	For the period ended 30 June 2023	For the period ended 30 June 2022	For the year ended 31 March 2023	For the year ended 31 March 2022	For the year ended 31 March 2021
(a) Principal amount and the interest due thereon remaining unpaid to any suppliers at the end of the each accounting year :					
Principal	323.83	181.76	503.05	117.27	93.22
Interest	1.10	0.45	1.38	0.47	0.12
(b) (i) The delayed payment of principal amount paid beyond the appointed day the year.	391.88	128.56	1,416.27	1,818.23	387.36
(ii) Interest actually paid under Section 16 of the MSMED Act, 2006	-	-	-	0.02	0.02
(c) The amount of interest due and payable for the period of delay in making payment(which have been paid but beyond appointed date during the year) but without adding the interest specified under the MSMED Act, 2006	2.83	0.53	12.13	3.63	1.68
(d) The amount of interest accrued and remaining unpaid at the end of each accounting year	23.75	7.29	19.82	6.31	2.23
(e) The amount of further interest remaining due and payable even in the succeeding years, until such date when the interest dues above are actually paid to the small enterprise, for the purpose of disallowance of a deductible expenditure under Section 23 of the Micro, Small and Medium Enterprises Development Act, 2006.	-	-	-	-	-

Dues to Micro, Small and Medium Enterprises have been determined to the extent such parties have been identified on the basis of information collected by the Management.

R R KABEL LIMITED
Annexure VI - Notes to Restated Consolidated Financial Information

(₹ in millions)

Note 31 : Dividend	For the period ended 30 June 2023	For the period ended 30 June 2022	For the year ended 31 March 2023	For the year ended 31 March 2022	For the year ended 31 March 2021
Final Dividend paid ₹ 00.00 (period ended 30 June 2022 ₹ 00.00 year ended 31 March 2023 ₹ 18.00 year ended 31 March 2022 ₹ 10.00 period ended 31 March 2021 ₹ 0.00) per equity share of ₹ 10.00 each	-	-	430.63	239.24	-
Final Dividend paid ₹ 00.00 (period ended 30 June 2022 ₹ 00.00, year ended 31 March 2023 ₹ 18.00, year ended 31 March 2022 ₹ 10.00 period ended 31 March 2021 ₹ 0.00) per Compulsory Convertible Preference Share of ₹ 1,080.33 each	-	-	69.18	38.43	-
Total	-	-	499.81	277.67	-

31.1 Dividend proposed of ₹ 4.5 each amounting to ₹ 430.63 millions for period ended March 23 (for year ended March 22 ₹ 18 each amounting to ₹ 430.63 millions and for year ended March 21 ₹ 10 each amounting to ₹ 239.24 millions) by board of directors on 14 August 2023 per equity share before the financial statements approved for issue but not recognized as a Liability in financial statements.

31.1 Dividend proposed of ₹ 18 each amounting to ₹ 69.18 millions for period ended March 23 (for year ended March 22 ₹ 18 each amounting to ₹ 69.18 millions and for year ended March 21 ₹ 10 each amounting to ₹ 38.43 millions) by board of directors on 14 August 2023 per Compulsory Convertible Preference Share before the financial statements approved for issue but not recognized as a Liability in financial statements.

Note 32 : Expenditure on Corporate Social Responsibility initiatives

(₹ in millions)

Particulars	For the period ended 30 June 2023	For the period ended 30 June 2022	For the year ended 31 March 2023	For the year ended 31 March 2022	For the year ended 31 March 2021
Corporate Social Responsibility expenses for the period/ year	-	0.40	40.40	33.03	32.77
Various Head of expenses included in above:					
Promoting education	-	0.40	40.30	29.18	31.97
Rural development	-	-	0.10	2.93	-
Women empowerment	-	-	-	0.50	-
Promoting health care including preventive health care	-	-	-	0.42	0.74
Conservation of natural resources	-	-	-	-	0.06
Gross amount required to be spent by the company during the year.	45.10	40.37	40.37	32.67	33.09
Amount spent during the period/year on:	-	0.40	40.40	33.03	32.77
(i) Construction/acquisition of any asset	-	-	-	-	-
(ii) On purposes other than (i) above	-	0.40	40.40	33.03	32.77
Details of related party transactions	-	-	-	-	-
<u>Provision for CSR Expenses related to ongoing projects</u>					
Opening Balance	-	-	-	3.47	-
Add: Provision created during the period/year	-	-	-	-	9.40
Less: Provision utilised during the period/year	-	-	-	3.47	5.93
Closing Balance	-	-	-	-	3.47
The amount of shortfall at the end of the period/ year out of the amount required to be spent by the Company during the period/year.	Not applicable	Not applicable	-	-	0.33
The total of previous years' shortfall amounts	-	-	-	-	-

Note 33: Related party disclosures as required under Ind AS- 24 are given below :

Relationships

a) Key management Personnel:

Tribhuvanprasad Rameshwarlal Kabra	Executive Chairman
Shreegopal Rameshwarlal Kabra	Managing Director
Mahendrakumar Rameshwarlal Kabra	Joint Managing Director
Ashok Satyanarayan Loya (upto 20.09.2022)	Whole Time Director
Mahhesh Kabra (upto 16.12.2022)	Whole Time Director
Sumeet Mahendrakumar Kabra (upto 16.12.2022)	Whole Time Director
Kirtidevi Shreegopal Kabra (upto 16.12.2022)	Whole Time Director
Sanjay Narnarayan Taparia (upto 16.12.2022)	Whole Time Director
Rajesh Babu Jain (upto 16.12.2022)	Whole Time Director
Partha Chakraborti (upto 31.03.2021)	Chief Financial Officer
Rajeev Pandiya (w.e.f 01.04.2021 upto 22.08.2022)	Chief Financial Officer
Rajesh Babu Jain (w.e.f. 23.08.2022)	Chief Financial Officer
Dinesh Aggarwal (w.e.f. 16.12.2022)	Chief Executive Officer
Himanshu Navinchandra Parmar	Company Secretary

Non-Executive directors

Ramamirtham Kannan (upto 16.12.2022)	Independent Director
Bhagwat Singh Babel	Independent Director
Mukund Chitale (upto 29.04.2023)	Independent Director
Puneet Bhatia (upto 16.12.2022)	Non-Executive Nominee Director
Mitesh Daga	Non-Executive Nominee Director
Vipul Sabharwal (w.e.f. 23.08.2022)	Independent Director
Jyoti Davar (w.e.f. 16.12.2022)	Independent Director
Ramesh Chandak (w.e.f. 29.04.2023)	Independent Director

b) Relatives of Key management Personnel:

Rameshwarlal Jagannath Kabra	Father of Tribhuvanprasad Rameshwarlal Kabra, Mahendrakumar Rameshwarlal Kabra and Shreegopal Rameshwarlal Kabra
Ratnidevi Rameshwarlal Kabra	Mother of Tribhuvanprasad Rameshwarlal Kabra, Mahendrakumar Rameshwarlal Kabra and Shreegopal Rameshwarlal Kabra
Satyanarayan Loya	Father of Ashok Satyanarayan Loya
Saraswatidevi Satyanarayan Loya	Mother of Ashok Satyanarayan Loya
Hemant Mahendrakumar Kabra	Son of Mahendrakumar Rameshwarlal Kabra
Umadevi Tribhuvanprasad Kabra	Wife of Tribhuvanprasad Rameshwarlal Kabra
Vvidhi Kabra	Wife of Mahhesh Kabra
Anant Satyanarayan Loya	Brother of Ashok Satyanarayan Loya
Neha Ashok Loya	Daughter of Ashok Satyanarayan Loya
Mamta Ashok Loya	Wife of Ashok Satyanarayan Loya
Nikunj Ashok Loya	Son of Ashok Satyanarayan Loya
Kishori Dinesh Modani	Sister of Kirtidevi Shreegopal Kabra
Shaurya Sanjay Taparia	Son of Sanjay Narnarayan Taparia
Vandana Jain	Wife of Rajesh Babu Jain
Sarita Jhawar	Daughter of Tribhuvanprasad Rameshwarlal Kabra
Rajesh Shreegopal Kabra	Son of Shreegopal Rameshwarlal Kabra
Gaurishankar Satyanarayan Loya	Brother of Ashok Satyanarayan Loya
Priti Amit Saboo	Daughter of Shreegopal Rameshwarlal Kabra
Shruti Kalani	Daughter of Sanjay Narnarayan Taparia
Asha Muchhal	Daughter of Shreegopal Kabra
Janvi Kabra	Daughter of Mahhesh Kabra
Deves Kabra	Son of Mahhesh Kabra
Saumya Sumeet Kabra	Daughter of Sumeet Mahendrakumar Kabra
Samaya Sumeet Kabra	Daughter of Sumeet Mahendrakumar Kabra

C) Entities over which Key Management Personnel and their relatives are able to exercise significant influence:

MEW Electricals Limited	Rameshwarlal Kabra (HUF)
Ram Ratna International	Tribhuvanprasad Kabra (HUF)
Kabel Buildcon Solutions Private Limited	Mahendra Kumar Kabra (HUF)
Ram Ratna Infrastructure Private Limited	Kabra Shreegopal Rameshwarlal (HUF)
Ram Ratna Wires Limited	Mahesh Kabra (HUF)
Pratik Wire & Cable Machine Private Limited	Satyanarayan Mohanlal Loya (HUF)
Jag-Bid Finvest Private Limited	Anant Satyanarayan Loya (HUF)
RR Electrical Middle East FZC	
Ram Ratna Research and Holdings Private Limited	
Global Copper Private Limited	
KGR Worldwide Solutions LLP	
Epavo Electricals Private Limited	
Maa Ratnidevi Kabra Maheshwari Mahila Sashaktikaran Trust	

D) Joint venture:

RR-Imperial Electricals Limited

R R KABEL LIMITED
Annexure VI - Notes to Restated Consolidated Financial Information

Transactions with the related parties in the ordinary course of business:

A) Transactions with Key Management Personnel:

(₹ in millions)

Particulars	For the period ended 30 June 2023	For the period ended 30 June 2022	For the year ended 31 March 2023	For the year ended 31 March 2022	For the year ended 31 March 2021
Expenses:					
Interest on borrowings					
Sumeet Mahendrakumar Kabra	-	-	-	-	4.19
Mahendrakumar Rameshwarlal Kabra	-	-	-	-	3.52
Kirtidevi Shreegopal Kabra	-	-	-	-	1.08
Others	-	-	-	-	1.68
Rent expenses					
Mahhesh Kabra	-	-	-	-	0.04
Mahendrakumar Rameshwarlal Kabra	-	-	-	-	0.07
Directors :					
Director sitting fees					
Bhagwat Singh Babel	0.32	0.14	0.82	0.41	0.47
Ramamirtham Kannan	-	0.11	0.41	0.35	0.41
Mahendrakumar Rameshwarlal Kabra	0.20	-	0.28	0.10	0.20
Mukund Chitale	0.19	0.11	0.49	0.25	0.27
Vipul Sabharawal	0.32	-	0.34	-	-
Jyoti Davar	0.15	-	0.15	-	-
Ramesh Deokishandas Chandak	0.18	-	-	-	-
Commission-independent directors					
Bhagwat Singh Babel	0.25	-	1.40	0.40	0.40
Ramamirtham Kannan	-	-	1.11	0.40	0.40
Mukund Chitale	0.08	-	1.40	0.40	0.40
Vipul Sabharawal	0.25	-	0.61	-	-
Jyoti Davar	0.25	-	0.29	-	-
Ramesh Deokishandas Chandak	0.17	-	-	-	-
Commission to directors					
Tribhuvanprasad Rameshwarlal Kabra	4.94	1.28	13.20	13.62	9.61
Shreegopal Rameshwarlal Kabra	4.94	1.28	13.20	13.62	9.61

R R KABEL LIMITED
Annexure VI - Notes to Restated Consolidated Financial Information

(₹ in millions)

Particulars	For the period ended 30 June 2023	For the period ended 30 June 2022	For the year ended 31 March 2023	For the year ended 31 March 2022	For the year ended 31 March 2021
Managerial Remuneration (Note 33.1)					
Ashok Satyanarayan Loya	-	1.50	3.00	6.00	4.75
Kirtidevi Shreegopal Kabra	-	1.80	5.11	7.20	5.70
Sanjay Narnarayan Taparia	-	2.25	8.52	9.00	6.00
Shreegopal Rameshwarlal Kabra	6.30	3.60	17.10	14.40	11.40
Sumeet Mahendrakumar Kabra	-	1.80	5.11	7.20	5.70
Tribhuvanprasad Rameshwarlal Kabra	6.30	3.60	17.10	14.40	11.40
Mahhesh Kabra	-	1.80	5.11	7.20	5.70
Rajesh Babu Jain	3.38	2.64	11.70	10.22	7.83
Partha Chakraborti	-	-	-	-	16.12
Rajeev Pandiya	-	10.23	17.27	17.28	-
Dinesh Aggarwal	6.25	-	7.35	-	-
Himanshu Navinchandra Parmar	0.81	0.63	2.65	2.60	1.56
Reimbursement of Travelling expenses					
Tribhuvanprasad Rameshwarlal Kabra	0.49	0.47	2.10	0.99	0.25
Mahendrakumar Rameshwarlal Kabra	-	0.19	0.44	0.27	0.15
Shreegopal Rameshwarlal Kabra	0.49	0.11	0.46	0.39	0.51
Mahhesh Kabra	-	0.12	0.99	0.37	0.18
Kirtidevi Shreegopal Kabra	-	0.06	0.30	0.08	0.05
Others	-	0.08	0.31	0.50	0.10
Dividend Paid:					
Mahendrakumar Rameshwarlal Kabra	-	-	38.92	21.62	-
Shreegopal Rameshwarlal Kabra	-	-	13.47	8.49	-
Kirtidevi Shreegopal Kabra	-	-	25.45	14.14	-
Tribhuvanprasad Rameshwarlal Kabra	-	-	21.97	5.66	-
Mahhesh Kabra	-	-	25.13	5.77	-
Others	-	-	19.65	10.92	-
Borrowings Accepted					
Mahhesh Kabra	-	-	-	-	3.50
Mahendrakumar Rameshwarlal Kabra	-	-	-	-	13.50
Sumeet Mahendrakumar Kabra	-	-	-	-	2.11
Ashok Satyanarayan Loya	-	-	-	-	2.50
Others	-	-	-	-	2.00

R R KABEL LIMITED

Annexure VI - Notes to Restated Consolidated Financial Information

(₹ in millions)

Particulars	For the period ended 30 June 2023	For the period ended 30 June 2022	For the year ended 31 March 2023	For the year ended 31 March 2022	For the year ended 31 March 2021
Borrowings Repaid					
Mahendrakumar Rameshwarlal Kabra	-	-	-	-	79.29
Sumeet Mahendrakumar Kabra	-	-	-	-	95.43
Kirtidevi Shreegopal Kabra	-	-	-	-	24.50
Others	-	-	-	-	38.19
Personal gaurantee outstanding					
For Secured borrowings					
Tribhuvanprasad Rameshwarlal Kabra	4,050.90	4,829.60	5,083.31	4,384.60	5,059.26
Mahendrakumar Rameshwarlal Kabra					
Shreegopal Rameshwarlal Kabra					
Mahhesh Kabra					
Sumeet Mahendrakumar Kabra					
For Un-secured borrowings					
Tribhuvanprasad Rameshwarlal Kabra	2,413.71	1,605.18	1,893.31	1,070.90	330.55
Mahendrakumar Rameshwarlal Kabra					
Shreegopal Rameshwarlal Kabra					
Mahhesh Kabra					
Sumeet Mahendrakumar Kabra					

B) Transactions with Relatives of Key Management Personnel:

(₹ in millions)

Particulars	For the period ended 30 June 2023	For the period ended 30 June 2022	For the year ended 31 March 2023	For the year ended 31 March 2022	For the year ended 31 March 2021
Expenses:					
Interest on borrowings					
Ratnidevi Rameshwarlal Kabra	-	-	-	-	3.36
Rajesh Shreegopal Kabra	-	-	-	-	1.18
Hemant Mahendrakumar Kabra	-	-	-	-	4.84
Others	-	-	-	-	1.81
Rent expenses					
Ratnidevi Rameshwarlal Kabra	1.23	1.18	4.70	4.70	3.98
Umadevi Tribhuvanprasad Kabra	-	-	-	2.27	1.91
Vvidhi Kabra	-	0.57	1.70	-	-
Others	0.13	0.13	0.50	0.46	0.43
Dividend Paid					
Hemant Mahendrakumar Kabra	-	-	30.60	17.00	-
Umadevi Tribhuvanprasad Kabra	-	-	-	32.75	-
Rajesh Shreegopal Kabra	-	-	14.86	8.25	-
Priti Amit Saboo	-	-	12.08	7.71	-
Vvidhi Kabra	-	-	20.03	2.94	-
Sarita Jhavar	-	-	20.21	1.40	-
Others	-	-	23.83	13.24	-
Borrowings Accepted					
Umadevi Tribhuvanprasad Kabra	-	-	-	-	7.50
Hemant Mahendrakumar Kabra	-	-	-	-	6.34
Saumya Sumeet Kabra	-	-	-	-	3.00
Others	-	-	-	-	1.60
Borrowings Repaid					
Hemant Mahendrakumar Kabra	-	-	-	-	109.86
Rajesh Shreegopal Kabra	-	-	-	-	27.04
Ratnidevi Rameshwarlal Kabra	-	-	-	-	74.50
Others	-	-	-	-	44.76
Outstanding balances					
Security deposits Receivable					
Umadevi Tribhuvanprasad Kabra	-	-	-	4.00	4.00
Vvidhi Kabra	-	4.00	-	-	-
Ratnidevi Rameshwarlal Kabra	1.50	1.50	1.50	1.50	1.50
Hemant Mahendrakumar Kabra	0.13	0.13	0.13	0.13	1.05

C) Transactions with the entities over which Key Management Personnel and their relatives are able to exercise significant influence:

(₹ in millions)

Particulars	For the period ended 30 June 2023	For the period ended 30 June 2022	For the year ended 31 March 2023	For the year ended 31 March 2022	For the year ended 31 March 2021
Purchase of Goods					
MEW Electricals Limited	9.88	8.25	27.29	20.55	9.68
Ram Ratna International	-	19.32	22.69	20.42	1.88
Epavo Electricals Private Limited	34.26	8.96	82.27	9.50	-
Others	1.21	0.96	1.87	1.72	0.60
Sale of Goods					
Ram Ratna International	752.05	617.76	1,974.90	1,773.07	977.19
Global Copper Private Limited	2.09	-	63.28	70.18	12.74
Others	22.18	58.18	157.60	202.71	230.85
Purchase of Capital Goods					
Pratik Wire & Cable Machine Private Limited	5.11	0.64	9.04	4.59	7.29
Income :					
Rent income					
Ram Ratna International	-	-	0.04	0.04	0.04
Processing charges					
MEW Electricals Limited	0.32	0.60	1.59	0.36	0.62
Ram Ratna Wires Limited	0.01	0.14	0.47	0.13	-
Expenses:					
Commission on sales					
Ram Ratna International	49.75	35.97	138.17	115.31	66.74
Donations					
Maa Ratnidevi Kabra Maheshwari Mahila Sashaktikaran Trust	-	-	-	10.60	-
Rent expenses					
Kabel Buildcon Solutions Private Limited	-	0.10	0.10	0.87	1.37
Kabra Shreegopal Rameshwarlal (HUF)	1.23	1.18	4.70	4.70	4.00
MEW Electricals Limited	-	-	-	0.28	0.66
Ram Ratna Research and Holdings Private Limited	-	-	-	-	0.02
Interest on borrowings					
Kabra Shreegopal Rameshwarlal (HUF)	-	-	-	-	0.62
Rameshwarlal Kabra (HUF)	-	-	-	-	1.66
Ram Ratna Research and Holdings Private Limited	-	-	-	-	0.78
Mahesh Kabra (HUF)	-	-	-	-	0.27
Mahendra Kumar Kabra (HUF)	-	-	-	-	0.41
Tribhuvanprasad Kabra (HUF)	-	-	-	-	0.41
Jag-Bid Finvest Private Limited	-	-	-	-	0.09

R R KABEL LIMITED
Annexure VI - Notes to Restated Consolidated Financial Information

(₹ in millions)

Particulars	For the period ended 30 June 2023	For the period ended 30 June 2022	For the year ended 31 March 2023	For the year ended 31 March 2022	For the year ended 31 March 2021
Dividend :					
Dividend Paid					
Ram Ratna Research and Holding Private Limited	-	-	22.85	12.70	-
Rameshwarlal Kabra (HUF)	-	-	40.82	22.68	-
Kabra Shreegopal Rameshwarlal (HUF)	-	-	17.65	9.80	-
Tribhuvanprasad Kabra (HUF)	-	-	6.46	3.59	-
Mahendra Kumar Kabra (HUF)	-	-	5.19	2.89	-
Satyanarayan Loya (HUF)	-	-	0.54	0.30	-
Anant Loya (HUF)	-	-	1.17	0.65	-
MEW Electricals Limited	-	-	10.06	5.59	-
Ram Ratna Wires Limited	-	-	6.14	3.41	-
Jag-Bid Finvest Private Limited	-	-	6.05	3.36	-
Kabel Buildcon Solutions Private Limited	-	-	3.18	1.77	-
Dividends received from quoted equity investments					
Ram Ratna Wires Limited	-	-	7.05	1.41	0.71

(₹ in millions)

Particulars	For the period ended 30 June 2023	For the period ended 30 June 2022	For the year ended 31 March 2023	For the year ended 31 March 2022	For the year ended 31 March 2021
Borrowings Accepted					
Ram Ratna Research and Holding Private Limited	-	-	-	-	7.50
Rameshwarlal Kabra (HUF)	-	-	-	-	13.50
Tribhuvanprasad Kabra (HUF)	-	-	-	-	2.60
Jag-Bid Finvest Private Limited	-	-	-	-	2.00
Mahendra Kumar Kabra (HUF)	-	-	-	-	2.10
Borrowings Repaid					
Ram Ratna Research and Holding Private Limited	-	-	-	-	15.60
Kabra Shreegopal Rameshwarlal (HUF)	-	-	-	-	14.17
Rameshwarlal Kabra (HUF)	-	-	-	-	37.91
Mahendra Kumar Kabra (HUF)	-	-	-	-	9.33
Tribhuvanprasad Kabra (HUF)	-	-	-	-	9.20
Mahesh Kabra (HUF)	-	-	-	-	6.05
Jag-Bid Finvest Private Limited	-	-	-	-	2.00

(₹ in millions)

Particulars	For the period ended 30 June 2023	For the period ended 30 June 2022	For the year ended 31 March 2023	For the year ended 31 March 2022	For the year ended 31 March 2021
Outstanding balances					
Security deposits Receivable					
Kabra Shreegopal Rameshwarlal (HUF)	1.50	1.50	1.50	1.50	1.50
Kabel Buildcon Solutions Private Limited	-	0.37	-	0.37	0.37
Trade Payable					
Ram Ratna International	49.82	43.12	34.04	31.61	19.86
Others	2.42	3.41	-	0.54	0.08
Advances to suppliers					
EPAVO Electricals Private Limited	3.43	0.01	17.98	2.70	-
Pratik Wire & Cable Machine Private Limited	3.40	0.32	4.67	0.31	-
Ram Ratna Wire Limited	33.93	-	33.93	-	-
Trade Receivable					
Ram Ratna International	235.89	373.62	9.19	71.85	174.78
Ram Ratna Wires Limited	0.15	5.11	26.85	0.00	0.33
Others	3.07	6.10	2.55	2.67	1.66

D) Transaction with Joint venture

(₹ in millions)

Particulars	For the period ended 30 June 2023	For the period ended 30 June 2022	For the year ended 31 March 2023	For the year ended 31 March 2022	For the year ended 31 March 2021
Sale of Goods					
RR-Imperial Electricals Limited	34.04	26.99	80.99	103.35	62.50
Trade Receivable					
RR-Imperial Electricals Limited	41.30	27.33	39.84	55.57	106.71

33.1: Includes provision of ₹ 0.13 millions for period ended 30 June 2023, (period ended 30 June 22 ₹ 0.13 millions, 31 March 2023 ₹ 0.50 millions, 31 March 2022 ₹ 0.51 millions, 31 March 2021 ₹ 0.42 ,millions) for post employment benefits and ₹ 0.25 millions for period ended 30 June 2023 (period ended 30 June 2022 ₹ 0.23 millions, 31 March 2023 ₹ 1.0 millions, 31 March 2022 ₹ 0.90 millions, 31 March 2021 ₹ 0.48 millions) for leave encashment.

33.2: All outstanding balances are unsecured and are repayable/receivable in cash and all the transactions with these related parties are priced on arm's length basis.

33.3: Pre and post elimination numbers are the same and hence there are no elimination involved.

Note 34 : Transactions with struck off Company

The Company did not have any material transactions with companies struck off under Section 248 of the Companies Act, 2013 or Section 560 of Companies Act, 1956 during the period ended 30 June 2023 ,30 June 2022, financial years ended 31 March 2023, 31 March 2022 and 31 March 2021.

Note 35 : Employee Benefits**A) Defined Benefit Plan- Gratuity (Funded)**

The employees' Gratuity Fund Scheme, is a defined benefit plan. The scheme is maintained and administered by Life Insurance Corporation of India (LIC) to which the Company makes periodical contributions. Under the said scheme, every employee who has completed at least five years of service usually gets gratuity on departure @ 15 days of last drawn salary for each completed year of service. The present value of obligation is determined based on actuarial valuation using the Projected Unit Credit Method.

The following table summaries the components of net benefit expense recognised in the Restated Consolidated Statement of Profit and Loss and the funded status and amounts recognised in the Restated Consolidated Statement of Assets and Liabilities :

(₹ in millions)

Particulars	Gratuity				
	For the period ended 30 June 2023	For the period ended 30 June 2022	For the year ended 31 March 2023	For the year ended 31 March 2022	For the year ended 31 March 2021
i) Change in defined benefit obligation					
Obligation at the beginning of the period / year	231.72	167.44	167.44	138.55	119.62
Current service cost	7.29	6.91	28.08	21.65	19.51
Interest cost	2.94	2.94	11.75	8.13	7.26
Benefits paid	(3.84)	(1.13)	(10.15)	(8.12)	(4.41)
Remeasurement (gains)/ losses	1.39	1.55	5.55	7.23	(3.43)
Liability assumed / (settled)*	-	29.05	29.05	-	-
Defined benefit obligation at the end of the period / year	239.50	206.76	231.72	167.44	138.55
ii) Change in plan assets					
Fair value of plan assets at the beginning of the period / year	240.86	179.56	179.56	154.42	98.14
Return on plan assets	2.94	2.94	11.75	9.13	5.87
Employer contributions	-	-	29.64	24.13	54.22
Benefits paid	(3.84)	(1.13)	(10.15)	(8.12)	(4.42)
Remeasurement gains/ (losses)	0.26	0.13	1.01	-	0.61
Liability assumed / (settled)*	-	29.05	29.05	-	-
Fair value of plan assets at the end of the period / year	240.22	210.55	240.86	179.56	154.42
iii) Amount recognized in the Restated Consolidated Statement of Assets and Liabilities					
Present value of funded defined benefit obligation	239.50	206.76	231.72	167.44	138.55
Fair value of plan assets at the end of the year	240.22	210.55	240.86	179.56	154.42
Amount recognized in the Restated Consolidated Statement of Assets and Liabilities	(0.72)	(3.79)	(9.14)	(12.12)	(15.87)
iv) Expenses recognized in the Restated Consolidated Statement of Profit and Loss					
Employee benefits expense					
Current service cost	7.29	6.91	28.08	21.65	19.51
Interest cost	2.94	2.94	11.75	8.13	7.26
Expected return on plan assets	(2.94)	(2.94)	(11.75)	(9.13)	(5.87)
	7.29	6.91	28.08	20.65	20.90

(₹ in millions)

Particulars	Gratuity				
	For the period ended 30 June 2023	For the period ended 30 June 2022	For the year ended 31 March 2023	For the year ended 31 March 2022	For the year ended 31 March 2021
Other comprehensive income					
Remeasurement gains/ (losses)	(0.26)	(0.13)	(1.02)	-	(0.61)
Actuarial loss arising from changes in financial assumption	(1.88)	(2.71)	(7.51)	8.62	1.75
Actuarial (gain) arising from changes in demographic assumption	-	-	-	(1.98)	(0.68)
Actuarial (gain)/loss arising on account of experience changes	3.28	4.65	13.07	0.59	(4.50)
	1.14	1.81	4.54	7.23	(4.04)
v) Investment details					
LIC- Administrator of the plan fund	240.22	210.55	240.85	179.56	154.42
vi) Principal assumption used in determining defined benefit obligation					
Discount rate (per annum)	7.40%	6.95%	7.40%	6.95%	6.25%
Salary escalation rate (per annum)	8.50%	8.50%	8.50%	8.50%	7.00%
Attrition rate					
18-20 year	5.00%	5.00%	5.00%	5.00%	4.00%
21-30 year	12.00%	12.00%	12.00%	12.00%	12.00%
31-50 year	10.00%	10.00%	10.00%	10.00%	8.00%
51-57 year	15.00%	15.00%	15.00%	15.00%	9.00%
Retirement Age:	58.00	58.00	58.00	58.00	58.00
Mortality rate	Indian Assured Lives Mortality (2012-14) Ult table	Indian Assured Lives Mortality (2012-14) Ult table	Indian Assured Lives Mortality (2012-14) Ult table	Indian Assured Lives Mortality (2012-14) Ult table	Indian Assured Lives Mortality (2012-14) Ult table
vii) Sensitivity analysis					
Increase in 50 bps on defined benefit obligation					
Change in discount rate	223.85	121.13	223.85	161.51	132.85
Change in salary escalation	239.54	130.03	239.55	173.37	144.44
Decrease in 50 bps on defined benefit obligation					
Change in discount rate	240.07	130.30	240.08	173.74	144.66
Change in salary escalation	224.22	121.33	224.23	161.77	132.96
viii) Maturity profile of defined benefit obligation (undiscounted value)					
Within the next 12 months (next annual reporting period)	33.44	15.63	33.44	20.84	16.80
Between 2 and 5 years	74.01	52.39	74.01	69.85	45.53
Between 5 and 9 years	114.78	48.33	114.78	64.44	47.71
10 and above years	220.03	118.28	220.03	157.71	155.30

- The average duration of the defined benefit plan obligation at the end of the reporting period is 7.30 years, (period ended 30 June 2022 7.30 years, 31 March 2023 7.30 years, 31 March 2022 7.30 years, 31 March 2021 8.64 years)
- The estimates of rate of escalation in salaries considered in actuarial valuation, takes into account inflation, seniority, promotion and other relevant factors including supply and demand in the employment market. The above information is certified by the actuary.
- Discount rate is based on the prevailing market yields of Indian Government securities as at the balance sheet date for the estimated term of the obligations.
- The sensitivity analysis above have been determined based on a method that extrapolates the impact on defined benefit obligation as a result of reasonable changes in key assumptions occurring at the end of the reporting period. The sensitivity analysis may not be representative of the actual change in the defined benefit obligation as it is unlikely that the change in assumptions would occur in isolation of one another as some of the assumptions may be correlated. Furthermore, in presenting the above sensitivity analysis the present value of defined benefit obligation has been calculated using the projected unit credit method.

R R KABEL LIMITED
Annexure VI - Notes to Restated Consolidated Financial Information

(v) The Company's Gratuity Fund is managed by Life Insurance Corporation of India. The plan assets under the fund are deposited under State and Central Government Securities, Money market instruments such as NCD / Bonds etc and in equity as mentioned below:

Assets	% of Investment pattern as on 30 June 2023	% of Investment pattern as on 30 June 2022	% of Investment pattern as on 31 March 2023	% of Investment pattern as on 31 March 2022	% of Investment pattern as on 31 March 2021
Central Govt Securities	30.94	23.57	30.94	23.57	20.63
State Govt Securities	38.41	45.67	38.41	45.67	46.91
C.B.L.O., Bank balance etc.	12.32	3.29	12.32	3.29	4.02
Other approved securities	0.01	0.01	0.01	0.01	0.01
NCD / Bonds	6.35	17.57	6.35	17.57	18.75
Equity	11.97	9.89	11.97	9.89	9.68
Total	100.00	100.00	100.00	100.00	100.00

(vi) Expected contribution of plan in next year is ₹ 29.60 millions, (period ended 30 June 2022 ₹ 24.13 millions, 31 March 2023 ₹ 29.60 millions, 31 March 2022 ₹ 24.13 millions and 31 March 2021 ₹ 54.22 millions).

(vii) The Company has purchased insurance policy, which is basically a year-on-year cash accumulation plan in which the interest rate is declared on yearly basis and is guaranteed for a period of one year. The insurance Company as part of the policy rules, makes payment of all gratuity outgoes happening during the year (subject to sufficiency of funds under the policy). The policy, thus, mitigates the liquidity risk. However, being a cash accumulation plan, the duration of assets is shorter compared to the duration of liabilities. Thus, the Company is exposed to movement in interest rate (in particular, the significant fall in interest rates, which should result in an increase in liability without corresponding increase in the asset)

B) Defined Contribution Plan - Provident fund and Employees state insurance

The Company makes its contribution along with the share of employees' contribution deducted from salary on monthly basis to Employees' Provident Fund and Employees state insurance corporation administered by the Central and state Government respectively. The Company's Contribution is charged to Statement of Profit and Loss. The Company has no obligation for any further contribution in case of any shortfall. The details of contribution are as under :-

(₹ in millions)

Particulars	For the period ended 30 June 2023	For the period ended 30 June 2022	For the year ended 31 March 2023	For the year ended 31 March 2022	For the year ended 31 March 2021
Contribution to Provident Fund*	22.76	18.72	82.82	58.90	46.10
Contribution to Employees state insurance	1.42	0.91	4.99	3.47	3.98

*Includes contribution of ₹ 0.16 millions, (period ended 30 June 2022 ₹ 0.12 millions, 31 March 2023 ₹ 0.61 millions, 31 March 2022 ₹ 1.27 millions, and 31 March 2021 ₹ 0.70 millions) for Research and Development Employees.

C) Other Employee benefits - Compensated absences

The employees are entitled for the compensation in respect of unavailed leave as per the policy of the Company. The liability towards compensated absences is recognised based on actuarial valuation carried out using Projected Unit Credit method.

(₹ in millions)

Particulars	For the period ended 30 June 2023	For the period ended 30 June 2022	For the year ended 31 March 2023	For the year ended 31 March 2022	For the year ended 31 March 2021
Amount recognized in the Restated Consolidated Statement of Assets and Liabilities					
i) Current Liability	33.50	49.38	28.50	43.06	32.96
ii) Non- Current Liability	153.70	82.25	140.81	71.72	60.44

Actuarial Assumptions	For the period ended 30 June 2023	For the period ended 30 June 2022	For the year ended 31 March 2023	For the year ended 31 March 2022	For the year ended 31 March 2021
Discount Rate	7.40%	6.95%	7.40%	6.95%	6.25%
Salary growth rate	8.50%	8.50%	8.50%	8.50%	7.00%
Attrition rate					
18-20 year	5.00%	5.00%	5.00%	5.00%	4.00%
21-30 year	12.00%	12.00%	12.00%	12.00%	12.00%
31-40 year	10.00%	10.00%	10.00%	10.00%	8.00%
41-50 year	7.00%	10.00%	7.00%	7.00%	7.00%
51-57 year	15.00%	15.00%	15.00%	15.00%	9.00%

Note 36 : Calculations of Earnings Per Share	For the period ended 30 June 2023	For the period ended 30 June 2022	For the year ended 31 March 2023	For the year ended 31 March 2022	For the year ended 31 March 2021
Profit for the period/year (₹ in millions)	743.48	181.42	1,898.72	2,139.37	1,353.98
Movement of equity shares:					
Number of equity share at the beginning of the period/year	111,068,856	111,068,856	111,068,856	111,068,856	111,068,856
Number of equity share at the end of the period/year	111,068,856	111,068,856	111,068,856	111,068,856	111,068,856
Weighted average number of equity shares outstanding during the period/year	111,068,856	111,068,856	111,068,856	111,068,856	111,068,856
Add : Weighted average Equity Options (Time Based)	211,160	240,760	148,393	177,902	69,588
Add : Weighted average Equity Options (Performance Based)	51,860	48,150	29,634	35,580	27,841
Weighted average number of equity shares outstanding during the period/year (for diluted)	111,331,876	111,357,766	111,246,883	111,282,338	111,166,285
Face value of equity share (in ₹) (Note 43)	5.00	5.00	5.00	5.00	5.00
Earnings per share					
Basic Earnings Per Share (in ₹)	6.69	1.63	17.09	19.26	12.19
Diluted Earnings Per Share (in ₹)	6.68	1.63	17.07	19.22	12.18

Note 36.1 Share split and bonus issue

The basic and diluted earnings per share for the previous periods/years presented have been calculated/restated after considering the share split and issue of bonus shares during the year ended 31 March 2023. Further, appropriate effect of potential equity shares to be issued has been considered in above EPS calculation on account of share split and of issue of bonus shares in relation to compulsory convertible preference shares and options granted to employees under the ESOP scheme of the Company.

R R KABEL LIMITED
Annexure VI - Notes to Restated Consolidated Financial Information

Note 37 :

Accounting classification and fair values:

Carrying amounts and fair values of financial assets and financial liabilities, including their levels in the fair value hierarchy, are presented below.

A) Category-wise classification of financial instruments:

Assets	Refer Note	Non-Current			Current			For the year ended 31 March 2021	For the year ended 31 March 2021
		For the period ended 30 June 2023	For the period ended 30 June 2022	For the year ended 31 March 2023	For the period ended 30 June 2023	For the period ended 30 June 2022	For the year ended 31 March 2023		
Financial assets measured at fair value through other comprehensive income (FVTOCI)									
Investments in quoted equity shares (Note 37.1)	3A	782.49	229.74	446.16	278.97	113.02	-	-	-
Investments in unquoted equity shares (Note 37.1)	3A	136.97	127.85	134.89	126.60	121.56	-	-	-
Financial assets measured at fair value through profit and loss (FVTPL)									
Investments in mutual funds	3B	-	-	-	-	-	2,792.08	2,006.99	1,960.20
Derivative assets - mark to market	5B	-	-	-	-	-	29.51	30.25	4.63
Financial assets measured at amortised cost (Note 37.3)									
Security deposits	5A and 5B	35.85	21.43	32.42	20.59	15.10	7.48	14.92	9.93
Inter corporate deposits	4A and 4B	-	-	-	-	-	-	-	-
Loan to employees	4A and 4B	1.99	0.39	2.87	0.52	0.96	5.20	4.48	6.48
Term Deposits held as margin money or security against borrowing, guaranties or other commitments	5A	25.44	0.20	3.35	1.13	0.80	-	-	-
Term Deposits held as margin money or security against borrowing, guaranties or other commitments	5B	-	-	-	-	-	25.79	23.51	18.21
Interest accrued on term deposits held as margin money or security against borrowing, guaranties or other commitments	5B	-	-	-	-	-	1.56	1.68	1.11
Others (Insurance claim and recoverable expenses)	5B	-	-	-	-	-	111.97	17.98	0.86
Trade receivables	9	-	-	-	-	-	6,315.23	5,384.47	4,203.64
Cash and cash equivalents	10A	-	-	-	-	-	151.41	67.07	83.96
Bank Balances other than cash and cash equivalents	10B	-	-	-	-	-	-	500.40	0.70

(₹ in millions)

R R KABEL LIMITED
Annexure VI - Notes to Restated Consolidated Financial Information

(₹ in millions)

Liabilities	Refer Note	Non-Current			Current				
		For the period ended 30 June 2023	For the period ended 30 June 2022	For the year ended 31 March 2023	For the period ended 30 June 2023	For the period ended 30 June 2022	For the year ended 31 March 2023	For the year ended 31 March 2022	For the year ended 31 March 2021
Financial Liabilities measured at fair value through profit or loss (FVTPL)									
Derivative liabilities - mark to market	15B	-	-	-	8.17	35.35	22.24	0.07	3.99
Financial Liabilities measured at amortised cost (Note 37.3)									
Borrowings	13A and 13B	187.49	511.92	268.59	3,850.16	4,518.00	4,889.82	4,617.98	4,274.31
Obligation under Lease	14A and 14B	613.88	358.26	564.05	83.42	48.67	81.95	32.51	30.66
Security deposits and others	15B	-	-	-	59.37	48.57	55.87	24.87	23.27
Unclaimed dividend	15B	-	-	-	-	-	0.40	-	0.70
Retention money relating to capital expenditure	15A and 15B	21.89	19.23	21.29	21.45	32.18	29.36	44.05	16.67
Interest accrued	15B	-	-	-	23.75	7.33	19.82	6.35	2.23
Accrued salary and benefits	15B	-	-	-	187.09	161.27	145.45	102.37	69.21
Director's Commission	15B	-	-	-	9.88	2.56	26.40	27.23	19.23
Creditors for capital expenditure	15B	-	-	-	70.50	36.89	61.45	27.39	19.98
Other payables	15B	-	-	-	0.66	-	16.73	8.16	9.54
Trade payables	19	-	-	-	4,527.17	3,804.80	4,401.29	1,678.74	1,135.03

Note 37.1 Investment are not held for trading. Upon the application of Ind AS 109 - Financial Instruments, the Company has chosen to measure said investments in equity instrument at FVTOCI irrevocably as the management believes that presenting fair value gains and losses relating to the said investments in the statement of profit and loss may not be indicative of the performance of the Company.

Note 37.2 Investment in joint venture amounting to ₹ 163.73 millions for period ended 30 June 2023, (period ended 30 June 2022 ₹ 163.73 millions, 31 March 2023 ₹ 163.73 millions, 31 March 2022 ₹163.73 millions, 31 March 2021 ₹163.73 millions are measured at cost in accordance with Ind AS 27 requirements since the same is scoped out of Ind AS - 109 for the purpose of measurement, the same have not been disclosed in tables above.

Note 37.3 The Company has not disclosed the fair values of financial instruments carried at amortised cost because their carrying amounts are a reasonable approximation of fair value.

B) Fair Value Measurements

(i) All assets and liabilities for which fair value is measured or disclosed in the financial statements are categorized within the fair value hierarchy that categorizes into three levels, described as follows:

Level 1 — quoted (unadjusted) market prices in active markets for identical assets or liabilities.

Level 2 — inputs other than quoted prices included within Level 1 that are observable for the asset or liability, either directly or indirectly.

Level 3 — inputs that are unobservable for the asset or liability.

R R KABEL LIMITED
Annexure VI - Notes to Restated Consolidated Financial Information

(ii) The following tables provide the fair value measurement hierarchy of the Company's financial assets and liabilities:

(₹ in millions)

Financial Assets / Financial Liabilities as at 30 June 2023	Fair value	Fair value hierarchy		
		Level 1	Level 2	Level 3
Financial assets measured at fair value through other comprehensive income				
Investments in quoted equity shares (Note 3A)	782.49	782.49	-	-
Investments in unquoted equity shares (Note 3A)	136.97	-	-	136.97
Financial assets measured at fair value through profit or loss (FVTPL)				
Investments in mutual funds (Note 3B)	2,792.08	2,792.08	-	-
Derivative assets -mark to market (Note 5B)	29.51	-	29.51	-
Financial liabilities measured at fair value through profit or loss (FVTPL)				
Derivative liability -mark to market (Note 15B)	8.17	-	8.17	-

(₹ in millions)

Financial Assets / Financial Liabilities as at 30 June 2022	Fair value	Fair value hierarchy		
		Level 1	Level 2	Level 3
Financial assets measured at fair value through other comprehensive income				
Investments in quoted equity shares (Note 3A)	229.74	229.74	-	-
Investments in unquoted equity shares (Note 3A)	127.85	-	-	127.85
Financial assets measured at fair value through profit or loss (FVTPL)				
Investments in mutual funds (Note 3B)	2,006.99	2,006.99	-	-
Derivative assets -mark to market (Note 5B)	30.25	-	30.25	-
Financial liabilities measured at fair value through profit or loss (FVTPL)				
Derivative liabilities - mark to market (Note 15B)	35.35	-	35.35	-

(₹ in millions)

Financial Assets / Financial Liabilities as at 31 March 2023	Fair value	Fair value hierarchy		
		Level 1	Level 2	Level 3
Financial assets measured at fair value through other comprehensive income				
Investments in quoted equity shares (Note 3A)	446.16	446.16	-	-
Investments in unquoted equity shares (Note 3A)	134.89	-	-	134.89
Financial assets measured at fair value through profit or loss (FVTPL)				
Investments in mutual funds (Note 3B)	2,849.23	2,849.23	-	-
Derivative assets -mark to market (Note 5B)	14.03	-	14.03	-
Financial liabilities measured at fair value through profit or loss (FVTPL)				
Derivative liabilities -mark to market (Note 15B)	22.24	-	22.24	-

(₹ in millions)

Financial Assets / Financial Liabilities as at 31 March 2022	Fair value	Fair value hierarchy		
		Level 1	Level 2	Level 3
Financial assets measured at fair value through other comprehensive income				
Investments in quoted equity shares (Note 3A)	278.97	278.97	-	-
Investments in unquoted equity shares (Note 3A)	126.60	-	-	126.60
Financial assets measured at fair value through profit or loss (FVTPL)				
Investments in mutual funds (Note 3B)	2,054.74	2,054.74	-	-
Derivative assets -mark to market (Note 5B)	60.02	-	60.02	-
Financial liabilities measured at fair value through profit or loss (FVTPL)				
Derivative liabilities -mark to market (Note 15B)	0.07	-	0.07	-

(₹ in millions)

Financial Assets / Financial Liabilities as at 31 March 2021	Fair value	Fair value hierarchy		
		Level 1	Level 2	Level 3
Financial assets measured at fair value through other comprehensive income				
Investments in quoted equity shares (Note 3A)	113.02	113.02	-	-
Investments in unquoted equity shares (Note 3A)	121.56	-	-	121.56
Financial assets measured at fair value through profit or loss (FVTPL)				
Investments in mutual funds (Note 3B)	1,960.20	1,960.20	-	-
Derivative Assets -mark to market (Note 5B)	4.63	-	4.63	-
Financial liabilities measured at fair value through profit or loss (FVTPL)				
Derivative liability -mark to market (Note 15B)	3.99	-	3.99	-

Valuation techniques and significant unobservable inputs

The following tables show the valuation techniques used in measuring Level 2 and Level 3 fair values for financial instruments in the consolidated balance sheet, as well as the significant unobservable inputs used in measuring Level 3 fair values for financial instruments.

Financial instruments measured at fair value (Level 2 and Level 3)

Type	Valuation technique	Significant unobservable inputs	Inter-relationship between significant unobservable inputs and fair value measurement
Investments in unquoted equity shares (Note 3A)	Discounted cash flows: The valuation model considers the present value of the expected equity value, discounted using a risk-adjusted discount rate.	<ul style="list-style-type: none"> Expected Terminal growth rate 30 June 2023: 1 %, 30 June 2022: 1 %, 31 March 2023: 1 %, 31 March 2022: 1 %, 31 March 2021: 1 %. Risk-adjusted discount rate 30 June 2023: 7.05 %, 30 June 2022: 7.26 %, 31 March 2023: 7.26 %, 31 March 2022: 7.24 %, 31 March 2021: 10.88 %. 	<p>The estimated fair value would increase (decrease) if:</p> <ul style="list-style-type: none"> the expected terminal growth rate was higher (lower); or the risk-adjusted discount rate was lower (higher).
Forward contract receivable (Note 5B)	Forward pricing: The fair value is determined using quoted forward exchange rates at the reporting date and present value calculations based on high credit quality yield curves in the respective currencies.	Not applicable.	Not applicable.

The carrying amounts of financial assets and financial liabilities measured at amortised cost in the financial statements are reasonable approximation of their fair values since the Company does not anticipate that the carrying amount would be significantly different from the value that would eventually be received or settled.

Management uses its best judgment in estimating the fair value of its financial instruments. However, there are inherent limitations in any estimation technique. Therefore, for substantially all financial instruments, the fair value estimates presented above are not necessarily indicative of the amounts that the Company could have realised or paid in sale transactions as of respective dates. As such, fair value of financial instruments subsequent to the reporting dates may be different from the amounts reported at each reporting date.

There have been no transfers between Level 1 and Level 2 for the period ended 30 June 2023, 30 June 2022, years ended 31 March 2023, 31 March 2022 and 31 March 2021.

C) Financial Risk Management- Objectives and Policies

The Company is exposed to: (a) Market Risks comprising of Interest Rate Risk, Currency Rate Risk, Commodity Price Risk and Equity Price Risk (b) Liquidity Risk (c) Credit Risk comprising of trade receivable risk and financial instrument risk. The Company has well placed Risk Management Policy (RMP). The policy provide broad guidelines to identify the risk arising from these factors and provide guidelines to the team for its mitigation or at-least minimize its effect on income / expense of the Company . Team involved in RMP meets frequently to discuss the level of risk they foresee based on the conditions persisting.

The Company's exposure to Market Risk, Liquidity Risk and Credit Risk have been summarized below:

Market Risk :-**Interest Rate Risk:**

Interest rate risk is the risk that the fair value or future cash flow of a financial instrument will fluctuate because of changes in market interest rates. The Company is exposed to interest rate risk on short-term and long-term floating rate interest bearing liabilities. The Company's policy is to maintain a balance of fixed and floating interest rate borrowings and the proportion of fixed and floating rate debt is determined by prevailing interest rates. These exposures are reviewed by the management on a periodic basis.

The exposure of the Company's financial liabilities to interest rate risk based on liabilities as at reporting date is as follows:

(₹ in millions)

Particulars	Impact on profit before tax				
	For the period ended 30 June 2023	For the period ended 30 June 2022	For the year ended 31 March 2023	For the year ended 31 March 2022	For the year ended 31 March 2021
Increase in interest rate by 100 basis points	40.38	50.30	51.58	52.11	49.86
Decrease in interest rate by 100 basis points	(40.38)	(50.30)	(51.58)	(52.11)	(49.86)

(Calculated based on risk exposure outstanding as of date and assuming that all other variables, in particular foreign currency rates, remain constant).

R R KABEL LIMITED
Annexure VI - Notes to Restated Consolidated Financial Information
Foreign Currency Risk:

The Company is exposed to fluctuations in foreign currency exchange rates where transaction references more than one currency and/or where assets/liabilities are denominated in a currency other than the functional currency of the Company.

Exposures on foreign currency are managed through a hedging policy, which is reviewed periodically by the management. The Company usually enters into forward exchange contracts progressively based on their maturity to hedge the effects of movements in foreign currency exchange rates individually on assets and liabilities. The sources of foreign exchange risk for the Company are trade receivables, trade payables for imported materials and capital goods as well as foreign currency denominated borrowings. The policy of the Company is to determine on a regular basis what portion of the foreign exchange risk are to be hedged through forward exchange contracts.

The Company uses forward contracts to mitigate the risks associated with foreign currency fluctuations. The Company does not enter into any forward contracts which are intended for trading or speculative purposes.

a) The forward exchange contracts used for hedging foreign currency exposure and outstanding as at reporting date are as under:

As at 30 June 2023

(₹ in millions)

Particulars	USD	GBP	Euro	INR
Booked against import creditors	1.60	-	-	131.69
Booked against firm commitments or highly probable forecasted transactions -Against export trade receivable*	24.30	8.71	5.40	3,390.37

As at 30 June 2022

(₹ in millions)

Particulars	USD	GBP	Euro	INR
Booked against Foreign Currency Non-Resident borrowing -Against export trade receivable*	30.45	3.37	4.37	3,113.03

As at 31 March 2023

(₹ in millions)

Particulars	USD	GBP	Euro	INR
Booked against Foreign Currency Non-Resident borrowing	1.17	-	-	96.29
Booked against firm commitments or highly probable forecasted transactions -Against Import creditors -Against export trade receivable*	1.73 15.76	- 13.53	- 7.32	141.97 3,350.01

As at 31 March 2022

(₹ in millions)

Particulars	USD	GBP	Euro	INR
Booked against Foreign Currency Non-Resident borrowing	6.70	-	-	507.95
Booked against firm commitments or highly probable forecasted transactions -Against export trade receivable*	24.03	8.20	2.35	2,871.18

As at 31 March 2021

(₹ in millions)

Particulars	USD	GBP	Euro	INR
Booked against import creditors	0.35	-	-	25.65
Booked against firm commitments or highly probable forecasted transactions -Against export trade receivable*	12.58	9.10	0.62	1,918.71

* The Company follows a practice of booking forward contracts against firm commitments or highly probable forecast transactions. Certain of the export debtors as mentioned above will be settled against the forward contracts taken on firm commitments or highly probable transactions.

b) The details of foreign currency exposure that is not hedged by derivatives instrument or otherwise are as under:

As at 30 June 2023

(₹ in millions)

Particulars	USD	GBP	Euro	INR
Import creditors	1.51	-	0.60	177.63
Export trade receivables	5.81	0.01	0.29	503.06

As at 30 June 2022

(₹ in millions)

Particulars	USD	GBP	Euro	INR
Import creditors	10.34	-	0.33	843.46
Export trade receivables	6.20	0.28	0.09	523.51

R R KABEL LIMITED
Annexure VI - Notes to Restated Consolidated Financial Information

As at 31 March 2023 (₹ in millions)

Particulars	USD	GBP	Euro	INR
Import creditors	2.28	-	0.79	258.31
Export trade receivables	5.19	0.01	0.42	464.21

As at 31 March 2022 (₹ in millions)

Particulars	USD	GBP	Euro	INR
Import creditors	5.83	-	0.02	444.06
Export trade receivables	5.57	0.15	0.23	455.94

As at 31 March 2021 (₹ in millions)

Particulars	USD	GBP	Euro	INR
Import creditors	2.83	-	0.19	224.51
Export trade receivables	7.86	0.06	0.26	597.22

The exposure of the Company's foreign currency risk based on unhedged exposure as at the reporting date is as follows: (₹ in millions)

Particulars	Impact on profit before tax				
	For the period ended 30 June 2023	For the period ended 30 June 2022	For the year ended 31 March 2023	For the year ended 31 March 2022	For the year ended 31 March 2021
Increase in exchange rates by 5%	38.46	68.35	24.50	45.00	41.09
Decrease in exchange rates by 5%	(38.46)	(68.35)	(24.50)	(45.00)	(41.09)

Commodity Price Risk

The Company is exposed to the movement of copper and aluminium prices on the London Metal Exchange (LME). Any increase or decline in the prices of these commodities will have an impact on the profitability of the Company. As a general policy, the Company aims to purchase these commodities at prevailing market prices and also sell the products at price adjusted for prevailing market prices. The Company substantially ensures sale of products with simultaneous purchase of these commodities on back-to-back basis ensuring no or minimum price risk for the Company.

Equity Price Risk

Equity price risk relates to change in fair value of investments in the equity instruments measured at fair value through OCI. As at 30 June 2023 ₹ 919.46 millions (as at 30 June 2022 ₹ 353.41 millions, as at 31 March 2023 the carrying value of such equity instruments recognised at fair value through OCI amounts to ₹ 581.05 millions, 31 March 2022 ₹ 405.57 millions; 31 March 2021 ₹ 234.58 millions). The price risk arises due to uncertainties about the future market values of these investments and the same is classified in the balance sheet as fair value through OCI.

A sensitivity analysis demonstrating the impact of change in the carrying value of investment in equity instrument as at reporting date is given below:

(₹ in millions)

Particulars	Impact on OCI before tax				
	For the period ended 30 June 2023	For the period ended 30 June 2022	For the year ended 31 March 2023	For the year ended 31 March 2022	For the year ended 31 March 2021
Increase by 5%	45.97	17.88	29.05	20.28	11.73
Decrease by 5%	(45.97)	(17.88)	(29.05)	(20.28)	(11.73)

Liquidity Risk

Liquidity risk refers to the risk that the Company encounter difficulty in raising fund to meet its financial commitments. The objective of liquidity risk management is to maintain the liquidity and to ensure that funds are available for short operational needs and to fund Company's expansion projects. The Company has availed credit facility from the banks and financial institutions to meet its financial commitment in timely and cost effective manner.

The Company remains committed to maintaining a healthy liquidity and gearing ratio and strengthening the Restated Consolidated Statement of Assets and Liabilities. The maturity profile of the Company's financial liabilities based on the remaining period from the date of Restated Consolidated Statement of Assets and Liabilities to the contractual maturity date is given in the table below.

(₹ in millions)

At 30 June 2023	Less than 1 year	Between 1 to 5 years	Total	Carrying Value
Borrowings (Note 13A and 13B)	3,850.16	187.49	4,037.65	4,037.65
Derivative liabilities - mark to market (Note 15B)	8.17	-	8.17	8.17
Other financial liabilities (Note 15B)	372.70	-	372.70	372.70
Trade payables (Note 19)	4,527.17	-	4,527.17	4,527.17

R R KABEL LIMITED
Annexure VI - Notes to Restated Consolidated Financial Information

(₹ in millions)

At 30 June 2022	Less than 1 year	Between 1 to 5 years	Total	Carrying Value
Borrowings (Note 13A and 13B)	4,518.00	511.92	5,029.92	5,029.92
Derivative financial liabilities (Note 15B)	35.35	-	35.35	35.35
Other financial liabilities (Note 15B)	288.80	-	288.80	288.80
Trade payables (Note 19)	3,804.80	-	3,804.80	3,804.80

(₹ in millions)

At 31 March 2023	Less than 1 year	Between 1 to 5 years	Total	Carrying Value
Borrowings (Note 13A and 13B)	4,889.82	268.59	5,158.41	5,158.41
Derivative financial liabilities (Note 15B)	22.24	-	22.24	22.24
Other financial liabilities (Note 15B)	355.48	-	355.48	355.48
Trade payables (Note 19)	4,401.29	-	4,401.29	4,401.29

(₹ in millions)

At 31 March 2022	Less than 1 year	Between 1 to 5 years	Total	Carrying Value
Borrowings (Note 13A and 13B)	4,617.98	593.13	5,211.11	5,211.11
Derivative financial liabilities (Note 15B)	0.07	-	0.07	0.07
Other financial liabilities (Note 15B)	240.42	-	240.42	240.42
Trade payables (Note 19)	1,678.74	-	1,678.74	1,678.74

(₹ in millions)

At 31 March 2021	Less than 1 year	Between 1 to 5 years	Total	Carrying Value
Borrowings (Note 13A and 13B)	4,274.31	712.82	4,987.13	4,987.13
Derivative financial liabilities (Note 15B)	3.99	-	3.99	3.99
Other financial liabilities (Note 15B)	160.83	-	160.83	160.83
Trade payables (Note 19)	1,135.03	-	1,135.03	1,135.03

Credit Risk

Credit risk refers to the risk that counterparty will default on its contractual obligations resulting in financial loss to the Company. The company is exposed to credit risk for trade receivables and financial guarantees to dealers, derivative financial instruments and other financial assets.

The Company assess the counter party before entering into transactions and wherever necessary supplies are made against advance payment. The Company on continuous basis monitor the credit limit of the counter parties to mitigate or minimise the credit risk. The credit risk for the financial guarantees issued by the Company to banks for credit facilities availed by Company's dealers from bank is minimum as those parties have long vintage with the Company and they are also subject to credit risk assessment by bank on periodical basis. The credit risk on export receivables are limited as almost all export sales are made to parties having a long vintage with the Company and new parties are subject to necessary due diligence.

For trade receivables and financial guarantees, as a practical expedient, the Company computes credit loss allowance based on expected credit loss method. The movement in expected credit loss allowance is as under:

(₹ in millions)

Particulars	For the period ended 30 June 2023	For the period ended 30 June 2022	For the year ended 31 March 2023	For the year ended 31 March 2022	For the year ended 31 March 2021
Balance at the beginning of the period/ year	347.42	342.03	342.03	360.10	307.19
Add/(Less): Allowance for / (reversal) of expected credit loss	2.90	(8.91)	5.39	(18.07)	52.91
Balance at the end of the period/year	350.32	333.12	347.42	342.03	360.10

The expected credit loss allowance as presented above is for trade receivables with no significant financing component measured at an amount equal to lifetime expected credit loss.

R R KABEL LIMITED
Annexure VI - Notes to Restated Consolidated Financial Information

Note 38 : Segment Information

The Company has presented data relating to its segments based on its financial statements. Accordingly, in terms of paragraph 4 of the Indian Accounting Standard (Ind AS 108) "Operating Segments", disclosures related to segments are presented.

Accounting Policy

Identification of segments

An operating segment is a component of the company that engages in business activities from which it may earn revenues and incur expenses, whose operating results are regularly reviewed by the Company's Chief Operating Decision Maker ("CODM") to make decisions for which discrete financial information is available. The Board of directors monitors the operating results of all product segments separately for the purpose of making decisions about resource allocation and performance assessment based on an analysis of various performance indicators by business segments and geographic segments.

Segment revenue and expenses:

It has been identified to a segment on the basis of relationship to operating activities of the segment. The company generally accounts for intersegment sales and transfers at cost plus appropriate margins. Intersegment revenue and profit is eliminated at Company level.

Finance income earned and finance expense incurred are not allocated to individual segment and the same has been reflected at the Company level for segment reporting as the underlying instruments are managed on a company.

Segment assets and liabilities:

Segment assets and segment liabilities represent assets and liabilities of respective segments, however the assets and liabilities not identifiable or allocable on reasonable basis being related to enterprise as a whole have been grouped as unallocable. The accounting policies of the reportable segments are same as that of Company's accounting policies described. The company is organised into business units based on its products and services and has two reportable segments as follows.

Wire and Cable: Manufacture and sale of wires and cables.

Fast Moving Electrical Goods [FMEG] : Manufacture and sale of fans, LED lighting , switches, switchgears , water heaters, and domestic appliances.

A) The following summary describes the operations in each of the Company's reportable segments:

Following summary describes the operations in each of the Company's reportable segments: (₹ millions)

(₹ in Millions)

Particulars	For the period ended 30 June 2023				For the period ended 30 June 2022			
	Wires and Cables	Fast-Moving Electrical Goods	Elimination	Total	Wires and Cables	Fast-Moving Electrical Goods	Elimination	Total
Income								
Revenue from operations	14,230.82	1,742.32	-	15,973.14	11,058.27	1,300.83	-	12,359.10
Inter segment revenue	-	108.55	(108.55)	-	-	0.76	(0.76)	-
Total segment revenue from operations	14,230.82	1,850.87	(108.55)	15,973.14	11,058.27	1,301.59	(0.76)	12,359.10
Segment Profit/(loss) before tax and interest	1,246.44	(169.53)	-	1,076.91	461.88	(148.78)	-	313.10
Un-allocated items:								
Finance income				54.55				15.73
Finance costs				(144.24)				(80.77)
Share of gain / (loss) of joint venture (net of taxes)				6.66				(1.83)
Profit before tax				993.88				246.23
Tax Expense				250.40				64.81
Profit for the period/year				743.48				181.42
Depreciation and amortisation expenses	118.12	42.75	-	160.87	115.95	28.87	-	144.82

R R KABEL LIMITED
Annexure VI - Notes to Restated Consolidated Financial Information

(₹ in millions)

Particulars	For the year ended 31 March 2023				For the year ended 31 March 2022				For the year ended 31 March 2021			
	Wires and Cables	Fast-Moving Electrical Goods	Elimination	Total	Wires and Cables	Fast-Moving Electrical Goods	Elimination	Total	Wires and Cables	Fast-Moving Electrical Goods	Elimination	Total
Income												
Revenue from operations	49,585.32	6,406.68	-	55,992.00	41,112.71	2,746.65	-	43,859.36	25,202.47	2,036.94	-	27,239.41
Inter segment revenue	-	68.17	(68.17)	-	-	2.98	(2.98)	-	-	1.92	(1.92)	-
Total segment revenue from operations	49,585.32	6,474.85	(68.17)	55,992.00	41,112.71	2,749.63	(2.98)	43,859.36	25,202.47	2,038.86	(1.92)	27,239.41
Segment Profit/(loss) before tax and interest	3,515.83	(695.30)	-	2,820.53	3,227.22	(298.41)	-	2,928.81	2,268.87	(300.64)	-	1,968.23
Un-allocated items:												
Finance income				150.80				105.65				105.69
Finance costs				(420.86)				(232.84)				(270.56)
Share of gain of joint venture (net of taxes)				9.44				41.97				10.98
Profit before tax				2,559.91				2,843.59				1,814.34
Tax Expense				661.19				704.22				460.36
Profit for the period/year				1,898.72				2,139.37				1,353.98
Depreciation and amortisation expenses	456.94	139.33	-	596.27	419.92	40.92	-	460.84	414.72	32.78	-	447.50

Note 38.1 : Depreciation and amortisation expenses amount for the business segment "FMEG" was inadvertently presented as Rs. 28.44 millions instead of Rs. 32.79 millions for the year ended 31 March 2021 which has now been restated.(refer note B (7) in Annexure VII)

(B) Revenue by Geography

(₹ in millions)

Particulars	For the period ended 30 June 2023	For the period ended 30 June 2022	For the year ended 31 March 2023	For the year ended 31 March 2022	For the year ended 31 March 2021
Within India	11,669.41	8,922.80	43,290.10	33,783.82	21,371.75
Outside India	4,303.73	3,436.30	12,701.90	10,075.54	5,867.66
Revenue from operations	15,973.14	12,359.10	55,992.00	43,859.36	27,239.41

(C) Segment assets

(₹ in millions)

Particulars	For the period ended 30 June 2023			For the period ended 30 June 2022			
	Wires and Cables	Fast-Moving Electrical Goods	Total	Wires and Cables	Fast-Moving Electrical Goods	Elimination	Total
Segment assets	18,116.49	3,900.14	22,016.63	18,437.85	2,122.06	-	20,559.91
Unallocated assets:							
Non-current Investment	-	-	1,119.85	-	-	-	563.75
Current investments	-	-	2,792.08	-	-	-	2,006.99
Cash and bank balances	-	-	151.41	-	-	-	67.07
Bank balances other than cash and cash equivalents	-	-	-	-	-	-	-
Loans	-	-	7.19	-	-	-	4.87
Other financial assets	-	-	237.60	-	-	-	109.97
Income tax assets (net)	-	-	118.37	-	-	-	151.71
Total assets	18,116.49	3,900.14	26,443.13	18,437.85	2,122.06	-	23,464.27

Investment accounted for using equity method			200.39				206.16
--	--	--	--------	--	--	--	--------

R R KABEL LIMITED
Annexure VI - Notes to Restated Consolidated Financial Information

Particulars	For the year ended 31 March 2023			For the year ended 31 March 2022			For the year ended 31 March 2021		
	Wires and Cables	Fast-Moving Electrical Goods	Total	Wires and Cables	Fast-Moving Electrical Goods	Total	Wires & Cables	Fast-Moving Electrical Goods	Total
Segment assets	17,438.29	4,213.34	21,651.63	15,743.21	1,686.45	17,429.66	13,188.88	1,400.96	14,589.84
Unallocated assets:									
Non-current Investment	-	-	777.34	-	-	621.93	-	-	406.01
Current investments	-	-	2,849.23	-	-	2,054.74	-	-	1,960.20
Cash and bank balances	-	-	310.35	-	-	122.99	-	-	83.96
Bank balances other than cash and cash equivalents	-	-	500.40	-	-	-	-	-	0.70
Loans	-	-	3.47	-	-	2.72	-	-	7.44
Other financial assets	-	-	125.45	-	-	140.68	-	-	50.64
Income tax assets (net)	-	-	118.34	-	-	133.72	-	-	52.35
Total assets	17,438.29	4,213.34	26,336.21	15,743.21	1,686.45	20,506.44	13,188.88	1,400.96	17,151.14
Investment accounted for using equity method			196.29	-	-	216.36	-	-	171.43

(D) Segment liabilities

(₹ in millions)

Particulars	For the period ended 30 June 2023			For the period ended 30 June 2022		
	Wires and Cables	Fast-Moving Electrical Goods	Total	Wires and Cables	Fast-Moving Electrical Goods	Total
Segment liabilities	4,420.58	1,627.94	6,048.52	3,847.43	1,264.91	5,112.34
Unallocated liabilities:						
Borrowings (Non-Current and Current, including Current Maturity)	-	-	4,037.65	-	-	5,016.99
Lease liabilities	-	-	697.30	-	-	406.92
Deferred tax liabilities (net)	-	-	191.04	-	-	125.84
Income tax liabilities (net)	-	-	229.54	-	-	-
Total	4,420.58	1,627.94	11,204.05	3,847.43	1,264.91	10,662.09

Particulars	For the year ended 31 March 2023			For the year ended 31 March 2022			For the year ended 31 March 2021		
	Wires and Cables	Fast-Moving Electrical Goods	Total	Wires and Cables	Fast-Moving Electrical Goods	Total	Wires and Cables	Fast-Moving Electrical Goods	Total
Segment liabilities	4,355.14	1,766.70	6,121.84	1,877.01	678.52	2,555.53	1,069.44	474.87	1,544.31
Unallocated liabilities:									
Borrowings (Non-Current and Current, including Current Maturity)	-	-	5,158.41	-	-	5,202.06	-	-	4,978.34
Lease liabilities	-	-	646.00	-	-	114.77	-	-	83.30
Deferred tax liabilities (net)	-	-	148.67	-	-	131.05	-	-	78.88
Income tax liabilities (net)	-	-	64.34	-	-	-	-	-	-
Total	4,355.14	1,766.70	12,139.26	1,877.01	678.52	8,003.41	1,069.44	474.87	6,684.83

E) All non current assets of the Company are located in India.

F) There is no transaction with single external customer which amounts to 10% or more of the Company's revenue.

R R KABEL LIMITED
Annexure VI - Notes to Restated Consolidated Financial Information

Note 39 : Details of Loans, Guarantee and Investments U/s 186 of the Companies Act, 2013

(₹ in Millions)

Party Name	Nature of Transaction	As at 30 June 2023	As at 30 June 2022	As at 31 March 2023	As at 31 March 2022	As at 31 March 2021
Ram Ratna Wires Limited	Investment	782.37	229.67	446.09	278.91	113.00
Comfort Intech Limited	Investment	0.12	0.07	0.07	0.06	0.02
MEW electricals Ltd	Investment	136.97	127.85	134.89	126.60	121.56
RR-Imperial Electricals Limited - Bangladesh	Investment	200.39	206.16	196.29	216.36	171.43

There are no new investments made during the period / year. Above represents carrying amount of existing investments as at respective balance sheet date.

Note 40: Right of use assets :-

i) The Company as a lessee

The Company's lease asset classes primarily consist of leases for buildings. The Company assesses whether a contract contains a lease, at inception of a contract. A contract is, or contains, a lease if the contract conveys the right to control the use of an identified asset for a period of time in exchange for consideration. To assess whether a contract conveys the right to control the use of an identified asset, the co assesses whether: (i) the contract involves the use of an identified asset (ii) the Company has substantially all of the economic benefits from use of the asset through the period of the lease and (iii) the co has the right to direct the use of the asset.

At the date of commencement of the lease, the Company recognizes a right-of-use asset ("ROU") and a corresponding lease liability for all lease arrangements in which it is a lessee, except for leases with a term of twelve months or less (short-term leases), variable lease and low value leases. For these short-term, variable lease and low value leases, the co recognizes the lease payments as an operating expense on a straightline basis over the term of the lease.

Certain lease arrangements include the options to extend or terminate the lease before the end of the lease term. ROU assets and lease liabilities includes these options when it is reasonably certain that they will be exercised.

Right-of-use assets are depreciated from the commencement date on a straight-line basis over the shorter of the lease term and useful life of the underlying asset. Right of use assets are evaluated for recoverability whenever events or changes in circumstances indicate that their carrying the value-in-use) is determined on an individual asset basis unless the asset does not generate cash flows that are largely independent of those from other assets. In such cases, the recoverable amount is determined for the Cash Generating Unit (CGU) to which the asset belongs.

The lease liability is initially measured at amortized cost at the present value of the future lease payments. The lease payments are discounted using the interest rate implicit in the lease or, if not readily determinable, using the incremental borrowing rates in the country of domicile of these leases. Lease liabilities are remeasured with a corresponding adjustment to the related right of use asset if the co changes its assessment if whether it will exercise an extension or a termination option.

Lease liability and ROU asset have been separately presented in the Restated Consolidated Statement of Assets and Liabilities and lease payments have been classified as financing cash flows.

ii) The Company as a lessor

Leases for which the Company is a lessor is classified as a finance or operating lease. Whenever the terms of the lease transfer substantially all the risks and rewards of ownership to the lessee, the contract is classified as a finance lease. All other leases are classified as operating leases. For operating leases, rental income is recognized on a straight line basis over the term of the relevant lease.

On application of Ind AS 116, the nature of expenses has changed from lease rent in previous periods to depreciation cost for the right-to-use asset, and finance cost for interest accrued on lease liability.

iii) Others

- Applied a single discount rate to a portfolio of leases of similar assets in similar economic environment with a similar end date
- Applied the exemption not to recognize right-of-use assets and liabilities for leases with less than 12 months of lease term on the date of initial application, variable lease and low value asset.
- Excluded the initial direct costs from the measurement of the right-of-use asset at the date of initial application.
- Applied the practical expedient in the assessment of which transactions are leases. Accordingly, Ind AS 116 is applied only to contracts that were previously identified as leases under Ind AS 17.
- The effective interest rate for lease liabilities is 7.25 to 9.22% p.a., with maturity between 2021-2042.

The changes in the carrying value of right of use for the period ended 30 June 2023, 30 June 2022 and year ended 31 March 2023, 31 March 2022 and 31 March 2021 are shown in Note no 2(C).

R R KABEL LIMITED
Annexure VI - Notes to Restated Consolidated Financial Information

The following is the break-up of current and non-current lease liabilities :

Particulars	For the period ended 30 June 2023	For the period ended 30 June 2022	For the year ended 31 March 2023	For the year ended 31 March 2022	For the year ended 31 March 2021
Non-current lease liabilities	613.88	358.26	564.05	82.27	52.64
Current lease liabilities	83.42	48.67	81.95	32.51	30.66
Total	697.30	406.93	646.00	114.78	83.30

The following is the movement in lease liabilities :

Particulars	For the period ended 30 June 2023	For the period ended 30 June 2022	For the year ended 31 March 2023	For the year ended 31 March 2022	For the year ended 31 March 2021
As at the beginning of the period / year	646.00	114.78	114.78	83.30	42.98
Additions	73.20	311.35	623.99	73.78	70.25
Finance cost accrued during the period / year	13.32	2.38	41.02	3.11	3.11
Deletions	-	(5.47)	(37.54)	(5.49)	-
Payment of lease liabilities	(35.22)	(16.11)	(96.25)	(39.92)	(33.04)
As at the end of the period / year	697.30	406.93	646.00	114.78	83.30

The table below provides details regarding the contractual maturities of lease liabilities of non-cancellable contractual commitments as on an undiscounted basis.

Particulars	For the period ended 30 June 2023	For the period ended 30 June 2022	For the year ended 31 March 2023	For the year ended 31 March 2022	For the year ended 31 March 2021
Below 1 year	95.27	59.95	81.95	32.51	30.66
1 to 3 years	181.56	130.78	156.11	53.47	35.91
3 to 5 years	135.91	108.59	118.59	28.80	16.72
Above 5 years	284.56	107.61	289.35	-	-

The Company does not face a significant liquidity risk with regard to its lease liabilities as the current assets are sufficient to meet the obligations related to lease liabilities as and when they fall due.

The following are the amounts recognised in Restated Consolidated statement of profit and loss:

(₹ in Millions)

Particulars	For the period ended 30 June 2023	For the period ended 30 June 2022	For the year ended 31 March 2023	For the year ended 31 March 2022	For the year ended 31 March 2021
Amortisation expense of right-of-use assets	29.43	29.44	93.48	38.60	30.47
Interest expense on lease liabilities	13.32	2.38	41.02	3.10	3.11
Expense relating to short-term leases (included in other expenses)	5.64	4.76	13.32	15.52	9.52
	48.39	36.58	147.82	57.22	43.10

Lease contracts entered by the Company majorly pertains for Marketing offices and warehouse taken on lease to conduct its business in the ordinary course. The Company does not have any lease restrictions and commitment towards variable rent as per the contract.

Note 41 : Research and Development

The Company is continuously engaged in Research & Development of new product and process improvement of existing products, in which the Company operates. Detail of expenses incurred on Research & Development activities during the period/year, are as under:

(₹ in Millions)

Particulars	For the period ended 30 June 2023		For the period ended 30 June 2022	
Capital expenditure *		0.53		-
Revenue expenditure				
- Cost of raw material	3.12		4.37	
- Salary and wages	4.14		3.15	
- Other expenses	0.34		0.26	
- Sale of scrap	(1.61)	5.99	(3.06)	4.72
Total		6.52		4.72

R R KABEL LIMITED
Annexure VI - Notes to Restated Consolidated Financial Information

(₹ in Millions)

Particulars	For the year ended 31 March 2023		For the year ended 31 March 2022		For the year ended 31 March 2021	
Capital expenditure *		0.34		2.84		4.19
Revenue expenditure						
- Cost of raw material	18.76		15.51		21.45	
- Salary and wages	14.95		35.58		15.69	
- Other expenses	0.89		1.01		0.97	
- Sale of scrap	(13.02)	21.58	(10.24)	41.86	(17.17)	20.94
Total		21.92		44.70		25.13

* Capital expenditure included in plant and machinery reported in Note : 2A

Note 42: Capital Management

For the purpose of the Company's capital management, capital includes issued capital (Equity and Preference) and all other equity reserves attributable to the equity shareholders of the Company.

The primary objective of the Company's Capital Management is to maximize the Shareholder value and to safeguard the company's ability to meet its Liquidity requirements (including its commitments in respect of capital expenditure) and repay loans as they fall due.

The Company manages its capital structure and makes adjustments in the light of changes in economic conditions and requirements of the financial covenants and to continue as a going concern. The Company monitors using a gearing ratio which is net debts divided by total capital plus net debt. The company includes within net debt, interest bearing loans and borrowings, less cash and short term deposit. The company's policy is to keep the ratio below 1.5.

No changes were made in the objectives, policies or processes for managing capital during the period ended 30 June 2023, 30 June 2022 and year ended as at 31 March 2023, as at 31 March 2022 and as at 31 March 2021.

(₹ in Millions)

Particulars	As at	As at	As at	As at	As at
	30 June 2023	30 June 2022	31 March 2023	31 March 2022	31 March 2021
Net debt (Current & Non-Current borrowing less cash and cash equivalents) (A)	3,886.24	4,962.85	4,848.06	5,088.11	4,903.17
Total capital (equity) (B)	15,239.08	12,802.18	14,196.95	12,503.03	10,466.31
Total capital (equity) and net debt C=(A+B)	19,125.32	17,765.03	19,045.01	17,591.14	15,369.48
Gearing ratio (A/C)	0.20	0.28	0.25	0.29	0.32

Note 43: Events occurring after the Balance sheet Date

The Company evaluates events and transactions that occur subsequent to the balance sheet date but prior to approval of the financial statements to determine the necessity for recognition and/or reporting of any of these events and transactions in the financial statements.

Pursuant to board meeting held on 26 August 2023, the company has converted 3,843,140 compulsory convertible preference shares into equity shares in ratio of 1:4.

Note 44: Disclosure under Ind AS 115 "Revenue from Contracts with Customers"
(A) Reconciliation of amount of revenue recognized in the Restated Consolidated Statement of Profit and Loss with the contracted price:

(₹ in Millions)

Particulars	For the period ended	For the period ended	For the year ended	For the year ended	For the year ended
	30 June 2023	30 June 2022	31 March 2023	31 March 2022	31 March 2021
Revenue as per contracted price	16,559.27	12,587.24	57,785.41	44,193.53	27,378.67
Adjustment					
Less : Sales return	52.32	23.91	260.96	92.72	180.23
Less : Rebate and discounts	701.90	368.39	2,155.56	907.79	465.13
Other operating revenue	168.09	164.16	623.11	666.34	506.10
Revenue from contract with customers	15,973.14	12,359.10	55,992.00	43,859.36	27,239.41

The management determines that the segment information reported under Note 38 Segment reporting is sufficient to meet the disclosure objective with respect to disaggregation of revenue under Ind AS 115 Revenue from contract with Customers. Hence, no separate disclosures of disaggregated revenues are reported.

RR KABEL LIMITED
Annexure VI - Notes to Restated Consolidated Financial Information

(B) Contract Balances (Net of allowances expected credit loss)

The following table provides information about receivables, contract assets and contract liabilities from contracts with customers.

(₹ in Millions)

Particulars	For the period ended 30 June 2023	For the period ended 30 June 2022	For the year ended 31 March 2023	For the year ended 31 March 2022	For the year ended 31 March 2021
Receivables, which are included in 'trade and other receivables'	6,315.23	5,384.47	5,918.69	5,171.46	4,203.64
Contact Liabilities, Advances from customers	598.38	548.48	705.01	255.21	43.73
	5,716.85	4,835.99	5,213.68	4,916.25	4,159.91

The amount included in contract liabilities above as at 30 June 2022, 31 March 2022, 31 March 2022 and 31 March 2021 have been recognized as revenue during the respective subsequent periods/years.

(C) Significant Payment Terms

Generally, the Company provides credit period in the range of 30 to 75 days for customers.

Note 45 : Disclosure under rule 16A of Companies (Acceptance of Deposits) Rule 2014:

(₹ in Millions)

Particulars	For the period ended 30 June 2023	For the period ended 30 June 2022	For the year ended 31 March 2023	For the year ended 31 March 2022	For the year ended 31 March 2021
Money received from Director during the year	-	-	-	-	23.61
Balance outstanding at the end of the year	-	-	-	-	-

Note 46: The Company's international transactions with associated enterprises are at arm's length, as per the independent accountant's report for the year ended 31 March 2022 and 31 March 2021. The Management believes that the Company's international transactions with associated enterprises post 31 March 2022 continue to be at arm's length and that transfer pricing legislations will not have any impact on the financial statements, particularly on the amount of tax expenses for the year and the amount of provision for taxation at the year end.

Note 47: Restated Consolidated Financial Information is approved by Board of Director's in their meeting held on 30 August 2023.

Note 48: Employee Stock Option Plan

"RRKL ESOP 2020 (as amended in 2023)

On November 10, 2020, pursuant to the approval by the shareholders in the EGM and subsequently modified on April 11, 2023, the Board was authorized to create and grant from time to time, in one or more tranches, not exceeding 3,40,840 employee stock options to or for the benefit of such person(s) who are in employment of the Company, present and future, within the meaning of RRKL ESOP 2020 as amended in 2023 plan and eligible to receive such options under the Act, as may be decided under the RRKL ESOP 2020 plan as amended in 2023, exercisable into not more than 3,40,840 equity shares of face value of Rs.5/- each fully paid-up, where one employee stock option would convert into one fully paid-up equity share of face value of Rs. 5/- each upon exercise, on such terms and in such manner as the Board / Committee may decide in accordance with the provisions of the applicable laws and the provisions of RRKL ESOP 2020 plan.

50% of the Options granted to a Participating Employee will be subject to time-based conditions ("Time Based Options") and the balance 50% of the Options granted to a Participating Employee will be subject to performance-based conditions ("Performance Based Options"). There shall be a minimum period of one year between the grant of Options and the vesting of such Options. Plan shall vest based on the achievement of defined annual performance parameters as determined by the administrator (the nomination and remuneration committee). The performance parameters will be based on budgeted target EBITDA. These instruments will generally vest between a minimum of one to a maximum of five years from the grant date.

(A) The Company has granted employee stock options during the year ended 31 March 2021, 31 March 2022 and 31 March 2023 to its eligible employee under RRKL ESOP 2020 plan. Details of the same are as under:

Equity-settled share-based payment transaction

Particulars	Tranch I	Tranch II	Tranch III	Tranch IV	Tranch V
Time based options					
% of total options which are eligible to vest	20%	20%	20%	20%	20%
No. of Options	25,916	25,916	25,916	25,916	25,916
Grant Date	24 December 2020	24 December 2020	24 December 2020	24 December 2020	24 December 2020
Vesting date	24 December 2021	24 December 2021	13 May 2022	13 May 2023	13 May 2024
Exercise price (Rs. per share)	270.08	270.08	270.08	270.08	270.08
Fair Value per Stock Option (Rs. per share)	44.23	44.23	44.23	49.15	53.78
Performance based options					
% of total options which are eligible to vest	20%	20%	20%	20%	20%
No. of Options	25,916	25,916	25,916	25,916	25,916
Vesting date	24 December 2021	24 December 2021	30 June 2022	30 June 2023	30 June 2024
Exercise price (Rs. per share)	270.08	270.08	270.08	270.08	270.08
Fair Value per Stock Option (Rs. per share)	43.60	43.60	44.23	49.15	53.78
EBITDA Target (in ₹ millions)	Annual EBITDA target approved by the Board of directors from time to time basis and notified to the Participating Employee .				

R R KABEL LIMITED
Annexure VI - Notes to Restated Consolidated Financial Information

Particulars	Tranch I	Tranch II	Tranch III	Tranch IV	Tranch V
Time based options					
% of total options which are eligible to vest	20%	20%	20%	20%	20%
No. of Options	18,516	18,516	18,516	18,516	18,516
Grant Date	01 April 2021	01 April 2021	01 April 2021	01 April 2021	01 April 2021
Vesting date	01 April 2022	01 April 2023	01 April 2024	01 April 2025	01 April 2026
Exercise price (Rs. per share)	270.08	270.08	270.08	270.08	270.08
Fair Value per Stock Option (Rs. per share)	31.25	35.03	42.30	45.80	49.15
Performance based options					
% of total options which are eligible to vest	20%	20%	20%	20%	20%
No. of Options	18,516	18,516	18,516	18,516	18,516
Vesting date	30 June 2022	30 June 2023	30 June 2024	30 June 2025	30 June 2026
Exercise price (Rs. per share)	270.08	270.08	270.08	270.08	270.08
Fair Value per Stock Option (Rs. per share)	35.03	38.73	42.30	45.80	49.15
EBITDA Target (in ₹ millions)	Annual EBITDA target approved by the Board of directors from time to time basis and notified to the Participating Employee				

Particulars	Tranch I	Tranch II	Tranch III	Tranch IV	Tranch V
Time based options					
% of total options which are eligible to vest	20%	20%	20%	20%	20%
No. of Options	13,332	13,332	13,332	13,332	13,332
Grant Date	01 June 2021	01 June 2021	01 June 2021	01 June 2021	01 June 2021
Vesting date	01 June 2022	01 June 2023	01 June 2024	01 June 2025	01 June 2026
Exercise price (Rs. per share)	270.08	270.08	270.08	270.08	270.08
Fair Value per Stock Option (Rs. per share)	45.00	49.53	53.90	58.13	62.18
Performance based options					
% of total options which are eligible to vest	20%	20%	20%	20%	20%
No. of Options	13,332	13,332	13,332	13,332	13,332
Vesting date	30 June 2022	30 June 2023	30 June 2024	30 June 2025	30 June 2026
Exercise price (Rs. per share)	270.08	270.08	270.08	270.08	270.08
Fair Value per Stock Option (Rs. per share)	45.00	49.53	53.90	58.13	62.18
EBITDA Target (in ₹ millions)	Annual EBITDA target approved by the Board of directors from time to time basis and notified to the Participating Employee				

Particulars	Tranch I	Tranch II	Tranch III	Tranch IV	Tranch V
Time based options					
% of total options which are eligible to vest	20%	20%	20%	20%	20%
No. of Options	11,856	11,856	11,856	11,856	11,856
Grant Date	30 September 2021	30 September 2021	30 September 2021	30 September 2021	30 September 2021
Vesting date	30 September 2022	30 September 2023	30 September 2024	30 September 2025	30 September 2026
Exercise price (Rs. per share)	337.50	337.50	337.50	337.50	337.50
Fair Value per Stock Option (Rs. per share)	57.93	63.73	69.33	74.75	79.98
Performance based options					
% of total options which are eligible to vest	20%	20%	20%	20%	20%
No. of Options	11,856	11,856	11,856	11,856	11,856
Vesting date	30 September 2022	30 June 2023	30 June 2024	30 June 2025	30 June 2026
Exercise price (Rs. per share)	337.50	337.50	337.50	337.50	337.50
Fair Value per Stock Option (Rs. per share)	57.93	63.73	69.33	74.75	79.98
EBITDA Target (in ₹ millions)	Annual EBITDA target approved by the Board of directors from time to time basis and notified to the Participating Employee				

R R KABEL LIMITED
Annexure VI - Notes to Restated Consolidated Financial Information

Particulars	Tranch I	Tranch II	Tranch III	Tranch IV	Tranch V
Time based options					
% of total options which are eligible to vest	20%	20%	20%	20%	20%
No. of Options	2,964	2,964	2,964	2,964	2,964
Grant Date	31 March 2022	31 March 2022	31 March 2022	31 March 2022	31 March 2022
Vesting date	31 March 2023	08 November 2023	08 November 2024	08 November 2025	08 November 2026
Exercise price (Rs. per share)	337.50	337.50	337.50	337.50	337.50
Fair Value per Stock Option (Rs. per share)	161.75	161.75	170.50	178.83	186.70
Performance based options					
% of total options which are eligible to vest	20%	20%	20%	20%	20%
No. of Options	2,964	2,964	2,964	2,964	2,964
Vesting date	30 June 2023	30 June 2024	30 June 2025	30 June 2026	30 June 2027
Exercise price (Rs. per share)	337.50	337.50	337.50	337.50	337.50
Fair Value per Stock Option (Rs. per share)	161.75	170.50	178.83	186.70	194.20
EBITDA Target (in ₹ millions)	Annual EBITDA target approved by the Board of directors from time to time basis and notified to the Participating Employee				

Particulars	Tranch I	Tranch II	Tranch III	Tranch IV	Tranch V
Time based options					
% of total options which are eligible to vest	20%	20%	20%	20%	20%
No. of Options	1,484	1,484	1,484	1,484	1,484
Grant Date	31 March 2022	31 March 2022	31 March 2022	31 March 2022	31 March 2022
Vesting date	31 March 2023	01 November 2023	01 November 2024	01 November 2025	01 November 2026
Exercise price (Rs. per share)	337.50	337.50	337.50	337.50	337.50
Fair Value per Stock Option (Rs. per share)	161.75	161.75	170.50	178.83	186.70
Performance based options					
% of total options which are eligible to vest	20%	20%	20%	20%	20%
No. of Options	1,484	1,484	1,484	1,484	1,484
Vesting date	30 June 2023	30 June 2024	30 June 2025	30 June 2026	30 June 2027
Exercise price (Rs. per share)	337.50	337.50	337.50	337.50	337.50
Fair Value per Stock Option (Rs. per share)	161.75	170.50	178.83	186.70	194.20
EBITDA Target (in ₹ millions)	Annual EBITDA target approved by the Board of directors from time to time basis and notified to the Participating Employee				

Particulars	Tranch I	Tranch II	Tranch III	Tranch IV	Tranch V
Time based options					
% of total options which are eligible to vest	20%	20%	20%	20%	20%
No. of Options	4,448	4,448	4,448	4,448	4,448
Grant Date	31 March 2023	31 March 2023	31 March 2023	31 March 2023	31 March 2023
Vesting date	31 March 2024	28 February 2025	28 February 2026	28 February 2027	28 February 2028
Exercise price (Rs. per share)	450.00	450.00	450.00	450.00	450.00
Fair Value per Stock Option (Rs. per share)	240.84	248.30	255.91	262.98	269.56
Performance based options					
% of total options which are eligible to vest	20%	20%	20%	20%	20%
No. of Options	4,448	4,448	4,448	4,448	4,448
Vesting date	30 June 2024	30 June 2025	30 June 2026	30 June 2027	30 June 2028
Exercise price (Rs. per share)	450.00	450.00	450.00	450.00	450.00
Fair Value per Stock Option (Rs. per share)	242.98	250.98	258.40	265.29	271.73
EBITDA Target (in ₹ millions)	Annual EBITDA target approved by the Board of directors from time to time basis and notified to the Participating Employee				

RR KABEL LIMITED
Annexure VI - Notes to Restated Consolidated Financial Information

On March 20, 2023, pursuant to the approval by the shareholders in the EGM, the Board was authorized to create and grant from time to time, in one or more tranches, not exceeding 10,60,000 employee stock options to or for the benefit of such person(s) who are in employment of the Company, present and future, within the meaning of RR Kabel Limited Employee Stock Option Plan 2023 and eligible to receive such options under the Act, as may be decided under the RR Kabel Limited Employee Stock Option Plan 2023, exercisable into not more than 10,60,000 equity shares of face value of Rs. 5/- each fully paid-up, where one employee stock option would convert into one fully paid-up equity share of face value of Rs. 5/- each upon exercise, on such terms and in such manner as the Board / Committee may decide in accordance with the provisions of the applicable laws and the provisions of RR Kabel Limited Employee Stock Option Plan 2023.

50% of the Options granted to a Participating Employee will be subject to time-based conditions ("Time Based Options") and the balance 50% of the Options granted to a Participating Employee will be subject to performance-based conditions ("Performance Based Options"). There shall be a minimum period of one year between the grant of Options and the vesting of such Options. Plan shall vest based on the achievement of defined annual performance parameters as determined by the administrator (the nomination and remuneration committee). The performance parameters will be based on budgeted target EBITDA. These instruments will generally vest between a minimum of one to a maximum of five years from the grant date.

Particulars	Tranch I	Tranch II	Tranch III	Tranch IV	Tranch V
Time based options					
% of total options which are eligible to vest	20%	20%	20%	20%	20%
No. of Options	11,112	11,112	11,112	11,112	11,112
Grant Date	31 March 2023	31 March 2023	31 March 2023	31 March 2023	31 March 2023
Vesting date	31 March 2024	16 December 2024	16 December 2025	16 December 2026	16 December 2027
Exercise price (Rs. per share)	450.00	450.00	450.00	450.00	450.00
Fair Value per Stock Option (Rs. per share)	240.84	246.65	254.38	261.55	268.22
Performance based options					
% of total options which are eligible to vest	20%	20%	20%	20%	20%
No. of Options	11,112	11,112	11,112	11,112	11,112
Vesting date	30 June 2024	30 June 2025	30 June 2026	30 June 2027	30 June 2028
Exercise price (Rs. per share)	450.00	450.00	450.00	450.00	450.00
Fair Value per Stock Option (Rs. per share)	242.98	250.98	258.40	265.29	271.73
EBITDA Target (in ₹ millions)	Annual EBITDA target to be approved by the Board and notified to the Participating Employee as soon as reasonably practical after the annual budget is finalized				

(B) Fair Valuation

Weighted average fair value of options granted are as under :

Grant date	Option Value per unit granted	
	Term based	Performance based
24 December 2020	44.23	43.60
01 April 2021	40.70	42.20
01 June 2021	53.75	53.75
30 September 2021	69.13	69.13
31 March 2022	171.90	178.40
31 March 2023	255.52	257.88

The fair value of option has been done by an independent firm of professional valuers on the date of grant using the Black-Scholes Merton Model.

Weighted average fair value of options granted under RR Kabel Limited Employee Stock Option Plan 2023 are as follows :

Grant date	Option Value per unit granted	
	Term based	Performance based
31 March 2023	254.33	257.88

(C) The Key assumptions in the Black-Scholes Merton Model for calculating fair value as on the date of grant :

Particulars	1 April 2021	1 June 2021	30 September 2021	31 March 2022	31 March 2023
Risk Free Rate	5.58%	5.70%	5.63%	6.20%	7.10%
Discount for lack of marketability	22.00%	22.00%	22.00%	22.00%	10.00%
Implied EV/EBITDA multiple and calibration factor	1.0x	1.0x	1.0x	1.0x	1.0x

R R KABEL LIMITED
Annexure VI - Notes to Restated Consolidated Financial Information

(D) Movement of Options Granted :	As at 30 June 2023	As at 30 June 2022	As at 31 March 2023	As at 31 March 2022	As at 31 March 2021
	No. of options	No. of options	No. of options	No. of options	No. of options
Outstanding at the beginning of the period / year	4,51,960	4,81,520	4,81,520	2,59,184	-
Granted during the period / year	-	-	1,55,600	4,81,520	518,360
Exercised during the period / year	-	-	-	-	-
Options expired (due to resignation)	29,640	-	1,85,160	2,59,184	259,176
Outstanding at the end of the period /year	4,22,320	4,81,520	4,51,960	4,81,520	259,184
Options exercisable at the end of the period /year				-	-

Grant date	Exercise price per share option (in ₹)
01 April 2021	270.10
01 June 2021	270.10
30 September 2021	337.50
31 March 2022	337.50
31 March 2023	450.00

(E) Break up of employee stock option expense

Particulars	As at 30 June 2023	As at 30 June 2022	As at 31 March 2023	As at 31 March 2022	As at 31 March 2021
Term based options	1.54	1.42	2.60	3.71	1.15
Performance based options	1.54	1.44	2.54	3.81	1.13
Total	3.08	2.86	5.14	7.52	2.28

Note 49 : Undisclosed Income

There has been no undisclosed income during the year in the tax assessments under the Income Tax Act, 1961 (such as, search or survey or any other relevant provisions of the Income Tax Act, 1961), also there are no previously unrecorded income or related assets which are required to be recorded in the books of account during the period /year.

Note 50: Amalgamation of Ram Ratna Electricals Limited with the Company

- (a) The Scheme of Amalgamation of Ram Ratna Electricals Limited (RREL) (referred to as ‘transferor company’) with R R Kabel Limited (‘the Scheme’), was approved by the National Company Law Tribunal, Mumbai Bench vide their orders dated August 19, 2020. The Company had carried out the accounting prescribed in the Scheme and made the required disclosure for Amalgamations in the nature of merger, as required under Appendix C of Ind AS 103 Business Combinations, for Business Combinations of entities under “Common Control” and accordingly given effect in the financial statements for the year ended 31 March 2020. RREL is engaged in the business of manufacturing, trading and otherwise dealing in consumer electricals, such as fans and lights, and consumer appliances such as water heaters, heat convectors, electric irons and switches and similar products.
- (b) In accordance with the Scheme, the Company had taken over all the assets aggregating to ₹ 1,143.2 Millions, liabilities aggregating to ₹ 1,121.14 Millions and other equity amounting to ₹ (1,10.14) Millions at their respective book values against capital issuance of ₹ 7.15 Millions to the shareholders of RREL as on the appointed date, the resultant surplus of ₹ 125.05 Millions has been credited to capital reserve.

In terms of the Scheme, the Company has allotted 5,28,798 equity shares of ₹ 10 each and 1,40,568 Compulsory convertible preference shares of ₹ 1,080.33 each to existing shareholders of RREL based on share entitlement ratio as per the Scheme.

Note 51 : Business acquisition

The Company has acquired Home Electric Business (HEB) from Luminous Power Technologies Private Limited through business transfer agreement dated 12 April 2022 along with management control on 1 May 2022.

The Company has accounted for the transaction under Ind AS 103, “Business combination” and allocated the aggregate purchase price to identifiable assets acquired and liabilities assumed. The difference being the excess of net assets value is credited to Capital Reserve. the details of such allocation is provided below :

R R KABEL LIMITED
Annexure VI - Notes to Restated Consolidated Financial Information

₹ in millions

Particulars	Amount
Non-current assets	
Property, Plant and Equipment	268.95
Other Intangible assets	66.68
Total non current assets	335.63
Current Assets	
Inventories	706.75
Financial Assets	-
Trade receivables	581.90
Cash and cash equivalents	0.01
Loans	2.85
Other current assets	65.04
Total current assets	1,356.55
TOTAL ASSETS (A)	1,692.18
Current liabilities	
Trade payables	
- total outstanding dues of micro enterprises and small enterprises	-
- total outstanding dues of creditors other than micro enterprises and small enterprises	317.54
Other financial liabilities	40.81
Provisions	70.84
Total Current liabilities	429.19
Total liabilities (B)	429.19
Net Assets (A-B)	1,262.99
Purchase consideration	1,095.83
Total Capital Reserve	167.16

For the period ended 30 June 2022, revenue from operations and loss before tax for the period from 1 May 2022 to 30 June 2022 pertaining to the business acquired from Luminous Power Technologies Private Limited (LPTPL) on 1 May 2022 is Rs 372.21 millions and Rs 116.48 million respectively.

For the year ended 31 March 2023, the Company has upgraded its ERP system with effect from 1 January 2023 wherein the details with respect to adjustment made to revenue from operations such as schemes and discounts, etc and profit or loss before tax pertaining to such business is not maintained separately. Accordingly, it is impracticable to determine revenue from operations and profit or loss before tax for such business acquired separately for the full period from 1 May 2022 to 31 March 2023 and hence the same has not been disclosed.

Further, revenue from operations and profit or loss before tax for such business acquired before the date of acquisition is not available with the Company and hence the combined revenue from operations and profit or loss before tax of the Company assuming the business combination had occurred from the beginning of the applicable reporting period i.e. 1 April 2022 is impracticable to compute and not been disclosed for the period ended 30 June 2022 and year ended 31 March 2023.

Note 52 : Utilization of borrowed funds

No funds have been advanced or loaned or invested (either from borrowed funds or share premium or any other sources or kind of funds) by the Company to or in any other person(s) or entity(ies), including foreign entities ("Intermediaries") with the understanding, whether recorded in writing or otherwise, that the Intermediary shall lend or invest in party identified by or on behalf of the Company (Ultimate Beneficiaries) or provide any guarantee, security or the like on behalf of the Ultimate Beneficiaries. The Company has not received any fund from any party(s) (Funding Party) with the understanding that the Company shall whether, directly or indirectly lend or invest in other persons or entities identified by or on behalf of the Company ("Ultimate Beneficiaries") or provide any guarantee, security or the like on behalf of the Ultimate Beneficiaries.

R R KABEL LIMITED
Annexure VI - Notes to Restated Consolidated Financial Information

Note 53 : FORM AOC-I: Statement containing salient features of the financial statements of Subsidiaries and Joint Ventures (Pursuant to section 129(3) of the Act read with rule 5 of Companies (Accounts) Rules, 2014)

Joint Venture

Particulars	For the period ended 30 June 2023	For the period ended 30 June 2022	For the year ended 31 March 2023	For the year ended 31 March 2022	For the year ended 31 March 2021
i) Name of Joint Venture	RR-Imperial Electricals Ltd.	RR-Imperial Electricals Ltd.	RR-Imperial Electricals Ltd.	RR-Imperial Electricals Ltd.	RR-Imperial Electricals Ltd.
ii) Latest audited balance sheet date	30-Jun-23	30-Jun-22	31-Mar-23	31-Mar-22	31-Mar-21
iii) Date on which acquired	35% investment on various dates	35% investment on various dates	35% investment on various dates	35% investment on various dates	35% investment on various dates
iv) Shares of Joint Ventures held by the Company					
No. of Equity shares	2,21,90,854	2,21,90,854	2,21,90,854	2,21,90,854	2,21,90,854
Amount of Investment in Joint Venture (₹ in Millions)	163.73	163.73	163.73	163.73	163.73
Extent of Holding %	35%	35%	35%	35%	35%
v) Description of how there is Significant influence :-	Joint venture	Joint venture	Joint venture	Joint venture	Joint venture
vi) Reason Why Associate/Joint Venture not Consolidated :-	Consolidated	Consolidated	Consolidated	Consolidated	Consolidated
vii) Net worth* attributable to Shareholding as per latest audited balance sheet (₹ in Millions)	200.39	206.16	196.29	216.36	171.43
viii) Profit for the period/year :-					
Considered in consolidation (₹ in Millions)	6.66	(1.83)	9.44	41.97	10.98
Not considered in consolidation	NIL	NIL	NIL	NIL	NIL

*Net worth includes share capital and other equity of joint venture.

1. Names of joint venture which are yet to commence operations- NIL

2. Names of joint venture entity which have been liquidated or sold during the year-NIL

Note 54 : Details of Joint venture

1) Name of Entity RR-Imperial Electricals Limited

Subsidiary/ Joint Arrangement	Joint venture
Country of Incorporation	Bangladesh
Method used to account for the Investment	Under equity method
% of Holding as on	
30 June 2023	35%
30 June 2022	35%
31 March 2023	35%
31 March 2022	35%
31 March 2021	35%

2) Interest in a Joint venture

The following tables illustrates the summarized financial information of joint venture:

(₹ in Millions)

Particulars	Joint venture				
	As at 30 June 2023	As at 30 June 2022	As at 31 March 2023	As at 31 March 2022	As at 31 March 2021
Current Assets	907.02	1,061.94	867.86	1,104.18	902.91
Non-Current Assets	398.69	488.20	397.18	493.89	486.45
Current Liabilities	659.91	846.12	613.08	879.35	790.97
Non-Current Liabilities	73.27	114.99	91.13	100.58	108.60
Equity	572.54	589.02	560.84	618.14	489.80
Proportion of the Company's ownership interest	0.35	0.35	0.35	0.35	0.35
Carrying amount of the Company's interest before consolidation adjustments	200.39	206.16	196.29	216.35	171.43
Less : adjustments on Consolidation	-	-	-	-	-
Carrying amount of the Company's interest	200.39	206.16	196.29	216.35	171.43

(₹ in Millions)

Particulars	Joint venture				
	For the period ended	For the period ended	For the year ended	For the year ended	For the year ended
	30 June 2023	30 June 2022	31 March 2023	31 March 2022	31 March 2021
Revenue	422.00	524.69	1,654.59	1,754.68	951.05
Interest Income	0.32	0.17	1.43	1.12	2.12
Cost of raw material and components consumed	322.65	319.60	1,079.18	1,150.92	832.07
Changes in Inventories	(3.29)	53.00	134.49	108.05	(182.31)
Depreciation and amortization expense	7.14	11.00	35.33	43.51	44.43
Finance cost	16.13	25.88	68.48	43.11	34.71
Employee benefits expense	26.48	26.85	97.72	111.73	91.56
Other expenses	32.06	90.88	202.85	120.71	82.04
Profit before tax	21.17	(2.35)	37.99	177.76	50.68
Income tax expense	2.13	2.88	11.01	57.89	19.28
Profit for the year	19.04	(5.23)	26.98	119.87	31.40
Other Comprehensive Income	-	-	-	-	-
Total Comprehensive Income	19.04	(5.23)	26.98	119.87	31.40
Company's share of loss for the period/year	6.66	(1.83)	9.44	41.97	10.98
Less: adjustment on Consolidation	-	-	-	-	-
Total Comprehensive Income on consolidation	6.66	(1.83)	9.44	41.97	10.98
Company's share of other comprehensive income for the period/year	-	-	-	-	-
Company's total comprehensive income for the period/year	6.66	(1.83)	9.44	41.97	10.98
Dividend received from Joint venture during the period/year	-	-	-	-	-

Note : Customary type of letters of credit (LCs) amounting to ₹ 93.05 and ₹ 90.64 millions pertaining to Joint venture, disclosed as contingent liability under the note for “Details of Joint Venture” in the Consolidated Financial Statement for the year ended 31 March 2021 and 31 March 2022 respectively, is not contingent liability in accordance with requirements prescribed in guidance note to Schedule III Division II. The same has now been restated.

Note 55 : Disclosure of additional information pertaining to the Company and Joint venture as per Schedule III of Companies Act, 2013

(₹ in Millions)

Name of Company	Net Assets (Total Assets minus Total Liabilities)		Share in Profit and Loss before tax		Share in Other Comprehensive Income		Share in Total Comprehensive Income	
	As at 30 June 2023		For the period ended 30 June 2023		For the period ended 30 June 2023		For the period ended 30 June 2023	
	As % of Consolidated Net Assets	Amount	As % of Consolidated Profit or Loss	Amount	As % of Consolidated OCI	Amount	As % of Consolidated TCI	Amount
Company								
R R Kabel Limited	98.69%	15,038.69	99.33%	987.22	101%	298.04	99.61%	1,034.86
Joint Venture								
RR-Imperial Electricals Ltd.	1.31%	200.39	0.67%	6.66	-1%	(2.57)	0.39%	4.09
TOTAL	100.00%	15,239.08	100.00%	993.88	100.00%	295.47	100.00%	1,038.95

(₹ in Millions)

Name of Company	Net Assets (Total Assets minus Total Liabilities)		Share in Profit and Loss before tax		Share in Other Comprehensive Income		Share in Total Comprehensive Income	
	As at 30 June 2022		For the period ended 30 June 2022		For the period ended 30 June 2022		For the period ended 30 June 2022	
	As % of Consolidated Net Assets	Amount	As % of Consolidated Profit or Loss	Amount	As % of Consolidated OCI	Amount	As % of Consolidated TCI	Amount
Company								
R R Kabel Limited	98.39%	12,596.02	100.74%	248.06	83.99%	(43.92)	107.90%	139.33
Joint Venture								
RR-Imperial Electricals Ltd.	1.61%	206.16	-0.74%	(1.83)	16.01%	(8.37)	-7.90%	(10.20)
TOTAL	100.00%	12,802.18	100.00%	246.23	100.00%	(52.29)	100.00%	129.13

(₹ in Millions)

Name of Company	Net Assets (Total Assets minus Total Liabilities)		Share in Profit and Loss before tax		Share in Other Comprehensive Income		Share in Total Comprehensive Income	
	As at 31 March 2023		For the year ended 31 March 2023		For the year ended 31 March 2023		For the year ended 31 March 2023	
	As % of Consolidated Net Assets	Amount	As % of Consolidated Profit or Loss	Amount	As % of Consolidated OCI	Amount	As % of Consolidated TCI	Amount
Company								
R R Kabel Limited	98.62%	14,000.66	99.63%	2,550.47	124.03%	152.32	100.99%	2,041.60
Joint Venture								
RR-Imperial Electricals Ltd.	1.38%	196.29	0.37%	9.44	-24.03%	(29.51)	-0.99%	(20.07)
TOTAL	100.00%	14,196.95	100.00%	2,559.91	100.00%	122.81	100.00	2,021.53

(₹ in Millions)

Name of Company	Net Assets (Total Assets minus Total Liabilities)		Share in Profit and Loss before tax		Share in Other Comprehensive Income		Share in Total Comprehensive Income	
	As at 31 March 2022		For the year ended 31 March 2022		For the year ended 31 March 2022		For the year ended 31 March 2022	
	As % of Consolidated Net Assets	Amount	As % of Consolidated Profit or Loss	Amount	As % of Consolidated OCI	Amount	As % of Consolidated TCI	Amount
Company								
R R Kabel Limited	98.27%	12,286.67	98.52%	2,801.62	98.23%	164.54	98.05%	2,261.94
Joint Venture								
RR-Imperial Electricals Ltd.	1.73%	216.36	1.48%	41.97	1.77%	2.96	1.95%	44.93
TOTAL	100.00%	12,503.03	100.00%	2,843.59	100.00%	167.50	100.00%	2,306.87

Name of Company	Net Assets (Total Assets minus Total Liabilities)		Share in Profit and Loss before tax		Share in Other Comprehensive Income		Share in Total Comprehensive Income	
	As at 31 March 2021		For the year ended 31 March 2021		For the year ended 31 March 2021		For the year ended 31 March 2021	
	As % of Consolidated Net Assets	Amount	As % of Consolidated Profit or Loss	Amount	As % of Consolidated OCI	Amount	As % of Consolidated TCI	Amount
Company								
R R Kabel Limited	98.36%	10,294.88	99.39%	1,803.36	106.54%	76.58	99.56%	1,419.58
Joint Venture								
RR-Imperial Electricals Ltd.	1.64%	171.43	0.61%	10.98	-6.54%	-4.70	0.44%	6.28
TOTAL	100.00%	10,466.31	100.00%	1,814.34	100.00%	71.88	100.00%	1,425.86

Note 56 : Other statutory disclosures

- i) The Company has not traded or invested in Crypto currency or Virtual Currency during reporting periods.
- ii) The Company has complied with the number of layers prescribed under clause (87) of section 2 of the Act read with Companies (Restriction on number of Layers) Rules, 2017.
- iii) The Company is not declared as a wilful defaulter by any bank or financial institution or other lender during the any reporting period.
- iv) Section 8 of the Companies Act, 2013 company is required to disclose grants or donations received during the year. Since, the company is not covered under Section 8 of the Companies Act, 2013, the said disclosure is not applicable.

R R KABEL LIMITED

Annexure VI - Notes to Restated Consolidated Financial Information

As per our Report of even date

For B S R & Co. LLP

Chartered Accountants

Firm Registration No: 101248W/W-100022

For and on behalf of the Board of Directors of

R R Kabel Limited

CIN: U28997MH1995PLC085294

Rupen Shah

Partner

Membership No. 116240

Place: Ahmedabad

Date: 30 August 2023

Tribhuvanprasad Rameshwarlal Kabra

Executive Chairman

DIN : 00091375

Shreegopal Rameshwarlal Kabra

Managing Director

DIN : 00140598

Dinesh Aggarwal

Chief Executive Officer

Himanshu Navinchandra Parmar

Company Secretary

Membership No.FCS 10118

Rajesh Babu Jain

Chief Financial Officer

Membership No. 20811

Place: Mumbai

Date: 30 August 2023

R R KABEL LIMITED

Annexure VII-Statement of Adjustments to the Restated Consolidated Financial information ('RCFI')

(Amount in ₹ millions, except for share data unless otherwise stated)

I Non-adjusting items:

a) Audit qualifications for the respective years, which do not require any adjustments in the restated consolidated Financial Information are as follows:

There are no audit qualification in auditor's report for the three month periods ended 30 June 2023, 30 June 2022 and years ended 31 March 2023, 31 March 2022 and 31 March 2021 respectively.

b) Auditor's Comment in Annexure to Auditors' Report, which do not require any corrective adjustments in the Consolidated Restated Financial Information

In addition to the audit opinion on the consolidated financial statements, the auditors are required to comment upon the matters included in the Companies (Auditor's Report) Order, 2020 Companies (Auditor's Report) Order, 2016 (together, the "CARO Report") issued by the Central Government of India under sub-section (11) of Section 143 of Companies Act, 2013 on the standalone financial statements as at and for the financial years ended 31 March 2021, 31 March 2022 and 31 March 2023 respectively and consolidated financial statements for the year ended 31 March 2023 and 31 March 2022. Certain statements/comments included in the CARO in the consolidated and standalone financial statements, which do not require any adjustments in the Restated Consolidated Financial Information are reproduced below in respect of the financial statements presented.

For the year ended 31 March 2023

Clause (i)(c) of CARO 2020 Order

According to the information and explanations given to us and on the basis of our examination of the records of the Company, the title deeds of immovable properties (other than immovable properties where the Company is the lessee and the lease agreements are duly executed in favour of the lessee) are held in the name of the Company, except for the following which are not held in the name of the Company:

Description of property	Gross carrying value (₹ in Millions)	Held in the name of	Whether promoter director or their relative or employee	Period held indicate range where appropriate	Reason for not being held in the name of the Company. Also indicate if in dispute
Building located at Howrah	36.42	Goldline Vyapaar Private Limited	No	2017	Title deed yet to be executed in the name of the Company.
Freehold land located at Roorkee	14.73	Ram Ratna Electricals Limited	No	2020	The title deed is in the name of erstwhile company that was amalgamated with the Company w.e.f. 01 April 2019 pursuant to scheme of Amalgamation sanctioned by Hon'ble Bombay High Court.
Factory building located at Roorkee	9.51	Ram Ratna Electricals Limited	No	2020	The title deed is in the name of erstwhile company that was amalgamated with the Company w.e.f. 01 April 2019 pursuant to scheme of Amalgamation sanctioned by Hon'ble Bombay High Court.

The above comment was also included under clause (i)(c) in annexure to audit report on the Consolidated Financial Statements for the year ended 31 March 2023.

Clause (ii)(b) of CARO 2020 Order

According to the information and explanations given to us and on the basis of our examination of the records of the Company, the Company has been sanctioned working capital limits in excess of five crore rupees, in aggregate, from banks or financial institutions on the basis of security of current assets. In our opinion, the quarterly returns or statements filed by the Company with such banks or financial institutions are in agreement with the books of account of the Company except as follows:

(₹ in Millions)

Name of Bank	Quarter	Particulars	For the year ended 31 March 2023			
			Amounts as per the Books of Accounts	Amounts as reported in the Quarterly Return Statement	Amounts of Difference	Whether return/ statement subsequently rectified
DBS BANK, HDFC BANK, HSBC BANK KOTAK BANK STATE BANK OF INDIA SCB BANK	1	Inventory	6,655.13	6,647.85	(7.28)	Yes
		Trade Receivable	7,260.59	6,978.61	(281.98)	Yes
		Trade payable	2,234.20	1,830.34	(403.86)	Yes
	2	Inventory	5,755.02	5,752.79	(2.23)	Yes
		Trade Receivable	7,480.45	7,480.36	(0.09)	Yes
		Trade payable	1,892.73	1,892.79	0.06	Yes
	3	Inventory	5,443.64	5,441.59	(2.05)	Yes
		Trade Receivable	8,144.50	8,144.60	0.10	Yes

R R KABEL LIMITED**Annexure VII-Statement of Adjustments to the Restated Consolidated Financial information ('RCFI')**

(Amount in ₹ millions, except for share data unless otherwise stated)

Clause (vii)(a)

The Company does not have liability in respect of Service tax, Duty of excise, Sales tax and Value added tax during the year since effective 1 July 2017, these statutory dues has been subsumed into GST. According to the information and explanations given to us and on the basis of our examination of the records of the Company, in our opinion amounts deducted / accrued in the books of account in respect of undisputed statutory dues including Goods and Service Tax, Provident Fund, Employees State Insurance, Income-Tax, Duty of Customs or Cess or other statutory dues have generally been regularly deposited with the appropriate authorities, though there have been slight delays in a few cases of Income Tax, Provident Fund and Professional Tax.

According to the information and explanations given to us and on the basis of our examination of the records of the Company, no undisputed amounts payable in respect of Goods and Service Tax, Provident Fund, Employees State Insurance, Income-Tax, Duty of Customs or Cess or other statutory dues were in arrears as at 31 March 2023 for a period of more than six months from the date they became payable.

Clause (vii)(b)

According to the information and explanations given to us and on the basis of our examination of the records of the Company, statutory dues relating to Goods and Service Tax, Provident Fund, Employees State Insurance, Income-Tax, Duty of Customs, Sales Tax, Services Tax and Duty of Excise or Cess or other statutory dues which have not been deposited on account of any dispute are as follows:

Name of the statute	Nature of the dues	Amount involved (₹ in Millions)	Amount unpaid (₹ in Millions)	Period to which the amount relates	Forum where dispute is pending
The finance Act, 1994	Service tax, Interest and penalty	21.16	18.05	Various periods from 2009-10 to 2017-18	Commissioner Excise and service tax Appellate Tribunal (CESTAT)
The finance Act, 1994	Service tax, Interest and penalty	2.08	2.08	Various periods from 2011-12 to 2020-21	Joint Commissioner Superintendent Central Excise & service tax Appellate Tribunal (CESTAT)
The Income Tax Act, 1961	Tax and Interest	31.74	31.74	Various periods from 2008-09 and 2019-20	Commissioner of Income Tax Appeals CIT(A)
The Income Tax Act, 1961	Tax and Interest	0.81	0.64	2017-18	Assistant Commissioner of Income Tax Appeal CIT (A)
Sales Tax Act	Sales Tax	97.33	97.33	Various periods from 2013-14 to 2017-18	Joint Commissioner Value Added Tax
The Goods and Service Tax, 2017	Tax, Interest and penalty	59.49	27.61	2017-18	Joint Commissioner Central Goods and Service Tax, Vadodara
Industrial Dispute Act, 1947	Wages	2.06	1.86	FY 2016-17 to FY 2022-23	Industrial Tribunal Court, Vadodara.

For the year ended 31 March 2022**Clause (i)(c) of CARO 2020 Order**

According to the information and explanations given to us and on the basis of our examination of the records of the Company, the title deeds of immovable properties (other than immovable properties where the Company is the lessee and the lease agreements are duly executed in favour of the lessee) are held in the name of the Company, except for the following which are not held in the name of the Company:

Description of property	Gross carrying value (₹ in Millions)	Held in the name of	Whether promoter director or their relative or employee	Period held indicate range where appropriate	Reason for not being held in the name of the Company. Also indicate if in dispute
Building located at Howrah	36.42	Goldline Vyapaar Private Limited	No	2017	Title deed yet to be executed in the name of the Company.
Freehold land located at Roorkee	14.73	Ram Ratna Electricals Limited	No	2020	The title deed is in the name of erstwhile company that was amalgamated with the Company w.e.f. 01 April 2019 pursuant to scheme of Amalgamation sanctioned by Hon'ble Bombay High Court.
Factory building located at Roorkee	9.51	Ram Ratna Electricals Limited	No	2020	The title deed is in the name of erstwhile company that was amalgamated with the Company w.e.f. 01 April 2019 pursuant to scheme of Amalgamation sanctioned by Hon'ble Bombay High Court.

The above comment was also included under clause (i)(c) in annexure to audit report on the Consolidated Financial Statements for the year ended 31 March 2022.

R R KABEL LIMITED**Annexure VII-Statement of Adjustments to the Restated Consolidated Financial information ('RCFI')**

(Amount in ₹ millions, except for share data unless otherwise stated)

Clause (vii)(a)

The Company does not have liability in respect of Service tax, Duty of excise, Sales tax and Value added tax during the year since effective 1 July 2017, these statutory dues has been subsumed into GST. According to the information and explanations given to us and on the basis of our examination of the records of the Company, in our opinion amounts deducted / accrued in the books of account in respect of undisputed statutory dues including Goods and Service Tax, Provident Fund, Employees State Insurance, Income-Tax, Duty of Customs or Cess or other statutory dues have generally been regularly deposited with the appropriate authorities, though there have been slight delays in a few cases of Income Tax, Provident Fund and Professional Tax.

According to the information and explanations given to us and on the basis of our examination of the records of the Company, no undisputed amounts payable in respect of Goods and Service Tax, Provident Fund, Employees State Insurance, Income-Tax, Duty of Customs or Cess or other statutory dues were in arrears as at 31 March 2022 for a period of more than six months from the date they became payable.

Clause (vii)(b)

According to the information and explanations given to us and on the basis of our examination of the records of the Company, statutory dues relating to Goods and Service Tax, Provident Fund, Employees State Insurance, Income-Tax, Duty of Customs, Sales Tax, Services Tax and Duty of Excise or Cess or other statutory dues which have not been deposited on account of any dispute are as follows:

Name of the statute	Nature of the dues	Amount involved (₹ in Millions)	Amount unpaid (₹ in Millions)	Period to which the amount relates	Forum where dispute is pending
The finance Act, 1994	Service tax, Interest and penalty	19.04	15.93	Various periods from 2010-11 to 2018-19	Commissioner Excise and service tax Appellate Tribunal (CESTAT)
The finance Act, 1994	Service tax, Interest and penalty	1.90	1.90	2012-13 to 2015-16	Superintendent of Central Excise & Customs
The Income Tax Act, 1961	Tax and Interest	21.96	21.76	2017-18 and 2018-19	Commissioner of Income Tax Appeals CIT(A)
Sales Tax Act	Sales Tax	95.36	95.36	2012-13, 2014-15 and 2015-16	Joint Commissioner Value Added Tax
The Goods and Service Tax, 2017	Tax, Interest and penalty	0.29	0.29	2017-18	Superintendent, Audit Group-8, CGST & Central Excise Audit Commissionerate, Surat.
Industrial Dispute Act, 1947	Wages	1.76	1.56	February 2017 to March 2022	Industrial Tribunal Court, Vadodara.

For the year ended 31 March 2021**Clause (i) (c)**

In our opinion and according to the information and explanations given to us and on the basis of our examination of records of the Company, we report that, the title deeds of immovable properties of freehold land and building are held in the name of the Company except the following :-

(₹ in Millions)

Particular	Gross block as on 31 March 2021	Net block as on 31 March 2021	Remarks
Freehold land located in Howrah	11.15	11.15	Title deed yet to be Executed in name of the Company
Building located in Howrah	36.42	36.42	Title deed yet to be Executed in name of the Company
Freehold land located in Roorkee	14.73	14.73	Title deed is in name of erstwhile Company that was amalgamated with the Company pursuant to scheme of amalgamation sanctioned by Hon'ble Bombay High Court.
Factory building located in Roorkee	9.51	9.51	Title deed is in name of erstwhile Company that was amalgamated with the Company pursuant to scheme of amalgamation sanctioned by Hon'ble Bombay High Court.

Clause (vii) (a)

According to the information and explanations given to us and on the basis of our examination of the records of the Company, amounts deducted / accrued in the books of account in respect of undisputed statutory dues including provident fund, professional tax, employees' state insurance, income tax, duty of customs, goods and services tax, cess and any other material statutory dues have generally been regularly deposited during the year by the Company with appropriate authorities, though there has been slight delays in few cases. As explained to us, the company did not have any dues on account of wealth tax, sales tax, service tax, duty of excise and value added tax during the year.

R R KABEL LIMITED
Annexure VII-Statement of Adjustments to the Restated Consolidated Financial information ('RCFI')

(Amount in ₹ millions, except for share data unless otherwise stated)

According to the information and explanations given to us, no undisputed amounts payable in respect of provident fund, professional tax, employees' state insurance, income tax, duty of customs, goods and service tax, cess and other material statutory dues were in arrears as at 31 March 2020 for a period of more than six months from the date they became payable. In respect of provident fund, as explained in Note 28 to the Consolidated Financial Statements, the management has not accounted any additional liability with respect to Supreme Court's judgement over provident fund, considering uncertainty around the timing, manner and extent in which the judgment will be interpreted and applied by the regulatory authorities. Accordingly, we are unable to comment on such provident fund arrears, if any with respect to outstanding as at 31 March 2020 for a period of more than six months from the date they become payable.

Clause (vii) (b)

According to the information and explanations given to us, there are no dues of provident fund, professional tax, Employees' State Insurance, Income Tax, Sales Tax, Service Tax, Duty of Customs, Duty of Excise, Value Added Tax, Goods and Services Tax, Cess and other material statutory dues which have not been deposited with the appropriate authorities on account of any dispute other than those as stated below:

(₹ in Millions)

Nature of the Statute	Nature of dues	Amount involved	Amount Unpaid	Period to which the amount relates (AY)	Forum where matter is pending
The finance Act, 1994	Service tax, Interest and penalty	19.04	15.93	Various periods from 2010-11 to 2018-19	Commissioner Excise and service tax Appellate Tribunal (CESTAT)
		1.84	1.84	2012-13 to 2015-16	Superintendent of Central Excise & Customs
The Income Tax Act, 1961	Tax and Interest	23.11	21.76	2017-18 and 2018-19	Commissioner of Income Tax Appeals CIT(A)
Sales Tax Act	Sales Tax	99.86	99.86	2012-13, 2014-15 and 2015-16	Joint Commissioner Value Added Tax

II Adjusting items:

Appropriate regroupings and reclassification have been made in the Restated Consolidated Balance Sheet, Restated Consolidated Statement of Profit and Loss and Restated Consolidated Statement of Cash Flow, wherever required, by reclassification of the corresponding items of income, expenses, assets, liabilities and cashflows, in order to bring them in line with the accounting policies and classification as per Ind AS financial information of the Company for the three months period ended 30 June 2023, 30 June 2022 and year ended 31 March 2023, 31 March 2022, 31 March 2021, prepared in accordance with Schedule III of Companies Act, 2013, requirements of Ind AS 1 and other applicable Ind AS principles and the requirements of the Securities and Exchange Board of India (Issue of Capital & Disclosure Requirements) Regulations 2018, as amended. The summary of such changes are described as under:

A Restatement to the Statement of Assets and Liabilities, Statement of Profit and Loss and Statement of Cash Flow

Pursuant to amendment in Schedule III to the Companies Act, 2013, effective from 1 April 2021, the Company has restated the classification of security deposits from "Loans" to "Other financial assets" and Current maturities of long-term borrowings from "Other financial liabilities" to "Current financial liabilities - Borrowings".

Restatement adjustments in Restated Consolidated Statement of Assets and Liabilities

(₹ in millions)

Particulars	31 March 2022			31 March 2021		
	As per earlier reported	Revised classification	Restatement adjustment	As per earlier reported	Revised classification	Restatement adjustment
Assets						
Non current assets						
Financial Assets						
Loans	-	-	-	16.06	0.52	(15.54)
Others	-	-	-	0.80	21.72	20.92
Current assets						
Financial Assets						
Loans	-	-	-	16.42	2.20	(14.22)
Others	-	-	-	24.80	118.97	94.17
Liabilities						
Current liabilities						
Financial liabilities						
Borrowings	-	-	-	3,949.85	4,609.20	(659.35)
Other financial liabilities						
Current maturities of long term borrowing				315.68	-	315.68

R R KABEL LIMITED
Annexure VII-Statement of Adjustments to the Restated Consolidated Financial information ('RCFI')

(Amount in ₹ millions, except for share data unless otherwise stated)

B Other restatement adjustments

1) The company has disclosed below notes in the Restated Consolidated Financial Information pursuant to amendment in Schedule III to the Companies Act, 2013, effective from 1 April 2021 for the years ended 31 March 2021:

- Ageing schedule for Capital-work-in progress and expected capitalization period for projects which are delayed or have exceeded their costs as compared to budgeted (Note 2 to RCFI).
- Ageing schedule for Intangible Assets under Development (Note 2 to RCFI)
- Trade Receivables ageing schedule (Note 9 to RCFI)
- Details of shares held by promoters and change in the shareholding (Note 11 to RCFI)
- Reconciliation of quarterly submission of bank returns / stock statements filed by the Company with its bankers with books of account (Note 13 to RCFI)
- Trade Payables ageing schedule (Note 19 to RCFI)
- Corporate social responsibility expenses disclosure (Note 32 to RCFI)
- Transactions with stuck off companies (Note 34 to RCFI)

2) Restatements in disclosures provided for related party transactions and outstanding balances (Note 33 to RCFI) :

₹ in Millions

Particulars	31 March 2022			31 March 2021		
	As per earlier reported	Revised classification	Restatement adjustment	As per earlier reported	Revised classification	Restatement adjustment
Commission (a)						
Bhagwat Singh Babel	-	-	-	-	0.40	0.40
Ramamirtham Kannan	-	-	-	-	0.40	0.40
Mukund Chitale	-	-	-	-	0.40	0.40
Managerial Remuneration (b)						
Partha Chakraborti	-	-	-	-	-	-
Himanshu Parmar	-	-	-	-	-	-
Reimbursement paid (c)						
Shreegopal Kabra	-	-	-	-	-	-
Personal Guarantee outstanding for (d)						
<u>Secured borrowings</u>						
Tribhuvanprasad Kabra						
Mahendrakumar Kabra						
Shreegopal Kabra	-	-	-	6,250.00	5,059.26	(1,190.74)
Mahhesh Kabra						
Sumeet Kabra						
<u>Unsecured borrowings</u>						
Tribhuvanprasad Kabra						
Mahendrakumar Kabra						
Shreegopal Kabra	-	-	-	2,135.00	330.55	(1,804.45)
Mahhesh Kabra						
Sumeet Kabra						
Transactions with Joint Venture (RR-Imperial Electricals Limited) (e)						
Sale of goods	-	80.99	80.99	-	103.35	103.35
Balances outstanding of Joint Venture (RR-Imperial Electricals Limited) (e)						
Trade Receivables	-	39.84	39.84	-	55.57	55.57
Purchases: Goods and Services (f)						
Ram Ratna International	46.27	20.42	(25.85)	23.88	1.88	(22.01)
Interest (f)						
TMG Global Fzco.	-	-	-	3.17	-	(3.17)
Trade Payable (f)						
Ram Ratna International	39.51	31.61	(7.90)	34.23	19.86	(14.37)
Dividend Paid (g)						
Others	0.30	9.33	9.03	-	-	-

R R KABEL LIMITED

Annexure VII-Statement of Adjustments to the Restated Consolidated Financial information ('RCFI')

(Amount in ₹ millions, except for share data unless otherwise stated)

Footnotes for restatements under related party disclosure

- a) Commission to independent directors was not considered in the note provided in the Consolidated Financial Statement for the year ended 31 March 2021 which is now disclosed.
 - b) Personal guarantee of directors of the Company was disclosed in the Consolidated Financial Statement for the year ended 31 March 2021 to the extent of total sanctioned limits of applicable borrowings instead of actual exposure as at 31 March 2021 which has now been restated.
 - c) Disclosure for transactions with and balance outstanding of Joint Venture of the Company was not included under Related Party Disclosure in the Consolidated Financial Statements for the years ended 31 March 2022, 31 March 2021 which has now been restated.
 - d) Purchases, interest expenses and trade payable balance pertaining to transactions of joint venture with mutual related parties of the Company earlier included are now excluded and restated
 - e) Amount of dividend paid was not included/inadvertently included in the disclosure is now restated.
- 3) Other immaterial changes made in the restated consolidated financial statement have been explained wherever necessary under respective schedules.
- 4) There are no differences in other equity and statement of profit and loss as per audited Consolidated Financial Statements and the Restated Consolidated Financial Information for respective years and hence the same is not disclosed.

OTHER FINANCIAL INFORMATION

The accounting ratios derived from Restated Consolidated Financial Information required to be disclosed under the SEBI ICDR Regulations are set forth below:

Particulars	Three months ended June 30*,		As at/ for the Fiscal ended March 31,		
	2023	2022	2023	2022	2021
Basic Earnings per Equity Share (in ₹) ^{(1) (2) (3) (4)}	6.69	1.63	17.09	19.26	12.19
Diluted Earnings per Equity Share (in ₹) ^{(1) (2) (3) (4)}	6.68	1.63	17.07	19.22	12.18
Return on Net Worth (%) ^{(5) (6) #}	4.97	1.45	13.66	17.29	13.10
Net Asset Value per Equity Share (in ₹) ^{(4) (7) #}	134.57	112.56	125.19	111.38	93.04
EBITDA ^{(8) #}	1,298.99	471.82	3,577.04	3,537.27	2,532.40

*Not Annualised

These are Non-GAAP Measures. For reconciliation see “– Reconciliation of Non-GAAP Measures” on page 372.

Notes:

- (1) Earnings per Equity Share is calculated as Profit for the period/year divided by Weighted average number of equity shares outstanding during the period/year.
- (2) Basic and diluted earnings per Equity Share are computed in accordance with Indian Accounting Standard 33.
- (3) The basic and diluted Earnings per Equity Share have been calculated/restated after considering sub-division of Equity Shares of face value of ₹10 each to ₹5 each and issue of bonus shares in the ratio of 1 (one) Equity Share for 1(one) Equity Share held on the record date as approved by the Board of Directors and Shareholders in their meeting held on March 16, 2023 and March 20, 2023, respectively. Appropriate adjustments have been made for compulsory convertible preference shares and options granted to employees under the ESOP schemes of the Company.
- (4) The face value of each Equity Share is ₹5.
- (5) Return on Net Worth is calculated as Profit for the period/ year divided by Net Worth at the end of the period/year.
- (6) Net Worth has been defined as restated and consolidated net worth, which is the aggregate value of the paid-up share capital and all reserves created out of the profits and securities premium account and debit or credit balance of profit and loss account, after deducting the aggregate value of the accumulated losses, deferred expenditure and miscellaneous expenditure not written off, as per the restated consolidated statement of assets and liabilities, but does not include reserves created out of revaluation of assets, write-back of depreciation and amalgamation. Further, capital redemption reserve, capital reserve and share suspense account have been excluded when computing other equity since these were not created out of the profits. This a non-GAAP measure. For reconciliation see “Other Financial Information – Reconciliation of Non-GAAP Measures” on page 372.
- (7) Net Asset Value per Equity Share is calculated as Net Worth at the end of the period/year divided by Weighted average number of equity shares outstanding during the period/year.
- (8) EBITDA is calculated as profit for the year/ period plus finance costs plus tax expense plus depreciation and amortization expense.

For reconciliation of non-GAAP measures, see “Reconciliation of Non-GAAP Measures” on page 372.

Non-GAAP Financial Measures

This section includes Certain Non-GAAP financial measures and other statistical information relating to our operations and financial performance (together, “**Non-GAAP Measures**” and each a “**Non-GAAP Measure**”), as presented below. These Non-GAAP financial measures are not required by or presented in accordance with Ind AS.

Further, these Non-GAAP Measures are not a measurement of our financial performance or liquidity under Ind AS and should not be considered in isolation or construed as an alternative to cash flows, profit/ (loss) for the years/ period or any other measure of financial performance or as an indicator of our operating performance, liquidity, profitability or cash flows generated by operating, investing or financing activities derived in accordance with Ind AS. In addition, these Non-GAAP Measures are not standardized terms, hence a direct comparison of these Non-GAAP Measures between companies may not be possible. Other companies may calculate these Non-GAAP Measures differently from us, limiting its usefulness as a comparative measure. Although such Non-GAAP Measures are not a measure of performance calculated in accordance with applicable accounting standards, our Company’s management believes that they are useful to an investor in evaluating us as they are widely used measures to evaluate a company’s operating performance.

Reconciliation of Non-GAAP Measures

Reconciliation for the various Non-GAAP Financial Measures included in this Red Herring Prospectus are given below.

Reconciliation of Net Worth and Return on Net Worth

(₹ in million, except as otherwise stated)

Particulars	Three months ended June 30*		As at/ for the Fiscal ended March 31,		
	2023	2022	2023	2022	2021
Equity share capital (A)	478.48	239.24	478.48	239.24	239.24
Instrument entirely equity in nature (B)	4,151.86	4,151.86	4,151.86	4,151.86	4,151.86
Other equity (C)	10,608.74	8,411.08	9,566.61	8,111.93	6,075.21
Equity (D = A + B + C)	15,239.08	12,802.18	14,196.95	12,503.03	10,466.31
Capital redemption reserve (E)	-	7.51	-	7.51	7.51
Capital reserve (F)	292.21	292.21	292.21	125.05	125.05
Net Worth (G = D - E - F)	14,946.87	12,502.46	13,904.74	12,370.47	10,333.75
Profit for the period/year (H)	743.48	181.42	1,898.72	2,139.37	1,353.98
Return on Net Worth (I = H/D) (%)	4.97	1.45	13.66	17.29	13.10

*Not Annualised

Reconciliation of Net Asset Value per Equity Share

(₹ in million, except as otherwise stated)

Particulars	Three months ended June 30,		As at/ for the Fiscal ended March 31,		
	2023	2022	2023	2022	2021
Equity share capital (A)	478.48	239.24	478.48	239.24	239.24
Instrument entirely equity in nature (B)	4,151.86	4,151.86	4,151.86	4,151.86	4,151.86
Other equity (C)	10,608.74	8,411.08	9,566.61	8,111.93	6,075.21
Equity (D = A + B + C)	15,239.08	12,802.18	14,196.95	12,503.03	10,466.31
Capital redemption reserve (E)	-	7.51	0.00	7.51	7.51
Capital reserve (F)	292.21	292.21	292.21	125.05	125.05
Share suspense account (G)	-	-	-	-	-
Net Worth (H = D - E - F - G)	14,946.87	12,502.46	13,904.74	12,370.47	10,333.75
Weighted average number of equity shares outstanding during the period/year (I)	111,068,856	111,068,856	111,068,856	111,068,856	111,068,856
Net Asset Value per Equity Share (J = H/I) (in ₹)	134.57	112.56	125.19	111.38	93.04

Reconciliation of EBITDA, EBITDA Growth and EBITDA Margin

(₹ in million, except as otherwise stated)

Particulars	Three months ended June 30,		As at/ for the Fiscal ended March 31,		
	2023	2022	2023	2022	2021
Profit for the year/ period (A)	743.48	181.42	1,898.72	2,139.37	1,353.98
Add: Tax expense (B)	250.40	64.81	661.19	704.22	460.36
Add: Finance costs (C)	144.24	80.77	420.86	232.84	270.56
Add: Depreciation and amortization expense (D)	160.87	144.82	596.27	460.84	447.50
EBITDA (E = A + B + C + D)	1,298.99	471.82	3,577.04	3,537.27	2,532.40
EBITDA Growth (%)**	175.31	-	1.12	39.68	9.28
Total Income (F)	16,135.98	12,433.00	56,336.40	44,322.18	27,459.36
EBITDA Margin (G = E/F) (%)	8.05	3.79	6.35	7.98	9.22

*EBITDA growth has not been included as the comparative period has not been included in this Red Herring Prospectus

**EBITDA Growth means (EBITDA of current period/year minus EBITDA of previous period/year) divided by EBITDA of previous period/year.

Reconciliation of PAT Margin

(₹ in million, except as otherwise stated)

Particulars	Three months ended June 30,		As at/ for the Fiscal ended March 31,		
	2023	2022	2023	2022	2021
Profit for the year/period (A)	743.48	181.42	1,898.72	2,139.37	1,353.98
Total Income (B)	16,135.98	12,433.00	56,336.40	44,322.18	27,459.36
PAT Margin (C = A/B) (%)	4.61	1.46	3.37	4.83	4.93

Reconciliation of Tangible Net Worth, Capital Employed and Return on Capital Employed

(₹ in million, except as otherwise stated)

Particulars	Three months ended June 30*		As at/ for the Fiscal ended March 31,		
	2023	2022	2023	2022	2021
Equity share capital (A)	478.48	239.24	478.48	239.24	239.24
Instrument entirely equity in nature (B)	4,151.86	4,151.86	4,151.86	4,151.86	4,151.86
Other equity (C)	10,608.74	8,411.08	9,566.61	8,111.93	6,075.21
Equity (D = A+B+C)	15,239.08	12,802.18	14,196.95	12,503.03	10,466.31
Less: Capital redemption reserve (E)	0.00	7.51	0.00	7.51	7.51
Less: Capital reserve (F)	292.21	292.21	292.21	125.05	125.05
Less: Share suspense account (G)	0.00	0.00	0.00	-	-
Less: Other intangible assets (H)	54.26	96.81	64.86	36.65	52.75
Less: Intangible assets under development (I)	0.00	0.00	0.00	6.00	4.85
Tangible Net Worth (J = D-E-F-G-H-I)	14,892.61	12,405.65	13,839.88	12,327.82	10,276.15
Add: Non-current borrowings (K)	187.49	511.92	268.59	593.13	712.82
Add: Current borrowings (L)	3,850.16	4,518.00	4,889.82	4,617.98	4,274.31
Add: Deferred tax liabilities (M)	191.04	125.84	148.67	131.04	78.87
Capital Employed (N = K+L+M)	19,121.30	17,561.41	19,146.96	17,669.97	15,342.15
Profit for the year/ period (O)	743.48	181.42	1,898.72	2,139.37	1,353.98
Add: Tax expense (P)	250.40	64.81	661.19	704.22	460.36
Add: Finance costs (Q)	144.24	80.77	420.86	232.84	270.56
Earnings before interest and tax (R = O + P + Q)	1,138.12	327.00	2,980.77	3,076.43	2,084.90
Return on Capital Employed (S = R/N) (%)	5.95	1.86	15.57	17.41	13.59

*Not Annualised

Reconciliation of Capital Expenditure

(₹ in million, except as otherwise stated)

Particulars	Three months ended June 30,		As at/ for the Fiscal ended March 31,		
	2023	2022	2023	2022	2021
Addition to gross carrying value of property, plant and equipment (A)	177.70	306.34	850.83	413.13	474.89
Add: Adjustment pursuant to scheme of business acquisition in gross carrying value of property, plant and equipment (B)	-	266.04	266.04	-	-
Add: Addition to gross carrying value of capital work-in-progress (C)	162.50	177.37	718.65	601.61	315.54
Less: Deletion from gross carrying value of capital work-in-progress (D)	100.88	282.20	705.95	245.34	402.45
Add: Addition to gross carrying value of right of use assets (E)	74.58	321.98	637.64	73.78	70.25
Add: Addition to gross carrying value of other intangible assets (F)	-	0.00	0.27	1.93	-
Add: Adjustment pursuant to scheme of business acquisition in gross carrying value of other intangible assets (G)	-	69.59	69.59	-	-
Add: Addition to gross carrying value of intangible assets under development (H)	-	-	-	6.00	4.85
Less: Deletion from Gross carrying value of Intangible assets under development (I)	-	6.00	6.00	4.85	-
Capital Expenditure (J = A +B +C - D + E - F + G + H - I)	313.90	853.12	1,831.07	846.26	463.08

Reconciliation of Return on Equity

(₹ in million, except as otherwise stated)

Particulars	Three months ended June 30*,		As at/ for the Fiscal ended March 31,		
	2023	2022	2023	2022	2021
Profit for the year/period (A)	743.48	181.42	1,898.72	2,139.37	1,353.98
Closing equity** (B)	15,239.08	12,802.18	14,196.95	12,503.03	10,466.31
Opening equity** (C)	14,196.95	12,503.03	12,503.03	10,466.31	9,040.45
Average equity (D = (B + C)/2)	14,718.02	12,652.61	13,349.99	11,484.67	9,753.38
Return on Equity (E = A/D) (%)	5.05	1.43	14.22	18.63	13.88

*Not Annualised

**Equity means equity share capital plus Instrument entirely equity in nature plus other equity

Reconciliation of Debt to Equity Ratio

(₹ in million, unless otherwise specified)

Particulars	Three months ended June 30*,		As at/ for the Fiscal ended March 31,		
	2023	2022	2023	2022	2021
Non-current borrowings (A)	187.49	511.92	268.59	593.13	712.82
Add: Current borrowings (B)	3,850.16	4,518.00	4,889.82	4,617.98	4,274.31
Total Debt (C = A + B)	4,037.65	5,029.92	5,158.41	5,211.11	4,987.13
Equity share capital (D)	478.48	239.24	478.48	239.24	239.24
Instrument entirely equity in nature (E)	4,151.86	4,151.86	4,151.86	4,151.86	4,151.86
Other equity (F)	10,608.74	8,411.08	9,566.61	8,111.93	6,075.21
Equity (G = D + E + F)	15,239.08	12,802.18	14,196.95	12,503.03	10,466.31
Debt to Equity Ratio (H = C/G)	0.26	0.39	0.36	0.42	0.48

*Not Annualised

Reconciliation of Net Debt and Net Debt to EBITDA

(₹ in million, unless otherwise specified)

Particulars	Three months ended June 30*,		As at/ for the Fiscal ended March 31,		
	2023	2022	2023	2022	2021
Non-current Borrowings (A)	187.49	511.92	268.59	593.13	712.82
Add: Current Borrowings (B)	3,850.16	4,518.00	4,889.82	4,617.98	4,274.31
Less: Cash and cash equivalents (C)	151.41	67.07	310.35	123.00	83.96
Net debt (D = A + B - C)	3,886.24	4,962.85	4,848.06	5,088.11	4,903.17
EBITDA (E)	1,298.99	471.82	3,577.04	3,537.27	2,532.40
Net debt to EBITDA (F = D/E) (times)	2.99	10.52	1.36	1.44	1.94

*Not Annualised

In accordance with the SEBI ICDR Regulations, the audited standalone financial statements of our Company as identified in accordance with the SEBI ICDR Regulations, for the Fiscals ended 2023, 2022 and 2021 (“**Audited Financial Statements**”) and the reports are available on our website at www.rkabel.com/audited-financial-statements/statements. Our Company is providing a link to this website solely to comply with the requirements specified in the SEBI ICDR Regulations. Our Company does not have any subsidiary, as on the date of this Red Herring Prospectus.

The Audited Financial Statements do not constitute, (i) a part of this Red Herring Prospectus; or (ii) a prospectus, a statement in lieu of a prospectus, an offering circular, an offering memorandum, an advertisement, an offer or a solicitation of any offer or an offer document or recommendation or solicitation to purchase or sell any securities under the Companies Act, the SEBI ICDR Regulations, or any other applicable law in India or elsewhere. The Audited Financial Statements should not be considered as part of information that any investor should consider subscribing for or purchase any securities of our Company and should not be relied upon or used as a basis for any investment decision. None of our Company or any of its advisors, nor BRLMs or the Selling Shareholders, nor any of their respective employees, directors, affiliates, agents or representatives accept any liability whatsoever for any loss, direct or indirect, arising from reliance placed on any information presented or contained in the Audited Financial Statements, or the opinions expressed therein.

RELATED PARTY TRANSACTIONS

For details of the related party transactions, as per the requirements under applicable Accounting Standards, i.e., Ind AS 24 - Related Party Disclosures, read with the SEBI ICDR Regulations for the Fiscals ended 2023, 2022 and 2021 and three months period ended June 30, 2023 and June 30, 2022 and as reported in the Restated Consolidated Financial Information, see “*Restated Consolidated Financial Information – Annexure VI – Notes to Restated Consolidated Financial Information Note 33: Related party disclosures as required under Ind AS-24*” on page 330.

CAPITALISATION STATEMENT

The following table sets forth our Company's capitalisation as at June 30, 2023, on the basis of amounts derived from our Restated Consolidated Financial Information, and as adjusted for the Offer. This table should be read in conjunction with the sections titled "Risk Factors", "Financial Information", "Other Financial Information" and "Management's Discussion and Analysis of Financial Condition and Results of Operations", beginning on pages 28, 269, 372 and 379, respectively.

(₹ in million, unless otherwise stated)

Particulars	Pre-Offer as at June 30, 2023	Adjusted for the Offer*
Total borrowings		
Current borrowings [#] (A)	3,850.16	Refer notes below
Non-current borrowings (including current maturities of long-term borrowings) [#] (B)	187.49	
Total borrowings (C)	4,037.65	
Total equity		
Equity share capital	478.48	
Instrument entirely equity in nature	4,151.86	
Other equity [#]	10,608.74	
Total equity (D)	15,239.08	
Total non-current borrowings (including current maturities of long- term borrowings)/ Total equity (B)/(D)	0.01	
Total borrowings/ Total equity (C)/(D)	0.26	

Notes:

These terms carry the same meaning as per Schedule III of the Companies Act.

* The corresponding adjusted for the Offer capitalization data for each of the amounts given in the above table is not determinable at this stage pending the completion of the Book Building process and hence the same have not been provided in the above statement.

FINANCIAL INDEBTEDNESS

Our Company has availed credit facilities in the ordinary course of their business for the purposes of meeting working capital requirements and capital expenditure requirements. Our Board is empowered to borrow monies, in accordance with Section 179, Section 180 of the Companies Act and our Articles of Association. Pursuant to its resolution dated February 26, 2022, our Board has delegated its power to borrow money to the finance committee of our Company.

For further details regarding the borrowing powers of our Board, see “*Our Management – Borrowing Powers of Board*” on page 249.

The following table sets forth details of the aggregate outstanding borrowings of our Company, as on August 28, 2023.

Category of borrowing	Sanctioned Amount as on August 28, 2023 (in ₹ million)	Outstanding amount as on August 28, 2023 (in ₹ million)*
Secured Loans		
Fund Based		
Term loans	1,600.00	511.92
Working capital loan	4,200.00	3,220.68
Vehicle loan	-	-
Non Fund Based		
Letter of credit (backed by fixed deposit)	21.00	20.73
Letter of credit	450.00	484.56
Bank guarantee	-	211.37
Sub-total (A)	6,271.00	4,449.26
Unsecured Loans		
Fund Based		
Term loans	-	-
Working capital loan	3,185.00	738.10
Overdraft	-	-
Non Fund Based		
Letter of credit	650.00	2,603.62
Bank guarantee	-	5.75
Sub-total (B)	3,835.00	3,347.47
Total (A) + (B)	10,106.00	7,796.74

* As certified by Independent Chartered Accountant, by way of their certificate dated September 6, 2023.

For disclosure of borrowings as at June 30, 2023, as per requirements of Schedule III of Companies Act, 2013 and related accounting standards, see “*Financial Information*” beginning on page 269.

Principal terms of the borrowings availed by our Company:

Brief details of the terms of our various borrowing arrangements are provided below. The details provided below are indicative and there may be additional terms, conditions and requirements under the various borrowing arrangements entered into by our Company. For details, see “*Risk Factors – Internal Risk Factors- Our financing agreements contain covenants that limit our flexibility in operating our business. If we are not in compliance with certain of these covenants and are unable to obtain waivers from the respective lenders, our lenders may accelerate the repayment schedules, and enforce their respective security interests, leading to a material adverse effect on our business and financial condition.*” on page 54.

1. **Interest:** Interest rate charged by the lenders for our term loans is 8.95% and working capital loans typically ranges from 6.05% per annum to 8.85% per annum, whereas the commission on the non-fund based facilities range from 0.30% per annum to 2.10% per annum. The interest rates are primarily linked to the various benchmarks such as the marginal cost lending rate or treasury bills rate or repo rate.
2. **Tenor:** The tenor of our Company’s working capital facilities and channel finance facilities are maximum up to one year and can be renewed by mutual agreement, whereas the tenor of term loans is five years with moratorium generally of one year from the day of first disbursement under the facility. The working capital facilities are repayable on demand.
3. **Security:** Certain working capital facilities availed by us are typically unsecured. In terms of our borrowings where security needs to be created, we are typically required to create security by way of:
 - (a) hypothecation over all existing and future current assets and fixed immovable assets of the Company;
 - (b) first charge by equitable mortgage in favour of term lenders on immovable properties;
 - (c) second pari passu charge over land and building of Waghodia and Nawa Ajwa unit; and
 - (d) personal guarantees by the Promoters.

4. **Repayment:** The credit facilities are typically repayable on demand in accordance with the facility agreements executed by our Company. Each sub-limit has a specific schedule prescribed with provisions of periodic repayments for some of the sub-limits.

5. **Key covenants:**

In terms of our facility agreements and sanction letters, we are required to undertake certain actions and seek written prior consent of the lenders for certain actions:

- (a) take prior written consent of the bank to enter into any scheme of merger, amalgamation, or undertake buyback;
- (b) take prior written consent of the bank to make any amendments in the Company's constitutional documents;
- (c) take prior written consent of the bank to make any change in Company's capital structure/shareholding pattern or making any change in the Company's ownership/control or management.
- (d) take prior written consent of the bank to dispose its assets other than those as permitted by the bank in writing; and
- (e) take prior written consent of the bank to wind-up, liquidate or dissolve its affairs or take steps for its voluntary winding up or liquidation or dissolution.

6. **Events of Default:**

In terms of the facility agreements and sanction letters, the following, among others, constitute as events of default:

- (a) our Company or any other person is in breach of any covenants, conditions or any other terms of the transaction documents of the credit facilities;
- (b) default has occurred in the payment of any amount of the credit facilities due and payable on the due dates, whether by acceleration or otherwise;
- (c) if the Company has voluntarily taken any action for its insolvency, winding up or dissolution;
- (d) the security for the facilities is in jeopardy or ceases to have effect;
- (e) if any of the transaction documents executed or furnished by or behalf of the Company becomes illegal, invalid, unenforceable or fails or ceases to be in effect or fails or ceases to provide the benefit of the liens, rights, powers, privileges or security interests created by transaction documents;
- (f) if any of the transaction documents is assigned or otherwise transferred, amended or terminated, repudiated or revoked, without the approval of the bank;
- (g) if loan is utilized for any purpose other than sanctioned purpose;
- (h) occurrence of cross default;
- (i) occurrence of material adverse change affecting the business or financial position of the Company;
- (j) if any information, representation and warranty, statement made, or deemed to be made, in or in connection with any transaction document is incorrect or misleading in any material respect.

7. **Consequences of occurrence of events of default:**

In terms of the facility agreements and sanction letters, in case of occurrence of events of default set out above, our lenders may, among others:

- (a) terminate the facilities and/ or declare that the dues and all obligations shall immediately become due and payable;
- (b) declare security created to be enforceable;
- (c) take possession of and/or transfer the assets comprised within the security; and
- (d) exercise such remedies as may be permitted or available to the Bank under law, including RBI guidelines.

Our Company has obtained written approvals from our lenders, to the extent required under the agreements and loan documents entered into between us and such lenders, for undertaking the Offer and activities in connection thereto and the same have not been withdrawn as on the date of this Red Herring Prospectus.

MANAGEMENT'S DISCUSSION AND ANALYSIS OF FINANCIAL CONDITION AND RESULTS OF OPERATIONS

You should read the following discussion in conjunction with our Restated Consolidated Financial Information as of and for Fiscals 2021, 2022 and 2023 and three months ended June 30, 2022 and June 30, 2023, including the related annexures.

Unless otherwise indicated or context otherwise requires, the financial information for Fiscals 2021, 2022 and 2023 and three months ended June 30, 2022 and June 30, 2023, included herein is derived from the Restated Consolidated Financial Information, included in this Red Herring Prospectus. For further information, see "Financial Information" on page 269.

Our Fiscal year ends on March 31 of each year. Accordingly, all references to a particular Fiscal are to the 12-month period ended March 31 of that year.

This discussion contains forward-looking statements that involve risks and uncertainties and reflects our current view with respect to future events and financial performance. Actual results may differ from those anticipated in these forward looking statements as a result of factors such as those set forth under "Forward Looking Statements" and "Risk Factors" on pages 27 and 28, respectively.

Overview

We are one of the leading companies in the Indian consumer electrical industry (comprising wires and cables and fast moving electrical goods ("FMEG")), with an operating history of over 20 years in India. The Indian consumer electrical industry was estimated at ₹1,811.50 billion in Fiscal 2023 and is expected to grow at a compounded annual growth rate ("CAGR") of 10% until Fiscal 2027 to reach a market value of approximately ₹2,665.00 billion. (Source: Technopak Report) We are one of the leading companies in the Indian consumer electrical industry on account of the following:

- We are the fastest growing consumer electrical company among our peers in India, growing at a CAGR of 43.4% between Fiscal 2021 and Fiscal 2023;
- We are the fifth largest player in the wires and cables market in India, representing approximately 5% market share by value as of March 31, 2023;
- We are the fifth largest player in branded wires and cables market in India, representing approximately 7% market share by value as of March 31, 2023 as compared to approximately 5% market share by value as of March 31, 2015;
- We had the highest revenue contribution from the business-to-consumer ("B2C") sales channel in wires and cables with approximately 74% of revenue coming from the B2C sales channel as of March 31, 2023;
- In calendar year 2022, we were one of the leading exporter of wires and cables from India, in terms of value, representing approximately 9% market share of the exports market from India;
- We have one of the largest network of electricians, covering 271,264 electricians across India, as of March 31, 2023;
- In Fiscal 2023, our revenue contribution from FMEG segment is approximately 11%, which is highest among our peers. This has continued to remain the highest at 11% among our peers even in the three months ended June 30, 2023. For further details in relation to peer comparison, see "Industry Overview – Competitive Landscape" on page 181;
- We have one of the highest number of distributors servicing the extensive retail footprint in consumer electrical industry as on March 31, 2023 and have increased our retailer outlets by 3 times from 30,570 in Fiscal 2021 to 106,626 in Fiscal 2023, pursuant to undertaking several initiatives; and
- Our products have 35 international product certifications, which is one of the highest in number among our peers in the Indian consumer electrical industry as of March 31, 2023.

(Source: Technopak Report)

We sell products across two broad segments - (i) wires and cables including house wires, industrial wires, power cables and special cables; and (ii) FMEG including fans, lighting, switches and appliances. In three months ended June 30, 2023, (i) 71% of our revenue from operations from our wires and cables segment (of which all of our revenue from operations from our house wires products); and (ii) 97% of our revenue from operations from our FMEG segment, are from the B2C channel. Our product's end use determines whether the sale is through a business-to-business ("B2B") or B2C channel. According to Technopak, B2C sales provide a higher gross margin as compared to B2B sales.

We undertake the manufacturing, marketing and sale of (i) our wires and cable products under our 'RR Kabel' brand, and (ii) a variety of consumer electrical products, including fans and lights under the 'RR' brand, which is licensed by us. We also manufacture, market and sell fans and lights under the 'Luminous Fans and Lights' brand, which is licensed by us. Our 'RR Kabel' brand has over 20 years of operating history, while the 'RR' and the 'Luminous Fans and Lights' brands, which are licensed by us, have over 7 years and over ten years of operating history, respectively. We have received several awards for our brand including Best Brand in Building Material and Fittings category at the ET Infra Focus Summit and Awards 2022; Marketing Campaign of the year 2018 award by ABP News Brand Excellence Award, and Power Brand India 2017 in "Industry

Trendsetter” category. We also won the won the Pride of India Brands Award, 2022. For further details, see “*History and Certain Corporate Matters – Awards, accreditations and recognitions received by our Company*” on page 238.

Our wires and cables segment has been in operation since Fiscal 1999 and includes a wide range of products such as house wires, industrial wires, power cables and special cables. For further details in relation to our products, see “*Our Business – Description of our Business and Operations – Our Products*” on page 204. We were the first company in India to introduce low smoke zero halogen (“**LS0H**”) insulation technology in our wires and cables products, and to introduce unilay core technology (heat resistant and flame retardant) products. (Source: *Technopak Report*) For further details on the LS0H technology, see “*Industry Overview – Wires and Cables Market in India – Trends Shaping the Domestic Wires and Cables Market – New Technological Interventions*” on page 159. Our wires and cables segment contributed to 88.56% and 89.09% of our revenue from operations in Fiscal 2023 and three months ended June 30, 2023, respectively.

We have actively diversified and expanded our product portfolio in adjacent areas such as FMEG, both organically and inorganically. In Fiscal 2020, we amalgamated the business from one of our group companies, Ram Ratna Electricals Limited (“**RREL**”). In Fiscal 2020, we also acquired the light emitting diode (“**LED**”) lights and related hardware business (“**LED Lights Business**”) of Arraystorm Lighting Private Limited (“**Arraystorm**”), along with its trademarks and design certificates, to expand our portfolio to cover office, industrial and warehouse spaces. In May 2022, we acquired the corresponding home electrical business (“**HEB**”) of Luminous Power Technologies Private Limited (“**Luminous**”) and also obtained a limited and exclusive license to use the ‘Luminous Fans and Lights’ brand for fan and light products for an initial period of two years subject to extension of six months at a time for a maximum of four times and, that includes a right to use 61 registered trademarks, and a portfolio of lights and premium fans, to strengthen our FMEG portfolio. For further details, see “*History and Certain Corporate Matters – Details regarding material acquisitions or divestments of business/undertakings, mergers, amalgamation, any revaluation of assets, etc. in the last 10 years*” on page 238. We also started manufacturing switches in Fiscal 2021. We believe that this has enabled us to build a wide FMEG portfolio that benefits from our brand. According to Technopak, our FMEG portfolio covers approximately 77% of the FMEG industry by value in India as on March 31, 2023. Our FMEG segment contributed to 11.44% and 10.91% of our revenue from operations in Fiscal 2023 and three months ended June 30, 2023, respectively. For further details in relation to the synergies that we expect to realize from these acquisitions, see “*Our Business - Strengths – Well-positioned for growth in FMEG segment*” on page 199.

Our global distribution footprint encompasses both domestic sales within India and export sales across the world:

- **Domestic:** We have an extensive pan-India distribution presence and as on June 30, 2023, we have 3,450 distributors, 3,656 dealers and 114,851 retailers, on a non-exclusive basis. As part of our distribution strategy, we strive to provide our end-users a seamless experience through several touchpoints. Distributors purchase products from us and on-sell our products to end-users through retailers. Dealers purchase products from us and either, directly or through retailers, on-sell to end-users. The dealers, distributors and retailers, directly and indirectly, cover electricians. In addition, we have a focused approach to expand our geographical market share in India by identifying micro and nano markets. Micro markets are individual pin codes in urban towns (which are towns with a population of more than 0.3 million) and nano markets are particular localities within such pin codes. (Source: *Technopak Report*) As on June 30, 2023, we have 789 employees in our sales and marketing team, who manage and coordinate with distributors, dealers and retailers. We also have a presence on recognized e-commerce platforms. As on June 30, 2023, we have 21 warehouses across 17 states and union territories in India. We intend to consolidate our warehouses over time.
- **Exports:** We export our range of wires and cable products directly as well as through distributors across the world. During Fiscals 2021 to 2023 and three months ended June 30, 2023, we sold our products to 63 countries in North America, APAC, Europe and Middle East. For the three months period ended June 30, 2023, 99% of our export revenue was derived from distributors, and 1% was derived from original equipment manufacturers (“**OEMs**”). We export majority of our products under our brand ‘RR Kabel’ and manufacture under private labels for select customers. We have long-standing relationships with 10 distributors in these markets who cover the majority of our exports. Revenue from outside India grew at a CAGR of 47.13% between Fiscals 2021 and 2023, and it contributes 26.94% of our revenue from operations for the three months period ended June 30, 2023.

We have a strong focus on innovation and research and development and have relied on innovation to differentiate our wires and cables and FMEG products. We were the first company in India to launch products compliant with the European regulations, such as Registration, Evaluation, Authorization and Restriction of Chemicals (“**REACH**”); Restriction of Hazardous Substances Directive (“**ROHS**”) and Construction Products Regulations (“**CPR**”). (Source: *Technopak Report*) As on June 30, 2023, we have a dedicated team of 60 employees focused on research and development, of which 22 employees exclusively work on research and development involving FMEG products. Further, we have a strong focus on quality, and our central quality and test laboratory for wires and cables in our facility at Waghodia, Gujarat (“**Waghodia Facility**”) is accredited by the National Accreditation Board for Testing and Calibration Laboratories (“**NABL**”) and as of June 30, 2023 is capable of performing 694 tests on our products. In addition, we have quality control departments at our remaining facilities for process monitoring, raw material testing and type testing of products. We also have a dedicated quality control department for quality testing of switches at our Waghodia Facility. Certain products manufactured at our Waghodia Facility have over 30 global accreditations and registrations, including from British Approvals Service for Cables (“**BASEC**”), Underwriters Laboratories (“**UL**”), Canadian Standards Association (“**CSA**”), Verband der Elektrotechnik (“**VDE**”), Intertek, Technischer Überwachungsverein (“**TUV**”) Rheinland and Bureau of Indian Standards (“**BIS**”). (Source: *Technopak Report*)

We own and operate two integrated manufacturing facilities which are located at Waghodia, Gujarat, being the Waghodia Facility, and Silvassa, Dadra and Nagar Haveli and Daman and Diu (“**Silvassa Facility**”) in India, which primarily carry out manufacturing operations in respect of wire and cables and switches. Additionally, we own and operate three integrated manufacturing facilities which are located at Roorkee, Uttarakhand (“**Roorkee Facility**”), Bengaluru, Karnataka (“**Bengaluru Facility**”) and Gagret, Himachal Pradesh (“**Gagret Facility**”) in India, which carry out manufacturing operations in respect of FMEG products. Our Waghodia Facility is one of the largest consumer electrical manufacturing facilities in India as of March 31, 2023, with an annual manufacturing capacity of 2.1 million CKM of wires and cables. (*Source: Technopak Report*) Our manufacturing facilities give us the in-house ability to manufacture 100% of our requirements for wires and cables and approximately 37% of our requirements for FMEG products by value. We purchase our balance requirements for FMEG products from third parties and eventually sell them as traded goods. For further details in relation to our manufacturing facilities and contract manufacturing, see “*Our Business - Description of our Business and Operations – Manufacturing Facilities*” and “*Our Business – Description of our Business and Operations – Manufacturing Process*” on pages 209 and 211, respectively.

Our efforts towards environmental, social and corporate governance compliance include promoting green energy, community development and conserving water. Our Waghodia and Silvassa Facilities have an installed rooftop capacity of 1.2 MW and 0.25 MW, respectively, for solar energy. Further, our Waghodia Facility has an offsite hybrid solar and wind plant with an installed capacity of 3.82 MW. These constitute 59% and 5% of the contracted demand for electricity for our Waghodia and Silvassa Facilities, respectively, as of June 30, 2023. For further details, see “*Our Business - Description of our Business and Operations – Environmental, health and safety and sustainability initiatives*” on page 225.

Over the years, we have received several leading awards and recognitions such as the All India Kaizen Competition 2021-2022 award in productivity.

The following table provides a snapshot of certain of our financial and operational performance indicators for the periods indicated:

Particulars	As at / for the Fiscal ended March 31,			Three months ended June 30,	
	2021	2022	2023	2022	2023
Revenue from operations (in ₹ million)	27,239.41	43,859.36	55,992.00	12,359.10	15,973.14
Profit for the year / period (in ₹ million)	1,353.98	2,139.37	1,898.72	181.42	743.48
Segment profit / (loss) before tax and interest (wires and cables) (in ₹ million)	2,268.87	3,227.22	3,515.83	461.88	1,246.44
Segment profit / (loss) before tax and interest (FMEG) (in ₹ million)	(300.64)	(298.41)	(695.30)	(148.78)	(169.53)
Revenue from operations growth (%)	-*	61.01%	27.66%	-*	29.24%
Profit after tax growth (%) ¹	-*	58.01%	(11.25%)	-*	309.81%
PAT Margin (%) ^{2#}	4.93%	4.83%	3.37%	1.46%	4.61%
EBITDA (in ₹ million) ^{3#}	2,532.40	3,537.27	3,577.04	471.82	1,298.99
EBITDA Margin (%) ^{4#}	9.22%	7.98%	6.35%	3.79%	8.05%
EBITDA Growth (%) ⁵	-*	39.68%	1.12%	-*	175.31%
Return on Capital Employed (%) ^{5#}	13.59%	17.41%	15.57%	1.86%	5.95%
Return on Equity (%) ^{6#}	13.88%	18.63%	14.22%	1.43%	5.05%
Debt to Equity Ratio (times) ^{7#}	0.48	0.42	0.36	0.39	0.26
Fixed Asset Turnover ratio (times) ⁸	7.01	11.12	12.37	2.86	3.10
Wires and cables volume (MT)	37,139.00	45,629.00	54,571.00	11,380	15,559
Wires and cables volume growth (%)	-*	22.86%	19.60%	-*	36.72%

* Revenue from operations growth, wires and cables volume growth, EBITDA growth and profit after tax growth for Fiscal 2021 and three months ended June 30, 2023 has not been included as the comparative period has not been included in this Red Herring Prospectus.

1. Profit after tax is Profit for the period / year.
2. PAT Margin is calculated as Profit for the period / year divided by total income.
3. EBITDA is calculated as profit for the year/ period plus finance costs plus tax expense plus depreciation and amortization expense..
4. EBITDA Margin is calculated as EBITDA divided by total income.
5. Return on Capital Employed is calculated as Profit for the period/ year plus finance cost plus tax expenses (EBIT) divided by (Tangible Net Worth plus Total Debt plus Deferred Tax Liabilities). EBIT is not annualized. For reconciliation of Tangible Net Worth, see “Other Financial Information” on page 372.
6. Return on Equity is calculated as (Profit for the period/year less preference dividend) divided by average equity, profit for the period/year is not annualized.
7. Debt to Equity ratio is calculated as Total Debt divided by equity.
8. Fixed Asset Turnover ratio is calculated as Revenue from operations divided by average of (property, plant and equipment plus right of use assets).

**Average means (opening plus closing) divided by two.

***Growth is calculated as current period / year minus previous period / year divided by previous period/year.

****Total Debt is non-current borrowings plus current borrowings.

EBITDA, EBITDA Margin, EBITDA Growth, PAT Margin, Return on Capital Employed, Return on Equity and Debt to Equity Ratio are non-GAAP measures.

For reconciliation of non-GAAP measures, see “*Other Financial Information – Reconciliation of Non-GAAP Measures*” on page 372.

Our Promoters have extensive experience in the consumer electrical industry. TPG Asia VII SF Pte. Ltd. is our significant investor since Fiscal 2019. Our Promoter, Shreegopal Rameshwarlal Kabra won the Pride of India Honour at the Society Achievers Awards 2017 and 2022, and was the president of the Indian Electrical and Electronics Manufacturers' Association. Further, our Promoter, Kirtidevi Shreegopal Kabra was awarded the Savvy Women Empowerment Award in 2018. We also have a professional and experienced management team, consisting of our Key Managerial Personnel and Senior Management Personnel with experience in the consumer electrical business.

Significant Factors Affecting our Financial Condition and Results of Operations

Cost and availability of raw materials

Our cost of materials consumed constitutes a significant component of our cost structure. For Fiscals 2021, 2022 and 2023 and three months ended June 30, 2022 and June 30, 2023, our cost of materials consumed was ₹21,731.99 million, ₹35,755.15 million, ₹43,697.88 million, ₹10,401.30 million and ₹11,971.13 million, constituting 79.78%, 81.52%, 78.04%, 84.16% and 74.95% of our revenue from operations, respectively.

Our cost of materials consumed are generally impacted by our manufacturing volumes, mix of products, the prices paid for raw materials and manufacturing efficiency. Our primary raw materials required for the manufacture of our products include, copper, aluminum, PVC compound, LSOH compound, XLPE compound and solar cable compound. While we manufacture up to 99.71%, 24.33%, 50.59% and 0.37% of our requirements for PVC compound, LSOH compound, XLPE compound and solar cable compound, respectively, at our facilities for the three months ended June 30, 2023, we purchase our remaining requirements from third parties on a spot basis. The price of our other raw materials such as copper and aluminum are linked to the prices on the London Metal Exchange (“LME”), which are generally quoted in US Dollars. Accordingly, the price we pay for these raw materials can fluctuate due to volatility in the commodity markets and in exchange rates.

The following table sets forth the LME cash settlement prices of copper and aluminum based on monthly averages, for the periods indicated:

Raw Material	Fiscal 2021	Fiscal 2022	Fiscal 2023	June 30, 2022	June 30, 2023
	(USD per ton)				
Aluminum	1,802.51	2,769.39	2,490.39	2,881.95	2,263.22
Copper	6,878.71	9,691.33	8,548.71	9,526.36	8,478.17

While we are generally able to pass on changes in the cost of our raw materials to our customers (whether due to changes in commodity index prices or exchange rates), we may not be able to do so immediately or fully, and as a result, fluctuations in the price of these raw materials may affect our operating results. For instance, we acquired copper at high prices in March 2022 and April 2022, which was consumed between May and July 2022. However, there was a sharp decline in the commodity prices from USD 10,238 per ton in March 2022 to USD 7,530 per ton in July 2022. (Source: Technopak Report) As a result, we were able to pass on the change in copper prices to our customers only in a phased manner. The sharp decline in commodity prices resulted in a reduction in our sales price at a faster rate as compared to our cost price.

We do not have a commodity hedging policy. However, to manage such risks, we have agreements with several suppliers, primarily for copper and aluminum, pursuant to which we have a 30 to 45 days window to price our products from the date of delivery of raw material. We believe this enables us to manage cost volatility and have flexibility in pricing our products. For other suppliers with whom we do not have such pricing windows, as a general policy, we aim to purchase these commodities at prevailing market prices and sell the products at prices adjusted for the prevailing market prices. We typically sell our products with a simultaneous purchase of commodities on a back-to-back basis, to help minimize the price risk. For our OEM customers, real estate developers and institutional customers, for which we tend to have supply contracts for a longer duration, we generally include price variation clauses so that the sales price of our products gets adjusted periodically based on a formula that takes into account changes in raw material prices.

Fluctuations in exchange rates

We present our financial statements in Indian Rupees. However, given that we export our products to 63 countries as on June 30, 2023, a portion of our business transactions is denominated in foreign currencies. Our revenue from outside India geographical segment, as per Ind AS 108, constituted 21.54%, 22.97%, 22.69%, 27.80% and 26.94% of our revenue from operations in Fiscals 2021, 2022 and 2023 and three months ended June 30, 2022 and June 30, 2023, respectively. The exchange rates between the Indian Rupee and the US Dollar, Euro and British Pound have fluctuated in the past and our results of operations have been impacted by such fluctuations and may be impacted by such fluctuations in the future. For further details in relation to RBI reference exchange rates for USD, Euro and British Pound, see “*Certain Conventions, Presentation of Financial, Industry and Market Data*” on page 24. Further, our raw materials such as aluminium and copper are priced by reference to benchmarks quoted in US dollars, and hence, a significant component of our expenditures is largely influenced by the value of the US dollar.

Depreciation of the Indian Rupee against the U.S. Dollar, the Euro, British Pound and other foreign currencies may adversely affect our results of operations by increasing the cost of our raw materials or any proposed capital expenditure in foreign currencies. Similarly, appreciation of the Indian Rupee may positively affect our results of operations by decreasing the cost of

our raw materials or any proposed capital expenditure in foreign currencies. Although we generally seek to pass exchange rate fluctuations through to our customers through increases or decreases in our prices, we may not be able to do so immediately or fully, and hence significant volatility in the exchange rates can impact our revenue and profit. For further details, see “- Significant Factors Affecting our Financial Condition and Results of Operations – Cost and availability of raw materials” on page 382.

We have a risk management policy covering our foreign exchange risk, which is reviewed periodically by our management. We usually enter into foreign exchange forward contracts to mitigate our foreign exchange risk. However, any amounts we spend in order to hedge the risks on account of fluctuations in currencies may not adequately hedge against any losses we incur due to such fluctuations. We do not enter into financial instrument transactions for trading or speculative purposes. The following table sets forth our foreign currency exposure that is not hedged by derivative instruments or otherwise as at indicated dates:

	As at March 31, 2021	As at March 31, 2022	As at March 31, 2023	As at June 30, 2022	As at June 30, 2023
USD	5.03	(0.26)	2.91	(4.14)	4.30
Euro	0.07	0.21	(0.37)	(0.24)	(0.31)
GBP	0.06	0.15	0.01	0.28	0.01

Note: The foreign currency exposure is calculated as export trade receivables less import creditors less buyers' credit.

Working capital requirements and access to capital resources

We require a significant amount of working capital primarily for our raw material purchases and manufacturing our products before we receive payments from our customers. Our working capital requirements tend to increase if contractual or sales terms do not include advance payments or if under such contractual arrangements, payment is stipulated at the time of delivery of the final product to our customer. Our working capital requirements will increase in the event we undertake a larger number of orders as we grow our business. As on June 30, 2023, we fund our working capital requirements from current borrowings from banks and internal accruals.

We seek to improve our working capital management, namely to optimize our trade receivables, rationalize our inventory levels and improve credit terms for trade payables.

To optimize our trade receivables, we also use channel financing, whereby our customers enter into arrangements with banks through which we receive payment directly from banks, who in turn take on the customer's credit risk and seek to collect from customers. Channel financing reduces our risk of non-payment, and increases the speed at which we receive payment as we receive such payment directly from banks. For further details, see “Risk Factors – We have utilized channel financing from banks to our customers to facilitate our cash flows and provided guarantees for a portion of the amount owed by our customers to these banks. Any failure of our customers to repay the amounts under these channel financing arrangements may result in us incurring losses and may negatively impact our profitability.” on page 39. We also have a cash discount policy that is valid until March 31, 2024, pursuant to which we offer a cash discount ranging from 0.50% to 2.95% depending on the time period within which we receive payment from our customers.

Regarding our inventory, we usually keep 20-25 days of inventory of raw materials and work-in-progress goods at our facilities to enable us to withstand disruptions in supply as well as volatility in the price of raw material. To this end, we plan our inventory levels based on historical levels of sales, actual sale orders on hand and the anticipated production requirements taking into consideration any expected fluctuation in raw material prices and delivery delay. In recent years, we have increasingly focused on rationalizing our inventory management, to meet our future requirements against while not carrying undue levels of inventory.

To improve credit terms for trade payables, we have focused on negotiating better payment terms by using various credit lines.

The following table sets forth certain of our working capital ratios for the periods indicated:

	Fiscal			Three months ended	
	2021	2022	2023	June 30, 2022	June 30, 2023
Trade receivable days ¹	56	39	36	39	35
Inventory days ²	77	63	63	69	60
Trade payable days ³	25	14	24	24	31

¹ Trade receivable days is defined as average trade receivables divided by revenue from operations multiplied by 365 for fiscal years and 91 days for three months period

² Inventory days is defined as average inventory divided by Cost of Goods Sold multiplied by 365 for fiscal years and 91 days for three months period. Cost of Goods Sold have been defined as cost of materials consumed plus purchase of stock-in-trade plus changes in inventories of finished goods, stock-in-trade, work-in-progress and scrap.

³ Trade payable days is defined as average trade payables divided by Cost of Goods Sold multiplied by 365 for fiscal years and 91 days for three months period. Cost of Goods Sold have been defined as cost of materials consumed plus purchase of stock-in-trade plus changes in inventories of finished goods, stock-in-trade, work-in-progress and scrap.

*Average means (opening plus closing) divided by two.

While generally the time taken to convert our account receivables plus inventory minus accounts payable (“**Working Capital Cycle**”) has been declining over time despite commodity price volatility due to rationalization of our inventory levels, several other factors may adversely impact our Working Capital Cycle. For instance, in Fiscal 2021, our Working Capital Cycle was adversely impacted due to an increase in inventory and an adverse impact on sale of products in March 2021 due to COVID-19. In Fiscals 2021, 2022 and 2023 and three months ended June 30, 2022 and June 30, 2023, our Working Capital Cycle was 108 days, 88 days, 75 days, 84 days and 64 days, respectively.

Access to cost-effective funding

Our ability to grow depends largely on cost effective avenues of funding. Currently, our sources of funding include cash generated by operations, supplemented by external financing such as working capital loans, term loans, letters of credit and packing credit. Our aggregate borrowings (including current borrowings and non-current borrowings) for Fiscals 2021, 2022 and 2023 and three months ended June 30, 2022 and June 30, 2023 was ₹4,987.13 million, ₹5,211.11 million, ₹5,158.41 million, ₹5,029.92 million and ₹4,037.65 million, respectively. Our debt service costs as well as our overall cost of funding depends on many external factors, including developments in the Indian and global credit market, and in particular, interest rate movements and the existence of adequate liquidity in the debt markets. We believe that going forward the availability of sources of cost effective funding will be crucial for the growth of our operations. We have strong credit metrics as our Net Debt to EBITDA ratio was 1.94, 1.44, 1.36, 10.52 and 2.99 in Fiscals 2021, 2022 and 2023 and three months ended June 30, 2022 and June 30, 2023, respectively. Net debt is calculated as current borrowings plus non-current borrowings minus bank balances and cash and cash equivalents. Net debt to EBITDA ratio is a Non-GAAP Measure and for reconciliation see “*Other Financial Information – Non-GAAP Financial Measures*” on page 372.

Our borrowings increased by 4.49% to ₹ 5,211.11 million in Fiscal 2022 from ₹ 4,987.13 million in Fiscal 2021, primarily due to an increase in our working capital loan including interest accrued to ₹ 4,236.07 million in Fiscal 2022 from ₹ 3,958.63 million in Fiscal 2021 and an increase in current maturities of long term borrowings to ₹381.91 million in Fiscal 2022 from ₹ 315.68 million in Fiscal 2021. The increase in working capital loans was primarily attributable to an increase in our working capital requirements due to an increase in sale of finished goods and traded goods. For further details in relation to increase in sale of our products, see “*Fiscal 2022 compared to Fiscal 2021 – Total income – Revenue from operations*” on page 394. The increase in current maturities of long term borrowings was primarily due to an increase in disbursement in existing long term borrowings in Fiscal 2022. This was partially offset by a decrease in our long-term loans to ₹ 593.13 million in Fiscal 2022 from ₹ 712.82 million in Fiscal 2021. This was primarily attributable to a decrease in term loans. For further details, see “*Restated Consolidated Financial Information – Annexure VI – Notes to Restated Consolidated Financial Information Note 13A: Borrowings*” and “*Restated Consolidated Financial Information – Annexure VI – Notes to Restated Consolidated Financial Information Note 13B: Borrowings*” on pages 311 and 312, respectively.

Our borrowings decreased by 1.01% to ₹ 5,158.41 million as of March 31, 2023 from ₹ 5,211.11 million as of March 31, 2022, primarily due to a decrease in our long-term loans to ₹ 268.59 million as of March 31, 2023 from ₹ 593.13 million as of March 31, 2022 and a decrease in current maturities of long term borrowings to ₹ 324.43 million as of March 31, 2023 from ₹381.91 million as of March 31, 2022. The decrease in long-term loans and in current maturities of long term borrowings was primarily due to repayment of term loans. This was partially offset by an increase in our working capital loan including interest accrued to ₹ 4,565.39 million as of March 31, 2023 from ₹ 4,236.07 million as of March 31, 2022. This was primarily attributable to an increase in our working capital requirements as a result of an increase in operations. For further details, see “*Restated Consolidated Financial Information – Annexure VI – Notes to Restated Consolidated Financial Information Note 13A: Borrowings*” and “*Restated Consolidated Financial Information – Annexure VI – Notes to Restated Consolidated Financial Information Note 13B: Borrowings*” on pages 311 and 312, respectively.

Sales mix and margins

We produce a wide range of wires and cables products and FMEG products. In general, for our wires and cables segment, a higher percentage of sales of housing wires and special cables, tends to have a positive impact on our revenues as such products have higher prices and profit margins than other products. Housing wires and special cables typically have a stronger brand recognition as compared to other types of wires such as industrial cables and power cables thereby enabling us to sell these products at a higher price. Similarly, for our FMEG segment, products such as smart fans, professional lighting, energy conscious appliances and more efficient technologies have higher prices and profit margins as compared to our other FMEG products. In recent years, we have focused on improving our FMEG sales mix through a variety of means, including increasing brand awareness, enhancing the strength of our distribution network, and offering higher degrees of customization and more technologically advanced products.

Our Gross Margins differ across our segments. Our Gross Margin is calculated as gross segmental profit (i.e. segment revenue from operations less segment Cost of Goods Sold) divided by segment revenue from operations. For example, our wires and cables segment is relatively well established and enjoys a strong distribution network and economies of scale (see “*Our Business— Strengths - Scaled B2C business in the large and growing wires and cables industry*” on page 194), whereas our FMEG segment is newer and smaller than our wires and cables segment, and accordingly does not enjoy the same economies of scale. As a result, our wires and cables segment tends to have better Gross Margins than our FMEG segment, although this may change over time if we are able to further scale our FMEG segment.

Our PAT Margin, being profit for the year / period divided by total income, in Fiscals 2021, 2022 and 2023 and three months ended June 30, 2022 and June 30, 2023 was 4.93%, 4.83%, 3.37%, 1.46% and 4.61%, respectively. Our PAT margin declined during Fiscal 2023 due to the acquisition of the license for use of the ‘Luminous Fans and Lights’ brand for fan and light products and the corresponding home electrical business (“**HEB**”). However, our PAT Margin increased from three months ended June 30, 2022 to three months ended June 30, 2023 as a result of our acquisition and integration of the HEB of ‘Luminous Fans and Lights’ brand, coupled with the stabilization of commodity prices.

Our EBITDA Margin in Fiscals 2021, 2022 and 2023 and three months ended June 30, 2022 and June 30, 2023 was 9.22%, 7.98%, 6.35%, 3.79% and 8.05%, respectively. Our segment margin for wires and cables in Fiscals 2021, 2022 and 2023 and three months ended June 30, 2022 and June 30, 2023, was 9.00%, 7.85%, 7.09%, 4.18% and 8.76%, respectively. Our segment margins for FMEG were negatively impacted as we continued to scale up this segment by increasing our distribution channels and product offerings. Our segment margin for FMEG in Fiscals 2021, 2022 and 2023 and three months ended June 30, 2022 and June 30, 2023, was (14.76)%, (10.86)%, (10.85)%, (11.44) % and (9.73) %, respectively.

Manufacturing capacity and utilization

Our results of operations are directly affected by our sales volume, which in turn is a function of several factors, including our manufacturing capacity and market demand. We have five manufacturing facilities located in India. Our Waghodia Facility is one of the largest consumer electrical manufacturing facilities in India as of March 31, 2023, with an annual manufacturing capacity of 2.1 million CKM of wires and cables. (*Source: Technopak Report*) Our manufacturing facilities give us the in-house ability to manufacture 100% of our requirements for wires and cables and approximately 37% of our requirements for FMEG products by value. For further details in relation to our historic capacity and utilization, see “*Our Business- Description of our Business and Operations –Capacity and Capacity Utilization*” on page 210. The growth in our total income between Fiscals 2021 and 2023 corresponded with an increase in manufacturing volumes at our manufacturing facilities. We have also backward integrated our manufacturing process by producing several key raw materials, polyvinyl chloride (“**PVC**”) compound, LS0H compound, cross-linked polythene (“**XLPE**”) compound and solar cable compound in-house at our Waghodia and Silvassa Facilities. Our in-house raw material production capabilities are critical to our integrated manufacturing process as it enables us to ensure quality control, reduce raw material costs and logistics cost and reduce reliance on external suppliers.

We plan our production according to current customer demand to avoid over-production, high warehousing costs and write-offs, while maintaining a certain production volume to be cost-effective and efficient. We usually keep 20-25 days of inventory of raw materials and work-in-progress goods at our facilities. The ability to store raw materials and work in progress goods at our facilities enables us to withstand disruptions in supply as well as volatility in the price of raw material. We plan our inventory levels based on historical levels of sales, actual sale orders on hand and the anticipated production requirements taking into consideration any expected fluctuation in raw material prices and delivery delay. We store our finished products at the warehouses. Any changes in our manufacturing capacity, along with our rate of utilization of such capacity, will affect the volume of products we are able to sell which, in turn, affects our revenue from sales and has a significant impact on our results of operations.

Delays in the capacity adjustment process following a significant decrease in demand, or conversely a greater than expected increase of competitors’ investments in additional capacity, might lead to overcapacity and a reduction in our utilization. This in turn may cause reduced sales volumes and/or a decrease in prices, which would have a negative impact on our business, financial condition and results of operations. If we do not succeed in reducing our overcapacity at reasonable cost, thereby lowering our cost base and minimizing the excess supply that contributes to a potential decrease in prices, or if strategically we continue to operate manufacturing facilities because we expect a recovery in demand, we may face a further decline in cash flow. Even if we successfully reduce our capacity, such reduction may lead to significant cost, in particular if restructuring measures are required

Macro-economic conditions and factors affecting the industries in which our customers operate

We derive majority of our revenue from operations from the manufacture and supply of wires and cables and fast moving electrical goods (“**FMEG**”). We have a diverse customer base comprising distributors, dealers, retailers, electricians, large institutions, governmental authorities and original equipment manufacturers (“**OEMs**”). Our customers are from a range of industries including real estate (including commercial and residential construction), infrastructure, automobile, telecommunication, railways, textile, pharmaceutical, paint, cement and data centers. We depend on the demand from these customers and the industries in which they operate. In turn, these industries largely depend on general macro-economic conditions. Certain general macro-economic factors that can affect the above industries and, thereby, demand for our products, include:

- local and global economic or fiscal crises or instability;
- demographic conditions and population dynamics, such as the absolute size of a market and the growth rates of the population in that market;
- economic development and shifting of wealth in India, in particular, growth in the middle class and rural areas, as well as the agricultural sector, which is highly dependent on the outcome of the monsoon season;

- local and global fiscal and monetary dynamics, such as rise or fall in interest rates, foreign exchange rates and inflation rates;
- general levels of GDP growth in a country or region, and trends in personal disposable income and consumer spending in that country or region; and
- global and local political and regulatory measures and developments, such as government policies to support the industries in which our customers operate, tax incentives or other subsidies or bilateral trade agreements (for a description of governmental policies that affect our results of operations and financial condition, see “—*Government regulations and policies*” on page 386);

The cyclical nature of general macro-economic conditions and, therefore, of the industries in which our customers operate means that our results of operations can fluctuate substantially from period to period. Stronger macro-economic indicators, such as GDP growth, increases in infrastructure investment, housing demand or consumer spending, increase in disposable income trend, improvements in industrial production and rural electrification drive tend to correlate with increased activities in industries in which our customers operate. For instance, according to Technopak, residential sales volume across the major cities in India witnessed a 51% annual rise from approximately 350,000 unit sold in 2022 as compared to approximately 230,000 units sold in 2021, signifying a healthy recovery in the sector after the impact of the COVID-19 pandemic. We believe that this in turn would result in an increased demand for our products, while weaker macro-economic indicators tend to correlate with less activities in the above industries and therefore, lower demand for our products. We expect that these macro-economic factors and conditions in the above industries will continue to be the most important factor affecting our revenues and results of operations.

Further, in Fiscals 2021, 2022 and 2023 and three months ended June 30, 2022 and June 30, 2023, we derived 78.46%, 77.03%, 77.31%, 72.20% and 73.06% of our revenue from operations within India, respectively. India’s nominal GDP has grown at a CAGR of 11.7% between Fiscal 2010 and Fiscal 2021 and is expected to continue the trend by registering an expected CAGR of 11.9% between Fiscal 2021 and Fiscal 2024. (*Source: Technopak Report*).

See “*Industry Overview*” on page 139 of this Red Herring Prospectus, for a discussion on macro-economic conditions in the industry in which we operate.

Government regulations and policies

According to Technopak, there are certain key factors, supported by a positive macro-environment, that are expected to provide growth in the wires and cables and FMEG industry between Fiscals 2022 and 2032 such as government led initiatives in the infrastructure and real estate industry as well as rural electrification. For further details, see “*Industry Overview – Consumer Electrical Industry in India – Key Growth Drivers of Consumer Electrical Industry in India*” on page 147.

In particular, the Government of India has also announced policies aimed at boosting GDP and economic growth, which are intended to provide the impetus for the growth of the consumer electrical industry in India, including the National Infrastructure Pipeline and ‘Housing for All’ scheme (Pradhan Mantri Awas Yojana) (*Source: Technopak Report*).

According to Technopak, the Indian wires and cables industry is gradually moving from a largely unbranded segment comprising smaller regional players to a more branded segment comprising pan-India players. The share of branded players in domestic wires and cables and FMEG industry is approximately 76% in Fiscal 2023. (*Source: Technopak Report*) According to Technopak, this consolidation of branded players is driven both by demand and supply side factors, including rising awareness among consumers towards safety and quality, the GST regime and technological innovations.

We believe that these initiatives of the Government of India will drive the demand for wires and cables products and consumer electrical products, including for products that we manufacture. Further, increasing urbanization in India coupled with rising income levels have resulted in progressively increasing demand for housing, particularly quality housing, across Indian cities. We believe that this growing demand for quality housing will drive demand for quality electric accessories, including those we manufacture. Any failure in the effective implementation of such plans would significantly and adversely affect our business, financial condition and results of operations.

Seasonality

Our business is seasonal in nature. Typically, customers purchase FMEG products such as fans and water heaters due to seasonal factors. For example, fans sales increase leading up to the summer season and water heaters sales increase in the cooler winter months. For our wires and cables business, sales are slower in the first of the year as certain customers may not have finalized their annual business plans or budgets at the start of the year. These factors result in the second half of the fiscal year seeing higher sales volume compared to the first half of the fiscal year.

Operating costs, in contrast, do not generally experience significant seasonal fluctuations, and as a result, the financial results for interim periods may not be indicative of results for the entire fiscal year. We expect such seasonal trends to continue.

Competition

We operate in an increasingly competitive market. We face competition from other manufacturers, traders, suppliers and importers of wires and cable, and consumer electrical products in relation to our offerings. Suppliers in the consumer electrical industry compete based on key attributes including products, price, customer service, post-sales service, quality and delivery.

Further, many of our competitors may have competitive advantages, including greater brand recognition and greater access to financial, research and development, marketing, distribution and other resources and larger product offerings than us. Additionally, certain of our competitors may specialize in manufacturing wires and cable, and consumer electrical products within particular product verticals and hence, may be able to dedicate significantly larger resources towards developing and manufacturing technologically superior equipment than us and their brands may gain greater visibility within those product verticals. Our competitors may further, enter into business combinations or alliances that strengthen their competitive positions or prevent us from taking advantage by entering into such business combinations or alliances. Increasing competition may result in pricing pressures or decreasing profit margins or lost market share or failure to improve our market position, any of which could substantially harm our business and results of operations. We will be required to compete effectively with our existing and potential competitors, to maintain and grow our market share and in turn, our results of operations. Factors, such as the availability of our products, our competitiveness, manufacturing capabilities, technological advancement, brand recognition, the strength of our sales and distribution network, the quality and price of our goods and our after sale service have an effect on our market share and our ability to win customers in competitive situations.

For further details in relation to the competition we face and our significant competitors, see “*Industry Overview*” and “*Our Business - Competition*” on pages 139 and 227, respectively.

Critical accounting policies and significant judgments and estimates

The methods, assumptions, and estimates that we use in applying our accounting policies may require us to apply judgments regarding matters that are inherently uncertain. We consider an accounting policy to be a critical estimate if: (1) we must make assumptions that were uncertain when the judgment was made, and (2) changes in the estimate assumptions, or selection of a different estimate methodology, could have a significant impact on our financial position and the results that we report in our Restated Consolidated Financial Information. While we believe that our estimates, assumptions, and judgments are reasonable, they are based on information available when the estimate was made.

Refer to “*Restated Consolidated Financial Information - Annexure V- Material Accounting Policies to Restated Consolidated Financial Information*” on page 285 for further information on our accounting estimates. Further, our material accounting policies, are as follows:

- **Inventories:**
 - The raw materials, work-in-progress, stock-in-trade and finished goods are valued at the lower cost or net realizable value. The cost is determined using first in first out (“**FIFO**”) method.
 - The cost of inventories comprises the cost of purchase, the cost of conversion and the cost of packing materials in case of finished goods.
 - The cost of purchase comprises of the purchase price including duties and taxes (other than those subsequently recoverable by us from the taxing authorities), freight inward and other expenditure directly attributable to the acquisition but net of trade discount, rebates, duties for import under advance licenses and other similar items.
 - The cost of conversion comprises of depreciation on factory buildings and plant and machineries, power and fuel, factory management and administration expenses, repairs and maintenance and consumable stores and spares.
 - Packing materials, consumable stores and spares and fuel are valued at lower of cost or net realizable value. The cost is determined using FIFO method.
 - Scrap is valued at net realizable value.

- **Revenue**

Revenue from contracts with customers is recognized when control of the goods and services are transferred to our customer at an amount that reflects the consideration to which we expect to be entitled in exchange for those goods or services. We assess promises in the contract that are separate performance obligations to which a portion of transaction price is allocated.

Revenue is measured based on the transaction price as specified in the contract with our customer. It excludes taxes or other amounts collected from customers in its capacity as an agent. In determining the transaction price, we consider the following:

- Variable consideration: This includes trade discounts, rebates and returns. It is estimated at the contract inception and constrained until it is highly probable that a significant revenue reversal in the amount of cumulative revenue recognized will not occur when the associated uncertainty with the variable consideration is subsequently resolved. It is reassessed at end of each reporting period.
- Consideration payable to a customer: Such amounts are accounted as a reduction of transaction price and therefore, of revenue unless the payment to the customer is in exchange for a distinct good or service that the customer transfers to us.
- Trade receivable: A receivable represents our right to an amount of consideration that is unconditional i.e., only the passage of time is required before payment of consideration is due.

Segment reporting

We have identified the following segments: (i) wires and cables; and (ii) FMEG. FMEG includes fans, LED lighting, switches, switchgears, water heaters and domestic appliances. We generally account for the intersegment sales and transfers at cost plus appropriate margins. For certain customers, a common purchase order is raised for both wires and cables and FMEG segments. As a result, there are certain eliminations to account for respective segmental sales.

(₹ in million)

Segment revenue	For Fiscal			Three months ended June 30,	
	2021	2022	2023	2022	2023
Wires and cables	25,202.47	41,112.71	49,585.32	11,058.27	14,230.82
FMEG	2,038.86	2,749.63	6,474.85	1,301.59	1,850.87
Elimination	(1.92)	(2.98)	(68.17)	(0.76)	(108.55)
Total Revenue from operations	27,239.41	43,859.36	55,992.00	12,359.10	15,973.14

Information about revenue split by geographical area

Segment revenue by geographical location is as follows:

Revenue from operations by geography	For Fiscal						Three months ended June 30,			
	2021		2022		2023		2022		2023	
	(in ₹ million)	%	(in ₹ million)	%	(in ₹ million)	%	(in ₹ million)	%	(in ₹ million)	%
Within India	21,371.75	78.46%	33,783.82	77.03%	43,290.10	77.31%	8,922.80	72.20%	11,669.41	73.06%
Outside India	5,867.66	21.54%	10,075.54	22.97%	12,701.90	22.69%	3,436.30	27.80%	4,303.73	26.94%
Total Revenue from operations	27,239.41	100.00%	43,859.36	100.00%	55,992.00	100.00%	12,359.10	100.00%	15,973.14	100.00%

Key components of Revenue and Expenses

We report our income and expenditure in the following manner:

Total income

Our total income comprises our revenue from operations and other income.

Revenue from operations. Our revenue from operations primarily comprises (i) sale of products and (ii) other operating revenues. Other operating revenue includes sale of scrap, processing charges and export incentives. These processing charges pertain to income received for manufacturing products pursuant to job orders for certain customers.

Other income. Other income primarily comprises interest income from bank deposits, interest on delayed payments from customers, dividend income, fair value gain on investment on mutual fund, other non-operating income such as rent income, guarantee commission, grant related to property, plant and equipment, foreign exchange gain (net), gain on sale of property, plant and equipment, gain on sale of mutual fund investments, other income, bad debts recovered and reversal of expected credit loss provision on trade receivables (net). Pursuant to our channel financing program, we have arranged credit facilities for our customers from various banks and we have issued first loss default guarantee ("FLDC"). If the customer defaults on repayment of the loan extended by the banks, the same is recovered from us pursuant to the FLDC and subject to other terms of the channel financing program. The adjustment of the notional recognition of the FLDC as financial liability is treated as 'guarantee commission' as per Ind AS requirements.

Expenses

Cost of material consumed: Cost of material consumed primarily consists of cost of raw materials that we use in the manufacture of our products, including aluminum, copper, galvanized iron, packing material, LSOH compound, master batch, solar compound, PVC compound and XLPE compound.

Purchase of stock-in-trade: Purchase of traded goods primarily consists of products such as fans, LED lighting, switches, switchgears, water heaters and domestic appliances which we eventually sell as traded goods.

Changes in inventories of finished goods, stock-in-trade, work-in-progress and scrap: Changes in inventories of finished goods, stock-in-trade and work-in-progress is the difference between our inventories at the start of the year and the end of the year.

Employee benefits expense. Our employee benefits expense primarily comprises salaries, wages and incentive, remuneration to directors, employees share based payment expenses, contributions to provident fund and ESIC, contributions to gratuity fund, compensated absences and staff welfare expenses.

Finance costs. Our finance costs primarily comprise interest on borrowing, interest on lease liabilities, other borrowing costs, interest on income tax and exchange gain/loss on foreign exchange borrowings.

Depreciation and amortization expense. Depreciation and amortization expense include depreciation of property, plant and equipment, amortization of intangible assets and depreciation of right-of-use assets.

Other expenses. Our other expenses primarily comprise, among others, repair and maintenance of buildings, plant and machinery and others, commission on sales typically paid to dealers and distributors, advertisement and business promotion expenses, travelling expenses, legal and professional fees, insurance charges, allowance for expected credit loss on trade receivables (net), consumption of consumable stores and spares, corporate social responsibility expenses, freight and distribution charges, power and fuel, research and development expenses, warranty expenses, miscellaneous expenses. The miscellaneous expenses broadly include expenses such as computer software expenses, hotel and boarding expenses, security expenses, testing charges and conveyance expenses and office expenses.

Share of profit/ (loss) of joint venture (net of tax)

Our share of profit/(loss) of joint venture comprises our share of the results of the JV.

Tax expense

Our tax expense primarily comprises current tax, short provision of tax of earlier years and deferred tax. Current tax is the amount of tax payable on the taxable income for the year as determined in accordance with the applicable tax rates and provisions of the applicable tax laws. Deferred tax liability or credit is recognized based on the difference between taxable profit and book profit due to the effect of timing differences. We measure our deferred tax based on the applicable tax rates and tax laws that have been enacted or substantively enacted by the relevant balance sheet date.

Other comprehensive income

Other comprehensive income / (loss) comprises (A) (i) re-measurement of post-employment benefits obligations; and (ii) income tax effect on (i) above; (B)(i) Fair value gain on investment in equity instruments through OCI; (ii) income tax relating to items that will not be reclassified to profit and loss; and (C) exchange difference arising on translation of foreign operation.

Our results of operations

The following table sets forth select financial data from our restated consolidated statement of profit and loss for three months ended June 30, 2023 and June 30, 2022 and Fiscals 2023, 2022 and 2021 and we have expressed the components of select financial data as a percentage of total income for such periods / years:

	Three months ended June 30,				Fiscals					
	2023		2022		2023		2022		2021	
	(₹ in million)	(% of total income)	(₹ in million)	(% of total income)	(₹ in million)	(% of total income)	(₹ in million)	(% of total income)	(₹ in million)	(% of total income)
Revenue from operations	15,973.14	98.99%	12,359.10	99.41%	55,992.00	99.39%	43,859.36	98.96%	27,239.41	99.20%
Sale of products	15,805.05	97.95%	12,194.94	98.09%	55,368.89	98.28%	43,193.02	97.45%	26,733.31	97.36%

	Three months ended June 30,				Fiscals					
	2023		2022		2023		2022		2021	
	(₹ in million)	(% of total income)	(₹ in million)	(% of total income)	(₹ in million)	(% of total income)	(₹ in million)	(% of total income)	(₹ in million)	(% of total income)
Other operating revenues	168.09	1.04%	164.16	1.32%	623.11	1.11%	666.34	1.50%	506.10	1.84%
Other income	162.84	1.01%	73.90	0.59%	344.40	0.61%	462.82	1.04%	219.95	0.80%
Total Income	16,135.98	100.00%	12,433.00	100.00%	56,336.40	100.00%	44,322.18	100.00%	27,459.36	100.00%
Expenses										
Cost of materials consumed	11,971.13	74.19%	10,401.30	83.66%	43,697.88	77.57%	35,755.15	80.67%	21,731.99	79.14%
Purchase of stock-in-trade	923.35	5.72%	964.38	7.76%	3,688.53	6.55%	1,566.17	3.53%	1,298.64	4.73%
Changes in inventories of finished goods, stock-in-trade, work-in-progress and scrap	160.83	1.00%	(940.95)	(7.57%)	(1,629.40)	(2.89%)	(1,241.50)	(2.80%)	(1,538.45)	(5.60%)
Employee benefits expense	767.69	4.76%	611.75	4.92%	2,641.59	4.69%	1,888.53	4.26%	1,483.45	5.40%
Finance costs	144.24	0.89%	80.77	0.65%	420.86	0.75%	232.84	0.53%	270.56	0.99%
Depreciation and amortization expense	160.87	1.00%	144.82	1.16%	596.27	1.06%	460.84	1.04%	447.50	1.63%
Other expenses	1,020.65	6.33%	922.87	7.42%	4,370.20	7.76%	2,858.53	6.45%	1,962.31	7.15%
Total expenses	15,148.76	93.88%	12,184.94	98.00%	53,785.93	95.47%	41,520.56	93.68%	25,656.00	93.43%
Profit before share of joint venture and tax	987.22	6.12%	248.06	2.00%	2,550.47	4.53%	2,801.62	6.32%	1,803.36	6.57%
Share of profit/(loss) of joint venture (net of tax)	6.66	0.04%	(1.83)	(0.01%)	9.44	0.02%	41.97	0.09%	10.98	0.04%
Profit before tax	993.88	6.16%	246.23	1.98%	2,559.91	4.54%	2,843.59	6.42%	1,814.34	6.61%
Tax expense										
Current tax	247.25	1.53%	64.15	0.52%	658.32	1.17%	648.27	1.46%	489.12	1.78%
Short / (excess) provision of tax of earlier years	-	-	-	-	3.87	0.01%	2.99	0.01%	(7.89)	(0.03%)
Deferred tax charge/(credit)	3.15	0.02%	0.66	0.01%	(1.00)	(0.00%)	52.96	0.12%	(20.87)	(0.08%)

	Three months ended June 30,				Fiscals					
	2023		2022		2023		2022		2021	
	(₹ in million)	(% of total income)	(₹ in million)	(% of total income)	(₹ in million)	(% of total income)	(₹ in million)	(% of total income)	(₹ in million)	(% of total income)
Profit for the year/period	743.48	4.61%	181.42	1.46%	1,898.72	3.37%	2,139.37	4.83%	1,353.98	4.93%
Total other comprehensive income/(loss), net of tax	295.47	1.83%	(52.29)	(0.42%)	122.81	0.22%	167.50	0.38%	71.88	0.26%
Total comprehensive income for the year/period	1,038.95	6.44%	129.13	1.04%	2,021.53	3.59%	2,306.87	5.20%	1,425.86	5.19%

Three months ended June 30, 2023 compared to three months ended June 30, 2022

Total income

Our total income increased by 29.78% to ₹16,135.98 million for three months ended June 30, 2023 from ₹12,433.00 million for three months ended June 30, 2022. This increase was due to an increase in revenue from operations and other income.

Revenue from operations. Our revenue from operations increased by 29.24% to ₹15,973.14 million for three months ended June 30, 2023 from ₹12,359.10 million for three months ended June 30, 2022, primarily due to an increase in sale of finished goods to ₹14,522.83 million for three months ended June 30, 2023 from ₹11,187.90 million for three months ended June 30, 2022. This was primarily attributable to:

- an increase in revenue from operations from wires and cables segment by 28.69% to ₹14,230.82 million for three months ended June 30, 2023 from ₹11,058.27 million for three months ended June 30, 2022, primarily due to an increase in volume of products sold by 36.72%; and
- an increase in revenue from operations from FMEG segment by 33.94% to ₹1,742.32 million for three months ended June 30, 2023 from ₹1,300.83 million for three months ended June 30, 2022, primarily on account of acquisition of the license for the 'Luminous Fans and Lights' brand for fan and light products and the corresponding HEB.

This was partially offset by an increase in rebate and discounts to ₹701.90 million for three months ended June 30, 2023 from ₹368.39 million for three months ended June 30, 2022.

Other income. Our other income increased by 120.35% to ₹162.84 million for three months ended June 30, 2023 from ₹73.90 million for three months ended June 30, 2023, primarily due to increase in foreign exchange gain (net) to ₹102.72 million for three months ended June 30, 2023 from ₹28.16 million for three months ended June 30, 2022. The increase in foreign exchange gain (net) is largely due to gains from mark to market on forward contracts due to foreign exchange fluctuations..

Expenses

Cost of materials consumed. Our cost of materials consumed increased by 15.09% to ₹11,971.13 million for three months ended June 30, 2023 from ₹10,401.30 million for three months ended June 30, 2022, primarily due to an increase in volume of raw material purchased on account of higher sales.

Purchase of stock-in-trade. Our purchases of stock-in-trade decreased by 4.25% to ₹923.35 million for three months ended June 30, 2023 from ₹964.38 million for three months ended June 30, 2022, relating primarily to increased purchases of FMEG products, such as lights, electric irons, room heaters and water heaters, including pursuant to our acquisition of HEB of 'Luminous Fans and Lights' brand.

Changes in inventories of finished goods, stock-in-trade, work-in-progress and scrap. Change in inventories of finished goods, stock-in-trade, work in progress and scrap was an increase of ₹160.83 million for three months ended June 30, 2023 as compared to a reduction of ₹940.95 million for three months ended June 30, 2022, primarily attributable to a higher closing inventory of finished goods and work in progress as of June 30, 2022 compared to March 31, 2022 while there was no significant variation between June 30, 2023 and March 31, 2023.

Employee benefits expense. Employee benefits expense increased by 25.49% to ₹767.69 million for three months ended June 30, 2023 from ₹611.75 million for three months ended June 30, 2022, primarily due to increase in salaries, wages and incentives

to ₹656.53 million for three months ended June 30, 2023 from ₹525.17 million for three months ended June 30, 2022. This is primarily attributable to an increase in number of employees from 2,983 as of June 30, 2022 to 3,108 as of June 30, 2023, including on account of our acquisition of HEB of 'Luminous Fans and Lights' brand, and annual compensation increments given to employees.

Finance costs. Finance costs increased by 78.58% to ₹144.24 million for three months ended June 30, 2023 from ₹80.77 million for three months ended June 30, 2022, primarily due to increase in interest on borrowings to ₹125.59 million for three months ended June 30, 2023 from ₹74.92 million for three months ended June 30, 2022. This was primarily attributable to an increase in the interest rate of borrowings and higher utilization of short term working capital loans due to higher working capital requirements as a result of an increase in operations.

Depreciation and amortization expense. Depreciation and amortization expense increased by 11.08% to ₹160.87 million for three months ended June 30, 2023 from ₹144.82 million for three months ended June 30, 2022, primarily due to increase in depreciation of property, plant and equipment to ₹120.84 million for three months ended June 30, 2023 from ₹105.95 million for three months ended June 30, 2022. This was primarily attributable to additions to our manufacturing facilities, plant machinery and right-of-use assets.

Other expenses. Our other expenses increased by 10.60% to ₹1,020.65 million for three months ended June 30, 2023 from ₹922.87 million for three months ended June 30, 2022, primarily due to:

- increase in advertising and business promotion expenses to ₹188.15 million for three months ended June 30, 2023 from ₹134.45 million for three months ended June 30, 2022 due to our focus on increasing our brand presence;
- increase in power and fuel charges to ₹141.91 million for three months ended June 30, 2023 from ₹109.05 million for three months ended June 30, 2022 due to an increase in manufacturing at our operations; and
- increase in miscellaneous expenses to ₹115.22 million for three months ended June 30, 2023 from ₹79.83 million for three months ended June 30, 2022.

This was partially offset by a decrease in our legal and professional fees to ₹27.82 million in June 30, 2023 from ₹48.51 million in June 30, 2022 and warranty costs to ₹40.18 million in June 30, 2023 from ₹59.96 million in June 30, 2022.

Share of profit / (loss) of joint venture (net of taxes)

Our share of profit of joint ventures (net of tax) increased to ₹6.66 million for three months ended June 30, 2023 from a loss of ₹1.83 million for three months ended June 30, 2022, primarily due to cost savings and lower expenses.

Tax expense

Our tax expense increased by 286.36% to ₹250.40 million for three months ended June 30, 2023 from ₹64.81 million for three months ended June 30, 2022. This was primarily attributable to an increase in current tax expense to ₹247.25 million for three months ended June 30, 2023 from ₹64.15 million for three months ended June 30, 2022. This was primarily due to an increase in our profit in June 30, 2023.

Profit for the period

For the reasons discussed above, our profit for the period increased by 309.81% to ₹743.48 million for three months ended June 30, 2023 from ₹181.42 million for three months ended June 30, 2022.

Total other comprehensive income for the period, net of taxes

Our total other comprehensive income for the period, net of taxes, was ₹295.47 million for three months ended June 30, 2023 as compared to total other comprehensive loss for the period, net of taxes, of ₹(52.29) million for three months ended June 30, 2022. This was on account of higher fair value gain on investments in equity instruments through other comprehensive income.

Total comprehensive income for the period

Our total comprehensive income for the period increased by 704.58% to ₹1,038.95 million for three months ended June 30, 2023 from ₹129.13 million for three months ended June 30, 2022.

Fiscal 2023 compared to Fiscal 2022

Total income

Our total income increased by 27.11% to ₹56,336.40 million for Fiscal 2023 from ₹44,322.18 million for Fiscal 2022. This increase was due to an increase in revenue from operations.

Revenue from operations. Our revenue from operations increased by 27.66% to ₹55,992.00 million for Fiscal 2023 from ₹43,859.36 million for Fiscal 2022, primarily due to an increase in sale of finished goods to ₹51,046.87 million for Fiscal 2023 from ₹41,082.03 million for Fiscal 2022, an increase in sale of traded goods to ₹4,322.02 million for Fiscal 2023 from ₹2,110.99 million for Fiscal 2022. This was primarily attributable to:

- an increase in revenue from operations from wires and cables segment by 20.61% to ₹49,585.32 million in Fiscal 2023 from ₹41,112.71 million in Fiscal 2022, primarily due to an increase in volume of products sold by 19.60%; and
- an increase in revenue from operations from FMEG segment by 133.00% to ₹6,406.68 million in Fiscal 2023 from ₹2,749.63 million in Fiscal 2022, primarily due to acquisition of the license for the ‘Luminous Fans and Lights’ brand for fan and light products and the corresponding HEB.

This was partially offset by a decrease in other operating revenue to ₹623.11 million for Fiscal 2023 from ₹666.34 million for Fiscal 2022.

Other income. Our other income decreased by 25.59% to ₹344.40 million for Fiscal 2023 from ₹462.82 million for Fiscal 2022, primarily due to a decrease in foreign exchange gain (net) to ₹140.86 million for Fiscal 2023 from ₹265.09 million for Fiscal 2022, a decrease in grant related to property, plant and equipment to ₹1.01 million for Fiscal 2023 from ₹36.92 million for Fiscal 2022 and a decrease in gain on sale of property, plant and equipment (net) to ₹0.80 million for Fiscal 2023 from ₹20.28 million for Fiscal 2022. The grant pertains to custom duty on import of machinery under the Export Promotion of Capital Goods (“EPCG”) scheme. This was partially offset by an increase in interest income on bank deposits to ₹17.34 million for Fiscal 2023 from ₹4.04 million for Fiscal 2022 and a grant related to electricity of ₹25.91 million for Fiscal 2023. There was no corresponding grant received in Fiscal 2022.

Expenses

Cost of materials consumed. Our cost of materials consumed increased by 22.21% to ₹43,697.88 million for Fiscal 2023 from ₹35,755.15 million for Fiscal 2022, primarily due to an increase in raw material consumption on account of higher sales volume.

Purchase of stock-in-trade. Our purchases of stock-in-trade increased by 135.51% to ₹3,688.53 million for Fiscal 2023 from ₹1,566.17 million for Fiscal 2022, relating primarily to increased purchases of FMEG products, such as lights, electric irons, room heaters and water heaters, including pursuant to our acquisition of HEB of ‘Luminous Fans and Lights’ brand.

Changes in inventories of finished goods, stock-in-trade, work-in-progress and scrap. Change in inventories of finished goods, stock-in-trade, work in progress and scrap was a reduction of ₹1,629.40 million for Fiscal 2023 as compared to a reduction of ₹1,241.50 million for Fiscal 2022, primarily attributable to higher closing inventory of finished goods and work in progress.

Employee benefits expense. Employee benefits expense increased by 39.88% to ₹2,641.59 million for Fiscal 2023 from ₹1,888.53 million for Fiscal 2022, primarily due to an increase in the salaries, wages and incentives to ₹2,233.19 million for Fiscal 2023 from ₹1,561.77 million for Fiscal 2022. This was primarily due to an increase in the number of employees from 2,547 in March 31, 2022 to 3,036 in March 31, 2023 in line with overall growth of our operations.

Finance costs. Finance costs increased by 80.75% to ₹420.86 million for Fiscal 2023 from ₹232.84 million for Fiscal 2022, primarily due to an increase in interest on borrowings to ₹354.51 million for Fiscal 2023 from ₹220.83 million for Fiscal 2022. This was primarily attributable to an increase in the interest rate of borrowings and higher utilization of short term working capital loans due to higher working capital requirements as a result of an increase in operations.

Depreciation and amortization expense. Depreciation and amortization expense increased by 29.39% to ₹596.27 million for Fiscal 2023 from ₹460.84 million for Fiscal 2022, primarily due to an increase in depreciation of property, plant and equipment to ₹461.14 million in March 31, 2023 from ₹404.21 million in March 31, 2022.

Other expenses. Our other expenses increased by 52.88% to ₹4,370.20 million for Fiscal 2023 from ₹2,858.53 million for Fiscal 2022, primarily due to:

- an increase in freight and distribution charges to ₹1,155.78 million for Fiscal 2023 from ₹820.20 million for Fiscal 2022, primarily due to increase in volume of products sold;
- an increase in our advertisement and business promotion expenses to ₹851.43 million for Fiscal 2023 from ₹491.29 million for Fiscal 2022, primarily due to our focus on increasing our brand presence;
- an increase in power and fuel expenses to ₹487.93 million for Fiscal 2023 from ₹370.24 million for Fiscal 2022, primarily due to an increase in operations; and
- an increase in travelling expenses to ₹207.04 million for Fiscal 2023 from ₹83.50 million for Fiscal 2022, primarily due to the reduction of COVID-19 travel restrictions.
- An increase in legal and professional fees to ₹260.55 million for Fiscal 2023 from ₹162.95 million for Fiscal 2022, primarily because of the acquisition of HEB of ‘Luminous Fans and Lights’ brand.

Share of profit / (loss) of joint venture (net of taxes)

Our share of profit of joint ventures (net of tax) decreased to ₹9.44 million for Fiscal 2023 from ₹41.97 million for Fiscal 2022, primarily due to foreign exchange fluctuations.

Tax expense

Our tax expense decreased by 6.11% to ₹661.19 million for Fiscal 2023 from ₹704.22 million for Fiscal 2022. This was primarily attributable to a decrease in our profits in Fiscal 2023.

Profit / (loss) for the year

For the reasons discussed above, our profit for the year decreased by 11.25% to ₹1,898.72 million for Fiscal 2023 from ₹2,139.37 million for Fiscal 2022.

Total other comprehensive income for the year, net of taxes

Our total other comprehensive income for the year, net of taxes, decreased by 27.37% to ₹122.81 million for Fiscal 2023 from ₹169.08 million for Fiscal 2022. This was on account of loss on translation of foreign operation.

Total comprehensive income for the period

Our total comprehensive income for the year decreased by 12.43% to ₹2,021.53 million for Fiscal 2023 from ₹2,308.45 million for Fiscal 2022.

Fiscal 2022 compared to Fiscal 2021

Total income

Our total income increased by 61.41% to ₹44,322.18 million for Fiscal 2022 from ₹27,459.36 million for Fiscal 2021. This increase was due to an increase in revenue from operations and other income.

Revenue from operations. Our revenue from operations increased by 61.01% to ₹43,859.36 million for Fiscal 2022 from ₹27,239.41 million for Fiscal 2021, primarily due to an increase in sale of finished goods to ₹41,082.03 million for Fiscal 2022 from ₹25,210.70 million for Fiscal 2021, an increase in sale of traded goods to ₹2,110.99 million for Fiscal 2022 from ₹1,522.61 million for Fiscal 2021 and an increase in other operating revenue to ₹666.34 million for Fiscal 2022 from ₹506.10 million for Fiscal 2021. This was primarily attributable to:

- an increase in revenue from operations from wires and cables segment by 63.13% to ₹41,112.71 million in Fiscal 2022 from ₹25,202.47 million in Fiscal 2021, primarily due to an increase in volume of products sold by 22.86% and pass through of increased raw material prices of copper and aluminum to our customers. Between Fiscals 2021 and 2022, the monthly average LME prices increased by 40.89% and 53.64% for copper and aluminum, respectively; and
- an increase in revenue from operations from FMEG segment by 34.84% to ₹2,746.65 million in Fiscal 2022 from ₹2,036.94 million in Fiscal 2021, primarily due to an increase in volume of fans and lights sold by 35.31%.

Other income. Our other income increased by 110.42% to ₹462.82 million for Fiscal 2022 from ₹219.95 million for Fiscal 2021, primarily due to an increase in foreign exchange gain (net) to ₹265.09 million for Fiscal 2022 from ₹103.53 million for Fiscal 2021, an increase in fair value gain on investment on mutual fund to ₹94.53 million for Fiscal 2022 from ₹40.02 million for Fiscal 2021, an increase in grant related to property, plant and equipment to ₹36.92 million for Fiscal 2022 from ₹0.04 million for Fiscal 2021 and an increase in gain on sale of property, plant and equipment (net) to ₹20.28 million for Fiscal 2022 from ₹0.87 million for Fiscal 2021. The grant pertains to custom duty on import of machinery under the EPCG scheme. This was partially offset by decrease in interest income on bank deposits to ₹4.04 million for Fiscal 2022 from ₹21.44 million for Fiscal 2021 and decrease in gain on sale of mutual fund investments to ₹0.04 million for Fiscal 2022 from ₹32.07 million for Fiscal 2021.

Expenses

Cost of materials consumed. Our cost of materials consumed increased by 64.53% to ₹35,755.15 million for Fiscal 2022 from ₹21,731.99 million for Fiscal 2021, primarily due to an increase in volume of raw material purchased on account of higher sales and an increase in cost of raw materials, including an increase in monthly average LME prices for copper and aluminum.

Purchase of stock-in-trade. Our purchases of stock-in-trade increased by 20.60% to ₹1,566.17 million for Fiscal 2022 from ₹1,298.64 million for Fiscal 2021, relating primarily to increased purchases of FMEG products, such as lights, electric irons, room heaters and water heaters.

Changes in inventories of finished goods, stock-in-trade, work-in-progress and scrap. Change in inventories of finished goods, stock-in-trade, work in progress and scrap was a reduction of ₹1,241.50 million for Fiscal 2022 as compared to a reduction of ₹1,538.45 million for Fiscal 2021, primarily attributable to a higher closing inventory of finished goods and work in progress.

Employee benefits expense. Employee benefits expense increased by 27.31% to ₹1,888.53 million for Fiscal 2022 from ₹1,483.45 million for Fiscal 2021, primarily due to an increase in the salaries, wages and incentives to ₹1,561.77 million for Fiscal 2022 from ₹1,237.13 million for Fiscal 2021. This was primarily due to an increase in the number of employees in the sales and marketing team in line with overall growth of our operations and increasing our brand presence.

Finance costs. Finance costs decreased by 13.94% to ₹232.84 million for Fiscal 2022 from ₹270.56 million for Fiscal 2021, primarily due to a decrease in interest on borrowings to ₹220.83 million for Fiscal 2022 from ₹260.92 million for Fiscal 2021. This was primarily attributable to a decrease in interest rate of borrowings and a better Working Capital Cycle, which improved to 88 days in Fiscal 2022 from 108 days in Fiscal 2021.

Depreciation and amortization expense. Depreciation and amortization expense increased by 2.98% to ₹460.84 million for Fiscal 2022 from ₹447.50 million for Fiscal 2021, primarily due to an increase in depreciation of property, plant and equipment to ₹404.21 million for Fiscal 2022 from ₹398.95 million for Fiscal 2021.

Other expenses. Our other expenses increased by 45.67% to ₹2,858.53 million for Fiscal 2022 from ₹1,962.31 million for Fiscal 2021, primarily due to:

- an increase in freight and distribution charges to ₹820.20 million for Fiscal 2022 from ₹489.72 million for Fiscal 2021, primarily due to an increase in volume of products sold and an increase in fuel charges;
- an increase in our advertisement and business promotion expenses to ₹491.29 million for Fiscal 2022 from ₹259.61 million for Fiscal 2021, primarily due to our focus on increasing our brand presence;
- an increase in power and fuel expenses to ₹370.24 million for Fiscal 2022 from ₹306.62 million for Fiscal 2021, primarily due to an increase in our operations; and
- an increase in warranty expenses to ₹148.18 million for Fiscal 2022 from ₹83.66 million for Fiscal 2021, primarily because we increased our rate of provision in Fiscal 2022.

Share of profit / (loss) of joint venture (net of taxes)

Our share of profit of joint ventures (net of tax) increased to ₹41.97 million for Fiscal 2022 from ₹10.98 million for Fiscal 2021, primarily due to improved operating performance of the joint venture as a result of (i) higher revenues; and (ii) cost optimization leading to lower expenses in Fiscal 2022.

Tax expense

Our tax expense increased by 52.97% to ₹704.22 million for Fiscal 2022 from ₹460.36 million for Fiscal 2021. This was primarily attributable to an increase in our current tax expense to ₹648.27 million for Fiscal 2022 from ₹489.12 million for Fiscal 2021 and a deferred tax charge of ₹52.96 million for Fiscal 2022 as compared to a deferred tax credit of ₹20.87 million for Fiscal 2021. This was primarily due to an increase in our profit for Fiscal 2022.

Profit / (loss) for the year

For the reasons discussed above, our profit for the year increased by 58.01% to ₹2,139.37 million for Fiscal 2022 from ₹1,353.98 million for Fiscal 2021.

Total other comprehensive income for the year, net of taxes

Our total other comprehensive income for the year, net of taxes, increased by 133.03% to ₹167.50 million for Fiscal 2022 from ₹71.88 million for Fiscal 2021. This was on account of a higher fair value gain on certain investments in equity instrument through other comprehensive income.

Total comprehensive income for the period

Our total comprehensive income for the year increased by 61.79% to ₹2,306.87 million for Fiscal 2022 from ₹1,425.86 million for Fiscal 2021.

Cash flows and cash and cash equivalents

The following table sets forth our cash flows and cash and cash equivalents for the period indicated:

(in ₹ million)

	Three months ended June 30,		Fiscals		
	2023	2022	2023	2022	2021
Net cash generated from / (used in) Operating Activities	777.27	1,476.60	4,537.46	981.70	(710.57)
Net cash generated / (used in) Investing Activities	346.76	(1,257.82)	(3,334.97)	(626.55)	(58.80)
Net cash (used in) / generated from Financing Activities	(1,282.97)	(274.71)	(1,015.14)	(316.11)	741.25
Net increase / (decrease) in cash and cash equivalents	(158.94)	(55.93)	187.35	39.04	(28.12)
Cash and cash equivalents at the beginning of the period / year	310.35	123.00	123.00	83.96	112.08
Cash and cash equivalents at the end of the period / year	151.41	67.07	310.35	123.00	83.96

Operating activities

Net cash flows from operating activities aggregated to ₹777.27 million for three months ended June 30, 2023. Our profit before tax of ₹993.88 million, was adjusted primarily for depreciation and amortization expense of ₹160.87 million, finance cost of ₹144.24 million, fair value gain on investment of mutual fund of ₹38.47 million and unrealized foreign exchange gain of ₹28.95 million. Our changes in working capital for three months ended June 30, 2023 primarily consisted of an increase in trade payables of ₹128.23 million, an increase in trade receivables of ₹603.63 million, and a decrease in other assets of ₹135.78 million.

Net cash flows from operating activities aggregated to ₹1,476.60 million for three months ended June 30, 2022. Our profit before tax of ₹246.23 million, was adjusted primarily for depreciation and amortization expense of ₹144.82 million, finance cost of ₹80.77 million, unrealized foreign exchange loss of ₹64.47 million and provisions for warranty expenses of ₹78.64 million. Our changes in working capital for three months ended June 30, 2022 primarily consisted of an increase in trade payables of ₹1,816.90 million, an increase in inventories of ₹976.53 million, an increase in other liabilities and provisions of ₹577.68 million and an increase in other assets of ₹403.62 million.

Net cash flows from operating activities aggregated to ₹4,537.46 million for Fiscal 2023. Our profit before tax of ₹2,559.91 million, was adjusted primarily for depreciation and amortization expense of ₹596.27 million, fair value gain on investment in mutual fund of ₹104.34 million, finance cost of ₹420.87 million, unrealized foreign exchange loss of ₹78.60 million and provisions for warranty expenses of ₹96.49 million. Our changes in working capital for Fiscal 2023 primarily consisted of an increase in inventories of ₹798.79 million, an increase in trade receivables of ₹179.30 million, an increase in trade payables of ₹2,401.13 million, increase in other assets of ₹428.69 million and an increase in other liabilities and provisions of ₹524.42 million.

Net cash flows from operating activities aggregated to ₹981.70 million for Fiscal 2022. Our profit before tax of ₹2,843.59 million, was adjusted primarily for depreciation and amortization expense of ₹460.84 million and finance cost of ₹232.83 million. Our changes in working capital for Fiscal 2022 primarily consisted of an increase in inventories of ₹1,755.66 million, an increase in trade receivables of ₹959.53 million, an increase in trade payables of ₹540.67 million and an increase in other liabilities and provisions of ₹408.13 million.

Net cash flows used in operating activities aggregated to ₹710.57 million for Fiscal 2021. Our profit before tax of ₹1,814.34 million, was adjusted primarily for depreciation and amortization expense of ₹447.50 million and finance cost of ₹270.56 million. Our changes in working capital for Fiscal 2021 primarily consisted of an increase in inventories of ₹1,588.45 million, a decrease in trade payables of ₹667.60 million and an increase in other current assets of ₹424.34 million.

Investing activities

Net cash flows generated from investing activities aggregated to ₹346.76 million for three months ended June 30, 2023, primarily due to ₹476.71 million realization of proceeds from fixed deposits with banks and ₹103.30 million from the redemption of mutual funds. These cash inflows were partially offset by ₹252.19 million for purchase of property, plant and equipment (including capital work-in-progress, capital advances, capital creditors and net off proceeds from sale of property, plant and equipment).

Net cash flows used in investing activities aggregated to ₹1,257.82 million for three months ended June 30, 2022, primarily due to the acquisition of HEB of 'Luminous Fans and Lights' brand for ₹1,095.82 million.

Net cash flows used in investing activities aggregated to ₹3,334.97 million for Fiscal 2023, primarily due to ₹1,083.48 million used for purchase of property, plant and equipment (including capital work-in-progress, capital advances, capital creditors and net off proceeds from sale of property, plant and equipment) and the acquisition of HEB of 'Luminous Fans and Lights' brand for ₹1,095.82 million.

Net cash flows used in investing activities aggregated to ₹626.55 million for Fiscal 2022, primarily due to ₹682.25 million used for purchase of property, plant and equipment (including capital work-in-progress, capital advances, capital creditors and net off proceeds from sale of property, plant and equipment). These cash outflows were partially offset by proceeds from sale of property, plant and equipment of ₹47.18 million.

Net cash flows used in investing activities aggregated to ₹58.80 million for Fiscal 2021, primarily due to ₹474.21 million used for purchase of property, plant and equipment (including capital work-in-progress, capital advances, capital creditors and net

off proceeds from sale of property, plant and equipment). These cash outflows were partially offset by proceeds from fixed deposit with banks of ₹398.67 million.

Financing activities

Net cash flows used in financing activities aggregated to ₹1,282.97 million for three months ended June 30, 2023, primarily due to repayment of both non current and short term borrowings of ₹81.10 million and ₹1,036.59 million, respectively.

Net cash flows used in financing activities aggregated to ₹274.71 million for three months ended June 30, 2022, primarily due to repayment of both non current and short term borrowings of ₹100.53 million and ₹84.54 million, respectively.

Net cash flows used in financing activities aggregated to ₹1,015.14 million for Fiscal 2023, primarily due to repayment of non current borrowings of ₹382.02 million and dividend paid of ₹499.81 million. The cash outflows were partially offset by proceeds from short term borrowings of ₹318.40 million.

Net cash flows used in financing activities aggregated to ₹316.11 million for Fiscal 2022, primarily due to dividend paid of ₹277.67 million and finance costs paid of ₹222.23 million. The cash outflows were partially offset by proceeds from non-current borrowings of ₹338.00 million.

Net cash flows generated from financing activities aggregated to ₹741.25 million for Fiscal 2021, primarily due to proceeds of short term borrowings of ₹863.07 million and proceeds from non-current borrowings of ₹350.00 million. The cash flows were partially offset by finance cost paid of ₹287.46 million.

Indebtedness

The following table sets forth our financial indebtedness as of June 30, 2023:

Particulars	As of June 30, 2023
Non-current borrowings	
Secured loans	
-from banks	187.49
-from financial institution	-
Sub-total	187.49
Current borrowings	
Secured loans	
-from banks	2,806.51
-repayable on demand	20.78
Current maturities of long term borrowings	
-rupee loans	324.43
-vehicle loans	-
Unsecured loans	
-from banks	681.55
Interest accrued	16.89
Sub-total	3,850.16
Total	4,037.65

For further details on our financial indebtedness as of August 28, 2023, see “*Financial Indebtedness*” on page 377.

Liquidity and capital resources

We believe we have sufficient sources of funding to meet our business requirements for the next 12 months and in the longer term. Cash generated by operations, supplemented by external financing such as working capital loans, term loans, letters of credit and packing credit, is our primary source of liquidity for funding our business requirements. Our future capital requirements and the adequacy of available funds will depend on many factors, including those set forth under “*Risk Factors*” on page 28. For the three months ended June 30, 2023, our cash and cash equivalents at the end of the period was ₹151.41 million.

Our short-term funding requirements include working capital requirements. Our long-term funding requirements contemplate investments in manufacturing capacity expansion and strategic inorganic expansion. In the past, we have funded our long-term funding requirements through secured loan term borrowings.

As of June 30, 2023, our estimated amount of contracts remaining to be executed on capital account and not provided for was ₹834.78 million. We have additional obligations as part of our ordinary course of business, beyond those committed for capital expenditures and other purchase obligations and commitments for purchases of goods and services. The expected timing of payments of our obligations is estimated based on current information. Timing of payments and actual amounts paid may be different, depending on the timing of receipt of goods or services, or changes to agreed-upon amounts for some obligations. In addition, some of our purchasing requirements are not current obligations and are therefore not included in the amounts above. For example, some of these requirements are not handled through binding contracts or are fulfilled by vendors on a purchase order basis within short time horizons.

We regularly monitor our liquidity position comprising cash and cash equivalents on the basis of expected cash flows. Our liquidity management policy involves projecting cash flows and considering the level of liquid assets necessary to meet these, monitoring balance sheet liquidity ratios against internal and external regulatory requirements and maintaining debt financing plans. We have net current assets, defined as current assets less current liabilities (“**Working Capital**”) of ₹6,686.91 million, ₹8,123.44 million, ₹8,465.44 million, ₹7,940.83 million and ₹9,002.37 million as at March 31, 2021, March 31, 2022, March 31, 2023, June 30, 2022 and June 30, 2023, respectively.

Capital expenditure

Capital expenditure primarily relates to additions to property, plant and equipment, intangible asset, intangible assets under development (net of addition minus deletion), capital work-in-progress (net of addition minus deletion) and right-to-use asset. The capital expenditure is funded through cash from operations and term loans.

In three months ended June 30, 2023, we incurred capital expenditure of ₹313.90 million, primarily for land held on a freehold basis, manufacturing facilities and plant and machinery.

In three months ended June 30, 2022, we incurred capital expenditure of ₹853.12 million, primarily for acquisition of HEB of ‘Luminous Fans and Lights’ brand, manufacturing facilities and plant and machinery.

In Fiscal 2023, we incurred capital expenditure of ₹1,831.07 million, primarily for acquisition of HEB of ‘Luminous Fans and Lights’ brand, manufacturing facilities and plant and machinery.

In Fiscal 2022, we incurred capital expenditure of ₹846.26 million, primarily for plant and machinery, right-of-use asset and manufacturing facilities.

In Fiscal 2021, we incurred capital expenditure of ₹463.08 million, primarily for plant and machinery, right-of-use asset and manufacturing facilities.

For reconciliation of non-GAAP measures, see “*Other Financial Information – Reconciliation of Non-GAAP Measures*” on page 372.

Capital work-in-progress

As of June 30, 2023, we had capital work-in-progress of ₹497.40 million, compared to ₹435.78 million as of March 31, 2023, ₹423.08 million as of March 31, 2022 and ₹66.81 million as of March 31, 2021. The increase in capital work-in-progress between March 31, 2023 and June 30, 2023 was primarily on account of the construction of a factory building at the Silvassa Facility. The increase in capital work-in-progress between March 31, 2022 and March 31, 2023 was primarily on account of the construction of a worker’s quarter which is offset by the capitalization of the factory building at the Waghodia Facility. The increase in capital work-in-progress between March 31, 2021 and March 31, 2022 was primarily on account of additional expenses incurred in respect of our e-beam project, construction of factory building at the Waghodia Facility and certain plant machinery.

Right-of-use assets

As of June 30, 2023, we had right-of-use assets of ₹663.61 million, compared to ₹618.46 million as of March 31, 2023, ₹111.17 million as of March 31, 2022 and ₹81.48 million as at March 31, 2021. The increase in right-of-use assets between March 31, 2023 and June 30, 2023 was primarily on account of our entry into lease arrangements for warehouses at various locations, including Uttar Pradesh, Odisha, Haryana, Dadra Nagar Haveli, and guesthouse at Chennai. The increase in right-of-use assets between March 31, 2022 and March 31, 2023 was primarily on account of our entry into lease arrangements for the Gagret Facility, office at Gurgaon, corporate office at Vadodara and warehouses at various locations across India. The increase in right-of-use assets between March 31, 2021 and March 31, 2022 was primarily on account of our entry into lease arrangements for warehouses at various locations, including Maharashtra, Haryana and Assam.

Contingent liabilities and commitments

The table sets forth our contingent liabilities as per Ind AS 37 and commitments as at June 30, 2023:

Particulars	As at June 30, 2023
Contingent liabilities	
Claims against our Company not acknowledged as debts	
-Service tax demands	39.20
-Income tax demands	31.71
-Sales tax / Vat demands -C Forms	96.73
-Labor law demand	1.91
Channel financing guarantees	225.00
Total	394.55
Commitments	
On capital account (net of advance)	834.78

(in ₹ million)

For details in relation to our contingent liabilities and commitments as at June 30, 2023, see “*Restated Consolidated Financial Information – Annexure VI – Notes to Restated Consolidated Financial Information – Note 28: Contingent Liabilities and Commitments*” and “*Outstanding Litigation and Material Developments*” on pages 328 and 402, respectively.

Off-balance sheet commitments and arrangements

We do not have any off-balance sheet arrangements, derivative instruments, swap transactions or relationships with affiliates or other unconsolidated entities or financial partnerships that would have been established for the purpose of facilitating off-balance sheet arrangements.

Quantitative and Qualitative Analysis of Market Risks

We are exposed to various types of market risks during the normal course of business. For further details, see “*Risk Factors*” beginning on page 28:

Market risk

Interest rate risk

Interest rate risk is the risk that the fair value or future cash flow of a financial instrument will fluctuate because of changes in market interest rates. We are exposed to interest rate risk on short-term and long-term floating rate interest bearing liabilities. Our policy is to maintain a balance of fixed and floating interest rate borrowings and the proportion of fixed and floating rate debt is determined by prevailing interest rates. These exposures are reviewed by our management on a periodic basis.

Foreign currency risk

We are exposed to fluctuations in foreign currency exchange rates where transaction references more than one currency and/or where assets/liabilities are denominated in a currency other than our functional currency. Our exposure on foreign currency is managed through a hedging policy, which is reviewed periodically by our management. We usually enter into forward exchange contracts progressively based on their maturity to hedge the effects of movements in foreign currency exchange rates individually on assets and liabilities. Our source of foreign exchange risk is trade receivables, trade payables for imported materials and capital goods as well as foreign currency denominated borrowings. We use forward contracts to mitigate the risks associated with foreign currency fluctuations. We do not enter into any forward contracts which are intended for trading or speculative purposes. For further details, see “*-Significant Factors Affecting our Financial Condition and Results of Operations – Fluctuations in exchange rates*” on page 382.

Commodity price risk

We are exposed to the movement of copper and aluminium prices on the LME. Any increase or decline in the prices of these commodities will have an impact on our profitability. For further details, see “*-Significant Factors Affecting our Financial Condition and Results of Operations – Cost and availability of raw materials*” on page 382.

Equity price risk

Equity price risk relates to change in fair value of investments in the equity instruments measured at fair value through other comprehensive income. The price risk arises due to uncertainties about the future market values of these investments and the same is classified in the balance sheet as fair value through other comprehensive income.

Liquidity risk

Liquidity risk refers to the risk that our Company encounters difficulty in raising funds to meet its financial commitments. The objective of liquidity risk management is to maintain the liquidity and to ensure that funds are available for short operational needs and to fund our expansion projects. We have availed credit facility from the banks and financial institutions to meet our financial commitment in timely and cost effective manner.

Credit risk

Credit risk refers to the risk that a counterparty will default on its contractual obligations resulting in financial loss to our Company. We are exposed to credit risk for trade receivables and financial guarantees to dealers, derivative financial instruments and other financial assets. We assess the counter party before entering into transactions and wherever necessary, supplies are delivered against advance payment. We also monitor the credit limit of the counter party to mitigate or minimize the credit risk.

Auditor qualifications and emphasis of matter

There are no auditor qualifications or emphasis of matter which have not been given effect to in the Restated Consolidated Financial Information.

Unusual or infrequent events or transactions

There have been no unusual or infrequent events or transactions that have in the past or may in the future affect our business operations or future financial performance.

Known trends or uncertainties

Our business has been subject, and we expect it to continue to be subject, to significant economic changes arising from the trends identified above in “ - *Significant Factors Affecting our Financial Conditions and Results of Operations*” above and the uncertainties described in “*Risk Factors*” on page 28. Except as disclosed in this Red Herring Prospectus, there are no known factors which we expect to have a material impact on our income.

Future relationship between cost and revenue

Other than as described in “*Risk Factors*” and this section, there are no known factors that might affect the future relationship between cost and revenue.

Related party transactions

We have engaged in the past, and may engage in the future, in transactions with related parties. For details of our related party transactions, see “*Restated Consolidated Financial Information – Annexure VI – Notes to Restated Consolidated Financial Information Note 33: Related party disclosures as required under Ind AS-24*” on page 330.

Working Capital

We believe that our Working Capital (defined as current assets less current liabilities) is sufficient for our present operational requirements.

The Working Capital increased to ₹9,002.37 million in three months ended June 30, 2023 from ₹7,940.83 million in three months ended June 30, 2022 primarily on account of increase in trade receivables by ₹ 930.76 million, and increase in other financial assets by ₹ 87.97 million. This was partially offset by an increase in trade payable by ₹ 722.37 million.

The Working Capital increased to ₹8,465.44 million in Fiscal 2023 from ₹8,123.44 million in Fiscal 2022, primarily on account of surplus generated out of the operations of the Company which resulted in an increase of cash and cash equivalents by ₹ 187.35 million, increase in inventories by ₹ 1,505.56 million and increase in trade receivables by ₹ 747.27 million. This was partially offset by an increase in trade payable by ₹ 2,722.55 million.

The Working Capital increased to ₹8,123.44 million in Fiscal 2022 from ₹6,686.91 million in Fiscal 2021, primarily on account of surplus generated out of the operations of the Company which resulted in an increase of cash and cash equivalents by ₹39.04 million and increase in other financial assets by ₹84.23 million. This was partially offset by an increase in current borrowings by ₹343.67 million and other financial liabilities by ₹75.67 million.

Competitive conditions

We operate in a competitive environment. Please refer to “*Risk Factors*”, “*Industry Overview*” and “*Our Business*” and “- *Significant Factors Affecting Our Results of Operations – Competition*” on pages 28, 139, 190 and 327, respectively, for further information on our industry and competition.

Seasonality and cyclicity of business

Our performance is subject to seasonality. For further details, see “-*Significant Factors Affecting our Results of Operations – Seasonality*” and “*Risk Factors – Our performance is subject to seasonality*” on pages 386 and 59, respectively.

Extent to which material increases in net sales or revenue are due to increased sales volume, introduction of new products or services or increased sales prices

Changes in revenue in Fiscals 2021, 2022 and 2023 and three months ended June 30, 2022 and June 30, 2023 are as described in “- *Fiscal 2022 compared to Fiscal 2021*”, “- *Fiscal 2023 compared to Fiscal 2022*” and “- *Three months ended June 30, 2023 compared to three months ended June 30, 2022*” above on pages 394, 392 and 391, respectively.

Significant dependence on single or few customers

We do not derive revenues from any customers which amount to 10% or more of our revenue in Fiscals 2021, 2022 and 2023 three months ended June 30, 2022 and June 30, 2023.

New products or business segments

Except as disclosed in “*Our Business*” on page 190, and products that we announce in the ordinary course of business, we have not announced and do not expect to announce in the near future any new products or business segments.

Significant developments occurring after June 30, 2023

Except as set out below, to our knowledge, no circumstances have arisen since the date of the last set of financial statements as disclosed in this Red Herring Prospectus, which materially or adversely affect or are likely to affect, our operations or profitability, or the value of our assets or our ability to pay our material liabilities in the next 12 months:

- Pursuant to a resolution passed by our Board on August 14, 2023, a dividend of ₹ 4.5 per equity share and ₹18 per CCPS has been recommended by our Company cumulating to ₹ 499.81 million, subject to approval of our Shareholders in our upcoming annual general meeting on September 14, 2023.

Recent accounting pronouncements

MCA notifies new standard or amendments to the existing standards under Companies (Indian Accounting Standards) Rules, 2015 as issued from time to time. On June 30, 2023, MCA has not notified any new standards or amendments to the existing standards applicable to the Company.

SECTION VI: LEGAL AND OTHER INFORMATION

OUTSTANDING LITIGATION AND MATERIAL DEVELOPMENTS

Except as stated in this section, there are no outstanding (i) criminal proceedings; (ii) actions taken by statutory or regulatory authorities; (iii) claims related to direct and indirect taxes; and (iv) other proceedings which have been determined to be material pursuant to the policy of materiality for identification of material litigation involving our Company, Directors or Promoters (“**Relevant Parties**” and such policy, “**Materiality Policy**”). Further, except as disclosed in this section, there are no disciplinary actions including penalty imposed by the SEBI or stock exchanges against our Promoters in the last five Fiscals. Further, except as disclosed in this section, there are no pending litigation matters involving our Group Companies which have a material impact on our Company or the Offer, as applicable.

For the purpose of (iv) above, our Board in its meeting held on August 30, 2023 has considered and adopted the Materiality Policy. The consolidated profit for the year/period as per the Restated Consolidated Financial Information for Fiscal 2023 was ₹ 1,898.72 million. In terms of the Materiality Policy, the following shall be considered material litigation for the purposes of disclosure in this Red Herring Prospectus:

- a) all outstanding litigation involving the Relevant Parties in which the aggregate monetary amount of claim by or against the Relevant Parties (individually or in the aggregate) in any such pending litigation or arbitration proceeding or taxation proceeding is equivalent to or in excess of 1% of the consolidated profit after tax as per the Restated Consolidated Financial Information for Fiscal 2023, would be considered ‘material’ for disclosure in this Red Herring Prospectus. Based on the above, ₹ 18.99 million, which is 1% of the consolidated profit after tax of our Company as per the Restated Consolidated Financial Information of our Company for Fiscal 2023, has been considered as the materiality threshold;
- b) any pending litigations involving the Relevant Parties where the decision in one litigation is likely to affect the decision in similar litigations, even though the amount involved in an individual litigation may not exceed ₹ 18.99 million; and
- c) all outstanding litigation which may not meet the monetary threshold, or wherein a monetary liability is not quantifiable, but where an adverse outcome would materially and adversely affect the business, operations, performance, prospects, financial position, or reputation of our Company.

Except as stated in this section, there are no outstanding material dues to creditors of our Company. For this purpose, in terms of our Materiality Policy, outstanding dues to any creditor of our Company having a monetary value which is equal to or exceeds 5% of the total outstanding dues to creditors of our Company as on the date of the latest Restated Consolidated Financial Information of our Company shall be considered as ‘material’. The total outstanding dues to creditors as on June 30, 2023 based on the Restated Consolidated Financial Information of our Company was ₹3,951.06 million. Accordingly, any outstanding dues to creditors exceeding ₹197.55 million which is 5% of total outstanding dues to creditors of our Company as on June 30, 2023 based on the Restated Consolidated Financial Information of our Company, have been considered as material outstanding dues for the purposes of disclosure in this section. Further, for outstanding dues to any party which is a micro, small or a medium enterprise (“**MSME**”) and other creditors, the disclosure will be based on information available with our Company regarding the status of the creditor as defined under the Micro, Small and Medium Enterprises Development Act, 2006, as amended, read with the rules and notifications thereunder.

For the purposes of the above, pre-litigation notices received by the Relevant Parties from third parties (excluding governmental / statutory / regulatory / judicial authorities or notices threatening criminal action) shall, in any event, not be considered as litigation until such time that the Relevant Parties are impleaded as defendants in proceedings initiated before any court, tribunal or governmental authority.

We have disclosed matters relating to direct and indirect taxes involving the Relevant Parties (as applicable) in a consolidated manner giving details of number of cases and total amount involved in such claims and details of such matters wherein the amount involved exceeds the materiality threshold specified above.

All terms defined in a particular litigation disclosure below correspond to that particular litigation only.

Litigation involving our Company

I. Litigation against our Company

Criminal litigation

Nil

Material civil litigation

Nil

Actions taken by regulatory and statutory authorities

1. Our Company received a notice dated January 27, 2023 from the National Investigation Agency, Ministry of Home Affairs, Government of India (“**Agency**”) in relation to certain ongoing criminal investigation against Vipin Mittal and others, requiring our Company to be present before the Agency and provide certain responses and documents in relation to payments received from a third party for the sale of our products to a long standing customer. Our Company provided the relevant documents sought by the Agency. Subsequently, the Agency requested our Company to provide information in relation to *inter alia* the export of goods and their procurement, import of goods and their subsequent sale in India and delivery of goods purchased and sold by our Company, as well as the copies of the sales register, purchase register and stock registers of our Company for the financial years ended March 31, 2022 and March 31, 2023, and our Company has provided the relevant information and documents to the Agency. No further communication from the Agency has been received by our Company in this regard. Further, Vipin Mittal is not related, in any manner, to our Company, Promoters, Directors or members of our Promoter Group.

Tax litigation

1. The Office of the Assistant Commissioner, Central GST and Central Excise, Vadodara-I (“**Assistant Commissioner**”) issued a notice dated September 14, 2022 (“**Notice I**”), to our Company in relation to a refund claim amounting to ₹55.47 million submitted by our Company for the tax period of August 2017. Pursuant to Notice I, the Assistant Commissioner alleged *inter alia* that our Company was only eligible for a maximum refund amounting to ₹24.19 million and that our Company had claimed approximately ₹31.27 million in excess of the eligible amount. Accordingly, the Assistant Commissioner directed that the said amount be refunded with applicable interest and penalty. Our Company in its response dated October 10, 2022 to Notice I submitted *inter alia* that a refund amounting to ₹55.04 million had been duly sanctioned pursuant to an order dated April 26, 2018 by the Assistant Commissioner and that such refund was not erroneous. Subsequently, the office of the Joint Commissioner, Central Tax, GST Division – VII, Vadodara – I (“**Joint Commissioner**”) issued an intimation of liability in Form GST DRC-01A dated December 12, 2022, stating that our Company was liable to pay an erroneously refunded amount of ₹30.85 million with applicable interest; to which our Company submitted a response on December 13, 2022 stating that the liability was not acceptable and that the refund was in accordance with law. Thereafter, the Office of the Principal Commissioner, Central GST and Central Excise, Vadodara-I (“**Principal Commissioner**”) also issued a show cause cum demand notice dated December 28, 2022 (“**Notice II**”), requiring *inter alia* our Company to show cause as to why the refund of ₹30.85 million should not be demanded and recovered from our Company, along with interest and penalty. Our Company was further issued Form GST DRC-01 on January 12, 2023 in relation to the matter. Our Company in its replies dated February 15, 2023 and March 3, 2023 submitted *inter alia* that it was not liable to pay any refund or interest or penalty and that it should be afforded a personal hearing in the matter. Further, our Company also submitted that it had deposited the amount sought to be recovered under protest on January 30, 2023. Subsequently, the Additional Commissioner, Central GST and Central Excise, Vadodara-I issued an order dated March 27, 2023 (“**Order**”), ordering the recovery of refund amounting to ₹30.85 million along with interest and a penalty of ₹3.09 million from our Company. Subsequently, our Company has filed an appeal before the Commissioner of GST and Central Excise (Appeals) on June 12, 2023 challenging the Order. The matter is currently pending.
2. The Deputy Commissioner of Value Added Tax, Dadra and Nagar Haveli (“**Deputy Commissioner**”) issued a notice of default assessment of tax and interest dated November 25, 2016 to our Company for the assessment year 2012-2013, raising a tax demand amounting to ₹27,787 including interest payable by our Company for *inter alia* non-submission of declaration form ‘C’. Subsequently, the Deputy Commissioner issued a notice of default reassessment dated September 2, 2020 (“**Default Reassessment Notice**”), stating that our Company was liable to pay a demand amounting to ₹92.21 million for non-verification of forms for assessment year 2012-2013, against which a withheld refund amounting to ₹2.64 million was adjusted to create a net tax demand amounting to ₹89.57 million payable by our Company. Aggrieved by the Default Reassessment Notice, our Company filed an appeal before the Joint Commissioner of Value Added Tax, Dadra and Nagar Haveli and Daman and Diu (“**Joint Commissioner**”) on November 2, 2020 (“**Appeal**”), praying *inter alia* that the Default Reassessment Notice and the tax demand amounting to ₹89.57 million be quashed and set aside and that the withheld refund amounting to ₹2.64 million be granted to our Company with interest. The Joint Commissioner in its order dated February 15, 2021 disposed of the Appeal and directed the Deputy Commissioner to re-verify the forms submitted by our Company. The process of re-verification of the forms is currently pending.
3. The Office of the Commissioner, Central Goods and Service Tax and Central Excise, Audit, Surat (“**Commissioner**”) issued a show cause notice dated May 27, 2022 (“**Notice**”) to our Company, alleging *inter alia* that our Company had availed input tax credit amounting to ₹ 20.63 million in relation to certain support

services received by our manufacturing units from the head office of our Company, without the actual receipt of such services. Accordingly, the Notice required our Company to show cause as to why goods and service tax amounting to ₹ 20.63 million should not be recovered from our Company under the provisions of the Central Goods and Services Tax Act, 2017, along with interest and penalty. Our Company in its reply dated June 29, 2022 submitted *inter alia* that our head office had provided the relevant services to our manufacturing units and that the input tax credit had been rightly claimed by our Company. The matter is currently pending.

II. *Litigation by our Company*

Criminal litigation

1. Vikram Krushnakumar Ravat, an employee of our Company, filed a first information report dated April 1, 2021 against Arjun Hraday Ram, Sukhvinder Singh Makhansing, Sukhlal Kumawat, Laduram Bhomaram Gajjar and Santosh Vijaykant Jageshar (“**Accused**”) at the Waghodia police station, under Sections 114, 120B and 407 of the Indian Penal Code, 1860, alleging *inter alia* that the Accused had stolen cables that were to be exported by our Company. The matter is currently pending.
2. Subhashbhai Jerambhai Nakum, an employee of our Company, filed a first information report dated July 6, 2022 against Hemantbhai Ramanbhai Vasava and Jigarbhai Firozbhai Parmar (“**Accused**”) at the Waghodia police station, under Sections 114, 120B and 381 of the Indian Penal Code, 1860, alleging *inter alia* that the Accused were contractual employees that had continuously stolen copper wires from our Company’s plant. The matter is currently pending.
3. Adipsing Chandansinh Kharola, an employee of our Company, filed a first information report dated January 17, 2023 against certain unknown persons (“**Accused**”) at the Waghodia police station, under Sections 380 and 457 of the Indian Penal Code, 1860, alleging *inter alia* that the Accused had broken down the iron grill fixed on the Company’s wall, committed trespass and stolen copper wires from the premises of our Company. The matter is currently pending.
4. Our Company and Ram Ratna Electricals Limited (now amalgamated with our Company) (“**RREL**”) have filed 205 cases before various forums for alleged violations of Section 138 of the Negotiable Instruments Act, 1881 in relation to dishonour of cheques and the recovery of amounts due to our Company and RREL. The total amount involved in these matters aggregates to approximately ₹188.09 million. These matters are currently pending.

Material civil litigation

1. Our Company had supplied and delivered PVC insulated high voltage cables, telephone cables and coaxial cables to Govind Electrica Private Limited (“**Debtor**”). Since the Debtor failed to make certain outstanding payments towards our Company on account of dishonour of cheques, our Company initiated proceedings under Sections 138 and 142 of the Negotiable Instruments Act, 1881. Our Company also submitted a claim against the Debtor on October 4, 2022 in an ongoing corporate insolvency resolution process initiated against the Debtor under the Insolvency and Bankruptcy Code, 2016, for an aggregate amount of ₹36.43 million (including interest). The claim was admitted by the interim resolution professional on October 12, 2022. The matter is currently pending.
2. Our Company had supplied PVC insulation cables to Millennium Mall, a partnership firm and its partners, Manish Ramniklal Mehta and Asha Manish Mehta (collectively, “**Defendants**”) on credit from December 4, 2009 to January 15, 2014, worth ₹182.03 million, out of which a principal amount of ₹11.18 million remained outstanding to be paid to our Company. Since the Defendants denied to make payment towards the outstanding principal amount and applicable interest, our Company filed a commercial suit before the Civil Judge, Dadra and Nagar Haveli at Silvassa on January 7, 2017 against the Defendants for *inter alia* recovery of ₹20.26 million (including interest) from the Defendants. Pursuant to an order dated March 12, 2021 issued by the Principal District Judge, Dadra and Nagar Haveli at Silvassa, the matter has been transferred before the Civil Judge (Senior Division), Dadra and Nagar Haveli at Silvassa. The matter is currently pending.

Litigation involving our Promoters

I. *Litigation against our Promoters*

Criminal Litigation

Nil

Material civil litigation

Nil

Actions taken by regulatory and statutory authorities

Nil

Disciplinary actions including penalties imposed by SEBI or the Stock Exchanges in the last five Financial Years preceding the date of this Red Herring Prospectus

Nil

II. Litigation by our Promoters

Criminal litigation

Nil

Civil litigation

Nil

Litigation involving our Directors

I. Litigation against our Directors

Criminal litigation

Nil

Material civil litigation

Nil

Actions taken by regulatory and statutory authorities

Nil

II. Litigation by our Directors

Criminal litigation

Nil

Material civil litigation

Nil

Litigation involving our Group Companies

As on the date of this Red Herring Prospectus, there is no pending litigation involving our Group Companies which will have a material impact on our Company or the Offer, as applicable.

Tax matters

Except as disclosed below, there are no proceedings related to direct and/ or indirect taxes pending against our Company, Promoters and Directors:

Nature of case	Number of cases	Amount involved (in ₹ million)*
Our Company		
Direct tax	10	32.55
Indirect tax	29 [^]	252.91
Our Promoters		
Direct tax	Nil	Nil
Indirect tax	Nil	Nil
Our Directors		
Direct tax	Nil	Nil
Indirect tax	Nil	Nil

* To the extent ascertainable. The amount in dispute is to the extent quantifiable as per notice of demand and excluding any further liabilities towards interest and penalty.

[^] Including the disclosures under “– Litigation involving our Company – Litigation against our Company – Tax litigation” on page 403.

Outstanding dues to creditors

Pursuant to the resolution passed by our Board on August 30, 2023, creditors of our Company to whom an amount equal to or exceeding 5% of our total outstanding dues to creditors as of June 30, 2023 based on the Restated Consolidated Financial Information of our Company was outstanding, were considered 'material' creditors. As per the Restated Consolidated Financial Information, our total outstanding dues to creditors as of June 30, 2023, was ₹3,951.06 million and accordingly, creditors to whom outstanding dues exceed ₹197.55 million have been considered as material creditors for the purposes of disclosure in this Red Herring Prospectus.

Based on this criteria, details of outstanding dues owed to creditors as of June 30, 2023 by our Company are set out below:

Type of creditors	Number of creditors	Amount due (in ₹ million)
Micro, Small and Medium Enterprises	214	323.83
Material creditors	2	2,577.23
Other creditors	1,220	1,050.00
Total	1,436	3,951.06

The details pertaining to outstanding dues towards our material creditors are available on the website of our Company at www.rrkabel.com/investor/others.

Material Developments

Except as disclosed in “*Management’s Discussion and Analysis of Financial Condition and Results of Operations – Significant developments occurring after June 30, 2023*” on page 401 and in this Red Herring Prospectus, there have not arisen, since the date of the last financial information disclosed in this Red Herring Prospectus, any circumstances which materially and adversely affect, or are likely to affect, our operations, our profitability taken as a whole or the value of our consolidated assets or our ability to pay our liabilities within the next 12 months.

GOVERNMENT AND OTHER APPROVALS

We have set out below a list of material approvals, consents, licences, registrations, and permissions from various governmental and regulatory authorities required to be obtained by our Company which are considered material and necessary for the purpose of undertaking our business activities and operations (“**Material Approvals**”). In view of the approvals listed below, our Company can undertake this Offer and its business activities and operations, as applicable. In addition, certain Material Approvals of our Company may have lapsed or expired or may lapse in their ordinary course of business, from time to time, and our Company has either already made applications to the appropriate authorities for renewal of such Material Approvals or is in the process of making such renewal applications in accordance with applicable law and requirements and procedures. Unless otherwise stated, Material Approvals as set out below, are valid as on date of this Red Herring Prospectus.

We have also set forth below (i) Material Approvals or renewals applied for but not received; (ii) Material Approvals expired and renewal yet to be applied for; and (iii) Material Approvals required however yet to be obtained or applied for, as on the date of this Red Herring Prospectus. For details of risk associated with not obtaining or delay in obtaining the requisite approvals, see “Risk Factors – Internal Risk Factors- We are subject to various laws and extensive government regulations and if we fail to obtain, maintain or renew our statutory and regulatory licenses, permits and approvals required in the ordinary course of our business, including environmental, health and safety laws and other regulations, our business financial condition, results of operations and cash flows may be adversely affected.” on page 49.

For further details in connection with the applicable regulatory and legal framework within which we operate, see “Key Regulations and Policies” beginning on page 229.

I. Approvals in relation to the Offer

For the approvals and authorisations obtained by our Company in relation to the Offer, see “Other Regulatory and Statutory Disclosures – Authority for the Offer” on page 409.

II. Incorporation related approvals of our Company

1. Certificate of incorporation dated February 6, 1995, under the name ‘Ram Ratna Agro-Plast Limited’ issued by the RoC to our Company.
2. Fresh certificate of incorporation dated November 8, 2000 issued by the RoC to our Company consequent upon change of name to ‘R R Kabel Limited’.
3. The CIN of our Company is U28997MH1995PLC085294.

III. Material Approvals in relation to the business and operations of our Company:

1. Factory license issued by the designated authorities under the Factories Act, 1948 for our manufacturing facilities.
2. Consolidated consent and authorisation issued by various state pollution control boards under the Water (Prevention and Control of Pollution) Act, 1974, Air (Prevention and Control of Pollution) Act, 1981 and Hazardous and Other Wastes (Management and Transboundary Movement) Rules, 2016 in relation to our manufacturing facilities.
3. No objection certificate issued by the relevant state fire departments for our manufacturing facilities.
4. Certificate of verification verifying and stamping the weights and measures in relation to our manufacturing facilities issued by the Office of the Controller/ Inspector, Legal Metrology under the Legal Metrology Act, 2009.
5. Licence to use the standard mark in respect of the products of our Company issued by the Bureau of Indian Standards under the Bureau of Indian Standards (Certification) Regulations, 1988.

IV. Labour related Material Approvals

1. Certificate of registration as a principal employer issued by the designated authorities under the Contract Labour (Regulation and Abolition) Act, 1970 for engaging labourers in various businesses and activities at our manufacturing facilities, wherever applicable.
2. Certificate of registration issued by the Employees’ Provident Fund Organisation under the Employees’ Provident Funds and Miscellaneous Provisions Act, 1952.
3. Certificate of registration issued by the Employees’ State Insurance Corporation under the Employees’ State Insurance Act, 1948.

4. Certificates of registration under applicable shops and establishments legislations issued by the ministry or department of labour of the relevant state government for our Registered Office, Corporate Office and other offices and warehouses.

V. Tax related Material Approvals

1. Permanent account number issued by the Income Tax Department, Government of India under the Income Tax Act, 1961.
2. Tax deduction account number issued by the Income Tax Department, Government of India under the Income Tax Act, 1961.
3. Certificate of registration issued by the Central Government for enrolment as existing taxpayer for GST under the Goods and Services Tax Act, 2017.
4. Certificate of registration issued by the respective tax authorities of relevant states under the relevant professions, trades, callings and employments statutes to enable payment of profession tax by our Company.

VI. Export related international Material Approvals

Material certifications and approvals in relation to the export of our Company's products to foreign jurisdictions from the appropriate regulatory authorities in such jurisdictions, where these certifications and approvals are mandatory for the export of our Company's products.

VII. Certain other Material Approvals

1. Certificate of Importer-Exporter Code issued by the Office of Additional Director General of Foreign Trade under the Foreign Trade (Development and Regulation) Act, 1992.

VIII. Material Approvals or renewals applied for but not received by our Company

1. Application for factory license issued under the Factories Act, 1948, for our facility in Gagret, acquired from Luminous Power Technologies Private Limited.
2. Application for certificate of verification verifying and stamping the weights and measures in relation to our manufacturing facility in Silvassa, issued by the Office of the Controller/ Inspector, Legal Metrology under the Legal Metrology Act, 2009.
3. Application for certificate of registration issued by the respective tax authority of Kerala under the relevant professions, trades, callings and employments statute to enable payment of profession tax by our Company for our office and warehouse in the state of Kerala.

IX. Material Approvals expired and renewal yet to be applied for by our Company

Nil

X. Material Approvals required however yet to be obtained or applied for by our Company

1. Licence to use the standard mark in respect of the products of our Company issued by the Bureau of Indian Standards under the Bureau of Indian Standards (Certification) Regulations, 1988 for our facility in Gagret.
2. Certificate of registration issued by the respective tax authority of Gujarat under the relevant professions, trades, callings and employments statute to enable payment of profession tax by our Company for our warehouse in the state of Gujarat.

XI. Intellectual property rights

For further details, see "*Our Business*" on page 190 and "*Risk Factors – If we are unable to maintain and enhance our brands, including our ability to protect our brand through intellectual property, the sales of our products will suffer, which would have a material adverse effect on our results of operations. We may also unintentionally infringe upon the intellectual property rights of others, any misappropriation of which could harm our competitive position.*" on page 24.

OTHER REGULATORY AND STATUTORY DISCLOSURES

Authority for the Offer

The Offer (including the Fresh Issue) has been authorised by our Board pursuant to resolutions passed at their meetings held on February 13, 2023, and by our Shareholders pursuant to a special resolution dated March 20, 2023. Further, our Board has taken on record the consents of the Selling Shareholders to participate in the Offer for Sale, pursuant to its resolution dated May 5, 2023. Our Board has approved the Draft Red Herring Prospectus pursuant to their resolution dated May 5, 2023 and has approved this Red Herring Prospectus pursuant to its resolution dated September 6, 2023.

Each of the Selling Shareholders, severally and not jointly, has authorised and confirmed its participation in the Offer for Sale in relation to its portion of the Offered Shares, as set out below:

Selling Shareholders	Number of Offered Shares	Date of consent letter	Date of corporate authorisation/ board resolution
Mahendrakumar Rameshwarlal Kabra	Up to 754,417 Equity Shares	May 5, 2023	N.A.
Hemant Mahendrakumar Kabra	Up to 754,417 Equity Shares	May 5, 2023	N.A.
Sumeet Mahendrakumar Kabra	Up to 754,417 Equity Shares	August 31, 2023	N.A.
Kabel Buildcon Solutions Private Limited	Up to 707,200 Equity Shares	May 5, 2023	March 18, 2023
Ram Ratna Wires Limited	Up to 1,364,480 Equity Shares	May 5, 2023	April 12, 2023
TPG Asia VII SF Pte. Ltd.	Up to 12,901,877 Equity Shares	August 31, 2023	March 9, 2023

Our Company has received in-principle approvals from BSE and NSE for the listing of the Equity Shares pursuant to letters dated June 9, 2023, each.

Prohibition by SEBI or other governmental authorities

Our Company, our Promoters, members of our Promoter Group, our Directors, or persons in control of our Company and the Selling Shareholders, are not prohibited from accessing the capital market or debarred from buying, selling or dealing in securities under any order or direction passed by SEBI or any securities market regulator in any other jurisdiction or any other authority/court.

Our Directors and Promoters are not directors or promoters of any other company which has been debarred from accessing the capital markets by SEBI.

Our Company, Promoters and Directors have not been declared as Wilful Defaulters or Fraudulent Borrowers by any bank or financial institution or consortium thereof in accordance with the guidelines on Wilful Defaulters or Fraudulent Borrowers issued by the RBI.

Our Promoters or Directors have not been declared as Fugitive Economic Offenders.

Compliance with the Companies (Significant Beneficial Owners) Rules, 2018

Our Company, our Promoters, members of our Promoter Group and the Selling Shareholders, are in compliance with the Companies (Significant Beneficial Owners) Rules, 2018, as amended, to the extent applicable to each of them in respect of its respective holding in our Company as on the date of this Red Herring Prospectus.

Directors associated with the securities market

None of our Directors are associated with the securities market in any manner including securities market related business.

There are no outstanding action(s) initiated by SEBI against our Directors in the five years preceding the date of this Red Herring Prospectus.

Eligibility for the Offer

Our Company is eligible for the Offer in accordance with Regulation 6(1) of the SEBI ICDR Regulations as set out under the eligibility criteria and as derived from the Restated Consolidated Financial Information:

- (a) Our Company has had net tangible assets of at least ₹30.00 million, calculated on a restated and consolidated basis, in each of the preceding three full years (of 12 months each);
- (b) Our Company has an average operating profit of at least ₹150.00 million, calculated on a restated and consolidated basis, during the preceding three years (of 12 months each), with operating profit in each of these preceding three years;

- (c) Our Company has a net worth of at least ₹10.00 million in each of the preceding three full years (of 12 months each), calculated on a restated and consolidated basis; and
- (d) Our Company has not changed its name in the last one year.

Unless stated otherwise, our Company's net tangible assets, operating profits and net worth, have been derived from the Restated Consolidated Financial Information included in this Red Herring Prospectus for the last three Financial Years, which are set forth below:

Derived from our Restated Consolidated Financial Information:

(₹ in million, unless otherwise mentioned below)

Description	As at March 31,		
	2023	2022	2021
Net Tangible Assets, as restated and consolidated (A) ⁽¹⁾	14,132.09	12,460.38	10,408.71
Monetary Assets, as restated and consolidated (B) ⁽²⁾	310.35	123	83.96
Operating Profit, as restated and consolidated (C) ⁽³⁾	2,636.37	2,613.61	1,864.95
Net Worth, as restated and consolidated (D) ⁽⁴⁾	13,904.74	12,370.47	10,333.75
Monetary Assets, as restated and consolidated as a % of Net Tangible Assets, as restated and consolidated (E)=(B)/(A) (in %) ⁽⁵⁾	2.20	0.99	0.81

Source: Restated Consolidated Statement of Assets and Liabilities and Restated Consolidated Statement of Profit and Loss of the Company as included in this Red Herring Prospectus under the section "Financial Statements".

- (1) Net Tangible Assets, Restated and consolidated, mean the sum of all net assets of the Issuer and excluding intangible assets, each on restated basis and as defined in Indian Accounting Standard 38.
- (2) Restated and consolidated Monetary Assets = Cash and cash equivalents on restated and consolidated basis.
- (3) Restated and consolidated Operating Profit has been calculated as restated and consolidated profit before tax excluding other income and finance cost each on a restated and consolidated basis.
- (4) Net Worth has been defined as restated and consolidated net worth, which is the aggregate value of the paid-up share capital and all reserves created out of the profits and securities premium account and debit or credit balance of profit and loss account, after deducting the aggregate value of the accumulated losses, deferred expenditure and miscellaneous expenditure not written off, as per the restated consolidated statement of assets and liabilities, but does not include reserves created out of revaluation of assets, write-back of depreciation and amalgamation. Further, capital redemption reserve, capital reserve and share suspense account have been excluded when computing other equity since these were not created out of the profits.
- (5) 'Monetary Assets as restated as a percentage of the Net Tangible Assets' means Monetary Assets as restated divided by Net Tangible Assets, as restated, expressed as a percentage.

The average Operating Profit, as restated and consolidated for the last three Financial Years is ₹2,045.86 million

Further, our Company confirms that it is not ineligible to make the Offer in terms of Regulation 5 of the SEBI ICDR Regulations, to the extent applicable. Our Company is in compliance with the conditions specified in Regulation 5 of the SEBI ICDR Regulations. The details of our compliance with Regulation 5 of the SEBI ICDR Regulations are as follows:

- (a) None of our Company, our Promoters, members of our Promoter Group, our Directors or the Selling Shareholders are debarred from accessing the capital markets by the SEBI.
- (b) None of our Promoters or Directors are promoters or directors of companies which are debarred from accessing the capital markets by the SEBI.
- (c) None of our Company, our Promoters or Directors is a Wilful Defaulter or Fraudulent Borrower.
- (d) None of our Promoters or Directors has been declared a Fugitive Economic Offender in accordance with the Fugitive Economic Offenders Act, 2018.
- (e) Except for the options granted pursuant to ESOP Schemes, there are no outstanding convertible securities, warrants, options or rights to convert debentures, loans or other instruments convertible into, or which would entitle any person any option to receive Equity Shares, as on the date of this Red Herring Prospectus. For further information on the ESOP Schemes of our Company, see "Capital Structure – Employee Stock Option Schemes of our Company" on page 106 and for further information on the Preferences Shares issued by our Company, see "Capital Structure – Notes to the Capital Structure- Preference share capital history of our Company" on page 88.

Each of the Selling Shareholders, severally and not jointly specifically confirm that the Equity Shares being offered by each of the Selling Shareholders comply with the requirements specified under Regulation 8 of the SEBI ICDR Regulations and accordingly, are eligible for the Offer in accordance with the provisions of the SEBI ICDR Regulations.

Our Company confirms that it is also in compliance with the conditions specified in Regulation 7(1) of the SEBI ICDR Regulations, to the extent applicable, and will ensure compliance with the conditions specified in Regulation 7(2) of the SEBI ICDR Regulations, to the extent applicable.

We are eligible to undertake the Offer as per Rule 19(2)(b) of the SCRR read with Regulations 6(1) of the SEBI ICDR Regulations. Accordingly, in accordance with Regulation 32(1) of the SEBI ICDR Regulations we are required to allot not more than 50% of the Net Offer to QIBs. Further, subject to availability of Equity Shares in the respective categories, not less

than 15% of the Net Offer shall be available for allocation to Non-Institutional Bidders and not less than 35% of the Net Offer shall be available for allocation to RIBs, in accordance with the SEBI ICDR Regulations, subject to valid Bids being received at or above the Offer Price. In the event we fail to do so, the full application money shall be refunded to the Bidders.

Further, in terms of Regulation 49(1) of the SEBI ICDR Regulations, our Company shall ensure that the number of Bidders to whom the Equity Shares will be Allotted will be not less than 1,000 and should our Company fail to do so, the Bid Amounts received by our Company shall be refunded to the Bidders, in accordance with the SEBI ICDR Regulations and applicable law.

DISCLAIMER CLAUSE OF SEBI

IT IS TO BE DISTINCTLY UNDERSTOOD THAT SUBMISSION OF THE DRAFT RED HERRING PROSPECTUS TO SEBI SHOULD NOT, IN ANY WAY, BE DEEMED OR CONSTRUED THAT THE SAME HAS BEEN CLEARED OR APPROVED BY SEBI. SEBI DOES NOT TAKE ANY RESPONSIBILITY EITHER FOR THE FINANCIAL SOUNDNESS OF ANY SCHEME OR THE PROJECT FOR WHICH THE OFFER IS PROPOSED TO BE MADE OR FOR THE CORRECTNESS OF THE STATEMENTS MADE OR OPINIONS EXPRESSED IN THE DRAFT RED HERRING PROSPECTUS. THE BOOK RUNNING LEAD MANAGERS, AXIS CAPITAL LIMITED, CITIGROUP GLOBAL MARKETS INDIA PRIVATE LIMITED, HSBC SECURITIES AND CAPITAL MARKETS (INDIA) PRIVATE LIMITED AND JM FINANCIAL LIMITED, HAVE CERTIFIED THAT THE DISCLOSURES MADE IN THE DRAFT RED HERRING PROSPECTUS ARE GENERALLY ADEQUATE AND ARE IN CONFORMITY WITH THE SECURITIES AND EXCHANGE BOARD OF INDIA (ISSUE OF CAPITAL AND DISCLOSURE REQUIREMENTS) REGULATIONS, 2018, AS AMENDED. THIS REQUIREMENT IS TO FACILITATE INVESTORS TO TAKE AN INFORMED DECISION FOR MAKING AN INVESTMENT IN THE PROPOSED OFFER.

IT SHOULD ALSO BE CLEARLY UNDERSTOOD THAT WHILE OUR COMPANY IS PRIMARILY RESPONSIBLE FOR THE CORRECTNESS, ADEQUACY AND DISCLOSURE OF ALL RELEVANT INFORMATION IN THE DRAFT RED HERRING PROSPECTUS AND EACH OF THE SELLING SHAREHOLDERS WILL BE RESPONSIBLE ONLY FOR THE STATEMENTS SPECIFICALLY CONFIRMED OR UNDERTAKEN BY IT IN THE DRAFT RED HERRING PROSPECTUS IN RELATION TO ITSELF OR ITS RESPECTIVE PORTION OF THE OFFERED SHARES, THE BOOK RUNNING LEAD MANAGERS ARE EXPECTED TO EXERCISE DUE DILIGENCE TO ENSURE THAT OUR COMPANY AND THE SELLING SHAREHOLDERS DISCHARGE THEIR RESPONSIBILITY ADEQUATELY IN THIS BEHALF AND TOWARDS THIS PURPOSE, THE BOOK RUNNING LEAD MANAGERS HAVE FURNISHED TO SEBI, A DUE DILIGENCE CERTIFICATE DATED MAY 5, 2023, IN THE FORMAT PRESCRIBED UNDER SCHEDULE V(A) OF THE SECURITIES AND EXCHANGE BOARD OF INDIA (ISSUE OF CAPITAL AND DISCLOSURE REQUIREMENTS) REGULATIONS, 2018, AS AMENDED.

THE FILING OF THIS RED HERRING PROSPECTUS DOES NOT, HOWEVER, ABSOLVE OUR COMPANY FROM ANY LIABILITIES UNDER THE COMPANIES ACT, 2013 OR FROM THE REQUIREMENT OF OBTAINING SUCH STATUTORY AND/OR OTHER CLEARANCES AS MAY BE REQUIRED FOR THE PURPOSE OF THE OFFER. SEBI FURTHER RESERVES THE RIGHT TO TAKE UP, AT ANY POINT OF TIME, WITH THE BOOK RUNNING LEAD MANAGERS, ANY IRREGULARITIES OR LAPSES IN THIS RED HERRING PROSPECTUS.

All legal requirements pertaining to the Offer have been complied with at the time of filing of this Red Herring Prospectus with the RoC in terms of Section 32 of the Companies Act. All legal requirements pertaining to the Offer will be complied with at the time of filing of the Prospectus with the RoC in terms of Sections 26, 33(1) and 33(2) of the Companies Act.

Disclaimer from our Company, the Directors, the Selling Shareholders, the Book Running Lead Managers

Our Company, the Directors, the Selling Shareholders, the Book Running Lead Managers accept no responsibility for statements made otherwise than in this Red Herring Prospectus or in the advertisements or any other material issued by or at our Company's instance and anyone placing reliance on any other source of information, including our Company's website, www.rrkabel.com, or the respective websites of any affiliate of our Company would be doing so at his or her own risk. The Selling Shareholders, including their respective directors, affiliates, associates and officers, accept or undertake no responsibility for any statements made or undertakings provided in this Red Herring Prospectus other than those specifically undertaken or made or confirmed in relation to itself as a Selling Shareholder and its respective portion of the Offered Shares.

The Book Running Lead Managers accept no responsibility, save to the limited extent as provided in the Offer Agreement and the Underwriting Agreement to be entered into among the Underwriters, the Selling Shareholders and our Company.

All information, to the extent required in relation to the Offer, shall be made available by our Company, each of the Selling Shareholders, severally and not jointly (to the extent that the information pertain to itself and its respective portion of the Offered Shares), the Book Running Lead Managers to the public and investors at large and no selective or additional information would be available for a section of the investors in any manner whatsoever, including at road show presentations, in research or sales reports, at Bidding Centres or elsewhere.

None among our Company, the Selling Shareholders or any member of the Syndicate is liable for any failure in uploading the Bids due to faults in any software/ hardware system or otherwise; the blocking of Bid Amount in the ASBA Account on receipt of instructions from the Sponsor Banks on account of any errors, omissions or noncompliance by various parties involved in, or any other fault, malfunctioning or breakdown in, or otherwise, in the UPI Mechanism.

Bidders will be required to confirm and will be deemed to have represented to our Company, the Selling Shareholders, Underwriters and their respective directors, partners, officers, agents, affiliates, and representatives that they are eligible under all applicable laws, rules, regulations, guidelines and approvals to acquire the Equity Shares and will not issue, allot, sell, pledge, or transfer the Equity Shares to any person who is not eligible under any applicable laws, rules, regulations, guidelines and approvals to acquire the Equity Shares. Our Company, the Selling Shareholders, Underwriters and their respective directors, partners, officers, agents, affiliates, and representatives accept no responsibility or liability for advising any investor on whether such investor is eligible to acquire the Equity Shares.

The Book Running Lead Managers and their respective associates and affiliates may engage in transactions with, and perform services for, our Company, the Selling Shareholders and their respective group companies, affiliates or associates or third parties in the ordinary course of business and have engaged, or may in the future engage, in commercial banking and investment banking transactions with or become customers to our Company, the Selling Shareholders and their respective group companies, affiliates or associates or third parties, for which they have received, and may in the future receive, compensation.

Bidders are advised to ensure that any Bid from them does not exceed the investment limits or maximum number of Equity Shares that can be held by them under applicable law.

Disclaimer in respect of Jurisdiction

The Offer is being made in India to persons resident in India (who are competent to contract under the Indian Contract Act, 1872, as amended, including Indian nationals resident in India, HUFs, companies, other corporate bodies and societies registered under the applicable laws in India and authorised to invest in shares, Indian Mutual Funds registered with SEBI, Indian financial institutions, commercial banks, regional rural banks, co-operative banks (subject to RBI permission), or trusts under applicable trust law and who are authorised under their respective constitution to hold and invest in equity shares, multilateral and bilateral development financial institutions, state industrial development corporations, insurance companies registered with IRDAI, provident funds (subject to applicable law) and pension funds, National Investment Fund, insurance funds set up and managed by army, navy or air force of Union of India, insurance funds set up and managed by the Department of Posts, GoI, systemically important NBFCs registered with the RBI) and permitted Non-Residents including FPIs and Eligible NRIs, AIFs and other eligible foreign investors, if any, provided that they are eligible under all applicable laws and regulations to purchase the Equity Shares. This Red Herring Prospectus does not constitute an offer to sell or an invitation to subscribe to Equity Shares offered hereby, in any jurisdiction other than in India to any person to whom it is unlawful to make an offer or invitation in such jurisdiction. Any person into whose possession this Red Herring Prospectus comes is required to inform himself or herself about, and to observe, any such restrictions. The Draft Red Herring Prospectus did not constitute an invitation to subscribe to or purchase the Equity Shares in the Offer in any jurisdiction, including India. Invitations to subscribe to or purchase the Equity Shares in the Offer will be made only pursuant to this Red Herring Prospectus if the recipient is in India or the preliminary offering memorandum for the Offer, which comprises this Red Herring Prospectus and the preliminary international wrap for the Offer, if the recipient is outside India. No person outside India is eligible to bid for Equity Shares in the Offer unless that person has received the preliminary offering memorandum for the Offer, which contains the selling restrictions for the Offer outside India. Any dispute arising out of the Offer will be subject to the jurisdiction of appropriate court(s) in Mumbai only.

No action has been, or will be, taken to permit a public offering in any jurisdiction where action would be required for that purpose, except that the Draft Red Herring Prospectus was filed with SEBI for its observations. Accordingly, the Equity Shares represented hereby may not be offered or sold, directly or indirectly, and this Red Herring Prospectus may not be distributed, in any jurisdiction, except in accordance with the legal requirements applicable in such jurisdiction. Neither the delivery of this Red Herring Prospectus nor any offer or sale hereunder shall, under any circumstances, create any implication that there has been no change in the affairs of our Company or the Selling Shareholders since the date hereof or that the information contained herein is correct as of any time subsequent to this date.

Eligibility and Transfer Restrictions

The Equity Shares offered in the Offer have not been, and will not be, registered under the U.S. Securities Act and may not be offered or sold within the United States, except pursuant to an exemption from, or in a transaction not subject to, the registration requirements of the U.S. Securities Act and accordingly, the Equity Shares are being offered and sold (i) within the United States solely to persons who are reasonably believed to be “qualified institutional buyers” (as defined in Rule 144A under the U.S. Securities Act) in transactions exempt from the registration requirements of the U.S. Securities Act, and (ii) outside the United States in “offshore transactions” as defined in and in reliance on Regulation S under the U.S. Securities Act and the applicable laws of the jurisdiction where those offers and sales occur.

The Equity Shares have not been and will not be registered, listed or otherwise qualified in any other jurisdiction outside India and may not be issued or sold, and Bids may not be made by persons in any such jurisdiction, except in compliance with the applicable laws of such jurisdiction.

Bidders are advised to ensure that any Bid from them does not exceed investment limits or maximum number of Equity Shares that can be held by them under applicable law.

Disclaimer Clause of BSE

As required, a copy of the Draft Red Herring Prospectus has been submitted to BSE. The disclaimer clause as intimated by BSE to our Company, post scrutiny of the Draft Red Herring Prospectus, is as set forth below:

BSE Limited ("**the Exchange**") has given vide its letter dated June 09, 2023, permission to this Company to use the Exchange's name in this offer document as one of the stock exchanges on which this company's securities are proposed to be listed. The Exchange has scrutinized this offer document for its limited internal purpose of deciding on the matter of granting the aforesaid permission to this Company. The Exchange does not in any manner:-

- a) warrant, certify or endorse the correctness or completeness of any of the contents of this offer document; or
- b) warrant that this Company's securities will be listed or will continue to be listed on the Exchange; or
- c) take any responsibility for the financial or other soundness of this Company, its promoters, its management or any scheme or project of this Company

and it should not for any reason be deemed or construed that this offer document has been cleared or approved by the Exchange. Every person who desires to apply for or otherwise acquires any securities of this Company may do so pursuant to independent inquiry, investigation and analysis and shall not have any claim against the Exchange whatsoever by reason of any loss which may be suffered by such person consequent to or in connection with such subscription/acquisition whether by reason of anything stated or omitted to be stated herein or for any other reason whatsoever.

Disclaimer Clause of NSE

As required, a copy of the Draft Red Herring Prospectus has been submitted to NSE. The disclaimer clause as intimated by NSE to our Company, is as set forth below.

As required, a copy of this Offer Document has been submitted to National Stock Exchange of India Limited (hereinafter referred to as NSE). NSE has given vide its letter Ref.: NSE/LIST/2347 dated June 09, 2023, permission to the Issuer to use the Exchange's name in this Offer Document as one of the Stock Exchanges on which this Issuer's securities are proposed to be listed. The Exchange has scrutinized this draft offer document for its limited internal purpose of deciding on the matter of granting the aforesaid permission to this Issuer. It is to be distinctly understood that the aforesaid permission given by NSE should not in any way be deemed or construed that the offer document has been cleared or approved by NSE; nor does it in any manner warrant, certify or endorse the correctness or completeness of any of the contents of this offer document; nor does it warrant that this Issuer's securities will be listed or will continue to be listed on the Exchange; nor does it take any responsibility for the financial or other soundness of this Issuer, its promoters, its management or any scheme or project of this Issuer. Every person who desires to apply for or otherwise acquire any securities of this Issuer may do so pursuant to independent inquiry, investigation and analysis and shall not have any claim against the Exchange whatsoever by reason of any loss which may be suffered by such person consequent to or in connection with such subscription /acquisition whether by reason of anything stated or omitted to be stated herein or any other reason whatsoever.

Listing

The Equity Shares issued through this Red Herring Prospectus are proposed to be listed on BSE and NSE. Applications will be made to the Stock Exchanges for permission to deal in and for an official quotation of the Equity Shares. BSE will be the Designated Stock Exchange with which the Basis of Allotment will be finalised.

If the permission to deal in and for an official quotation of the Equity Shares is not granted by the Stock Exchanges, our Company shall forthwith repay, without interest, all monies received from the applicants in pursuance of this Red Herring Prospectus in accordance with applicable law. Our Company shall ensure that all steps for the completion of the necessary formalities for listing and commencement of trading of Equity Shares at the Stock Exchanges are taken within such time prescribed by SEBI. If our Company does not allot Equity Shares pursuant to the Offer within such timeline as prescribed by SEBI, it shall repay without interest all monies received from Bidders, failing which interest shall be due to be paid to the Bidders at the rate of 15% per annum for the delayed period or such other rate prescribed by SEBI.

The Selling Shareholders undertake to provide such reasonable assistance as may be requested by our Company, to the extent such assistance is required from the Selling Shareholders in relation to their respective portion of the Offered Shares to facilitate the process of listing and commencement of trading of the Equity Shares on the Stock Exchanges within such time prescribed by SEBI.

Consents

Consents in writing of (a) each of the Selling Shareholders, our Directors, our Company Secretary and Compliance Officer, legal counsels appointed for the Offer, the Book Running Lead Managers, the bankers to our Company, Technopak, Statutory Auditors, Independent Chartered Accountant, Independent Chartered Engineer and the Registrar to the Offer to act in their respective capacities, have been obtained and (b) Syndicate Members, Bankers to the Offer (Escrow Collection Bank, Public Offer Bank, Sponsor Banks and Refund Bank) to act in their respective capacities, Monitoring Agency will be obtained, and will be filed along with a copy of this Red Herring Prospectus with the RoC as required under the Companies Act and such consents have not been and shall not be withdrawn up to the time of delivery of this Red Herring Prospectus and the Prospectus for filing with the RoC.

Experts to the Offer

Except as disclosed below, our Company has not obtained any expert opinions in connection with this Red Herring Prospectus:

Our Company has received a written consent dated September 6, 2023, from our Statutory Auditor, namely, B S R & Co. LLP, Chartered Accountants, who hold a valid peer review certificate from ICAI, to include their name as required under section 26(5) of the Companies Act, 2013 read with SEBI ICDR Regulations, in this RHP, and as an “expert” as defined under section 2(38) of the Companies Act, 2013 to the extent and in their capacity as our Statutory Auditor, and in respect of their (a) examination report dated August 30, 2023, on the Restated Consolidated Financial Information, and (b) report dated September 6, 2023 on the statement of special tax benefits. Such consent has not been withdrawn as on the date of this RHP. However, the term “expert” and “consent” shall not be construed to mean an “expert” and “consent” as defined under the U.S. Securities Act.

Our Company has received written consent dated August 28, 2023, from Vishvakarma Consultancy Services Private Limited, Chartered Engineer, to include their name as required under Section 26(5) of the Companies Act read with SEBI ICDR Regulations, in this Red Herring Prospectus and as an “expert”, as defined under Section 2(38) of the Companies Act, 2013 to the extent and in their capacity as an Independent Chartered Engineer, in relation to the certificate dated August 28, 2023 certifying, *inter alia*, the details of the installed and production capacity of our manufacturing facilities.

Particulars regarding public or rights issues by our Company during the last five years and performance *vis-à-vis* objects

Our Company has not made any public or rights issues (as defined under the SEBI ICDR Regulations) during the five years preceding the date of this Red Herring Prospectus.

Performance *vis-à-vis* objects – Last issue of subsidiaries and promoters

As on date of this Red Herring Prospectus, our Company does not have a corporate promoter or a subsidiary.

Underwriting Commission, Brokerage and Selling Commission paid on previous issues of the Equity Shares

Since this is the initial public offer of Equity Shares, no sum has been paid or is payable as commission or brokerage for subscribing to or procuring or agreeing to procure subscription for any of the Equity Shares in the five years preceding the date of this Red Herring Prospectus.

Capital issue during the previous three years by listed subsidiaries or associates of our Company

Our Company does not have any subsidiaries or listed associates, as on the date of this Red Herring Prospectus.

Capital issue during the previous three years by listed group companies of our Company

Except as disclosed below, our listed Group Company, Ram Ratna Wires Limited, has not made any capital issues during the three years preceding the date of this Red Herring Prospectus:

Particulars	Information
Year of issue	2022
Type of issue	Bonus issue
Amount of issue (in ₹)	₹ 110 million
Issue price (in ₹)	Not applicable
Current market price as on September 5, 2023 (in ₹)	307.75
Date of closure of issue	Not applicable
Date of allotment and credit of securities to dematerialized account of investors	Allotment date: October 1, 2022 Date of credit of securities to dematerialized account of investors: October 7, 2022
Date of completion of the project, where the object of the issue was financing the project	Not applicable
Rate of dividend paid	Nil

Capital issue during the preceding three years by our Company

Other than as disclosed in “*Capital Structure – Notes to the Capital Structure- Equity Share capital history of our Company*” on page 82, our Company has not made any capital issues during the three years preceding the date of this Red Herring Prospectus.

Price information of past issues handled by the Book Running Lead Managers (during the current Financial Year and two Financial Years preceding the current Financial Year)

A. Axis Capital Limited

1. Price information of past issues (during the current Financial Year and two Financial Years preceding the current Financial Year) handled by Axis Capital Limited:

Sl. No.	Issue Name	Issue Size (in ₹ million)	Issue Price (₹)	Listing Date	Opening Price on Listing Date (₹)	+/- % change in closing price*, [+/- % change in closing benchmark]- 30 th calendar days from listing	+/- % change in closing price*, [+/- % change in closing benchmark]- 90 th calendar days from listing	+/- % change in closing price*, [+/- % change in closing benchmark]- 180 th calendar days from listing
1.	TVS Supply Chain Solutions Limited ⁽²⁾	8,800.00	197.00	23-Aug-23	207.05	-	-	-
2.	SBFC Finance Limited ⁽²⁾	10,250.00	57.00	16-Aug-23	82.00	-	-	-
3.	Cyient DLM Limited ^{& (2)}	5,920.00	265.00	10-Jul-23	403.00	+86.79%, [+1.11%]	-	-
4.	Mankind Pharma Limited ⁽²⁾	43,263.55	1,080.00	09-May-23	1,300.00	+37.61%, [+2.52%]	+74.13%, [+6.85%]	-
5.	Elin Electronics Limited ⁽¹⁾	4,750.00	247.00	30-Dec-22	243.00	-15.55%, [-2.48%]	-52.06%, [-4.73%]	-29.35%, [+4.23%]
6.	Landmark Cars Limited ^{* (1)}	5,520.00	506.00	23-Dec-22	471.30	+22.83%, [+1.30%]	+1.16%, [-2.72%]	+35.06%, [+5.82%]
7.	Uniparts India Limited ⁽¹⁾	8,356.08	577.00	12-Dec-22	575.00	-5.11%, [-3.24%]	-7.38%, [-4.82%]	-0.60%, [+0.80%]
8.	Keystone Realtors Limited ⁽¹⁾	6,350.00	541.00	24-Nov-22	555.00	-12.26%, [-3.90%]	-9.70%, [-2.57%]	-8.64%, [-0.50%]
9.	Bikaji Foods International Limited ^{# (1)}	8,808.45	300.00	16-Nov-22	321.15	+28.65%, [-0.29%]	+26.95%, [-2.50%]	+24.17%, [+0.08%]
10.	DCX Systems Limited ⁽¹⁾	5,000.00	207.00	11-Nov-22	286.25	+17.10%, [+0.63%]	-12.56%, [-1.83%]	-12.32%, [-0.05%]

Source: www.nseindia.com and www.bseindia.com

⁽¹⁾BSE as Designated Stock Exchange

⁽²⁾NSE as Designated Stock Exchange

¹ Offer Price was ₹ 55.00 per equity share to Eligible Employees

[&] Offer Price was ₹ 250.00 per equity share to Eligible Employees

^{*} Offer Price was ₹ 458.00 per equity share to Eligible Employees

[#] Offer Price was ₹ 285.00 per equity share to Eligible Employees

Notes:

a. Issue Size derived from Prospectus/final post issue reports, as available.

b. The CNX NIFTY or S&P BSE SENSEX is considered as the Benchmark Index as per the Designated Stock Exchange disclosed by the respective Issuer at the time of the issue, as applicable.

c. Price on NSE or BSE is considered for all of the above calculations as per the Designated Stock Exchange disclosed by the respective Issuer at the time of the issue, as applicable.

d. In case 30th/90th/180th day is not a trading day, closing price of the previous trading day has been considered.

e. Since 30 calendar days, 90 calendar days and 180 calendar days, as applicable, from listing date has not elapsed for few of the above issues, data for same is not available.

2. *Summary statement of price information of past issues handled by Axis Capital Limited*

Financial Year	Total No. of IPO's	Total Funds Raised (in ₹ million)	No. of IPOs trading at discount – 30 th calendar days from listing			No. of IPOs trading at premium – 30 th calendar days from listing			No. of IPOs trading at discount – 180 th calendar days from listing			No. of IPOs trading at premium – 180 th calendar days from listing		
			Over 50%	Between 25-50%	Less than 25%	Over 50%	Between 25-50%	Less than 25%	Over 50%	Between 25-50%	Less than 25%	Over 50%	Between 25-50%	Less than 25%
2023-2024*	4	68,233.55	-	-	-	1	1	-	-	-	-	-	-	-
2022-2023	11	279,285.39	-	1	6	-	2	2	-	2	5	-	3	1
2021-2022	25	609,514.77	-	2	6	6	5	6	3	4	3	5	3	7

* The information is as on the date of the document

The information for each of the financial years is based on issues listed during such financial year.

Note: Since 30 calendar days and 180 calendar days, as applicable, from listing date has not elapsed for few of the above issues, data for same is not available.

B. Citigroup Global Markets India Private Limited

1. Price information of past issues (during the current Financial Year and two Financial Years preceding the current Financial Year) handled by Citigroup Global Markets India Private Limited.

S. No	Issue Name	Issue Size (₹ million)	Issue Price (₹)	Listing Date	Opening Price on listing date (in ₹)	+/- % change in closing price, [+/- % change in closing benchmark]- 30 th calendar days from listing	+/- % change in closing price, [+/- % change in closing benchmark]- 90 th calendar days from listing	+/- % change in closing price, [+/- % change in closing benchmark]- 180 th calendar days from listing
1	Concord Biotech Limited	15,505.21	741.00	August 18, 2023	900.05	NA	NA	NA
2	Delhivery Limited	52,350.0	487.00	May 24, 2022	495.20	+3.49% [-4.41%]	+17.00% [10.13%]	-27.99% [13.53%]
3	Life Insurance Corporation of India	205,572.3	949.00	May 17, 2022	872.00	-27.28% [-3.49%]	-28.09% [8.85%]	-33.86% [12.86%]
4	Star Health and Allied Insurance Company Limited	64,004.39	900.00	December 10, 2021	845.00	-14.78% [+1.96%]	-29.79% [-6.66%]	-22.21% [-6.25%]
5	One 97 Communications Limited	183,000.00	2,150.00	November 18, 2021	1,955.00	-38.56% [-4.17%]	-60.40% [-2.32%]	-72.49% [-10.82%]
6	PB Fintech Limited	57,097.15	980.00	November 15, 2021	1,150.00	14.86% [-4.17%]	-20.52% [-4.06%]	-33.86% [-12.85%]
7	FSN E-Commerce Ventures Limited	53,497.24	1,125.00	November 10, 2021	2,018.00	92.31% [-2.53%]	68.46% [-4.46%]	36.80% [-8.91%]
8	Aditya Birla Sun Life AMC Limited	27,682.56	712.00	October 11, 2021	715.00	-11.4% [-0.98%]	-23.85% [-0.51%]	-25.65% [-0.90%]
9	Aptus Value Housing Finance India Limited	27,800.52	353.00	August 24, 2021	333.00	-2.82% [+5.55%]	-0.82% [+7.38%]	+0.62% [+6.86%]
10	Cartrade Tech Limited	29,985.13	1,618.00	August 20, 2021	1,599.80	-10.31% [+6.90%]	-32.68% [+9.24%]	-61.17% [+8.80%]

Source: www.nseindia.com

Notes:

1. Nifty is considered as the benchmark index.

2. % of change in closing price on 30th / 90th / 180th calendar day from listing day is calculated vs. Issue Price. % change in closing benchmark index is calculated based on closing index on listing day vs. closing index on 30th / 90th / 180th calendar day from listing day.

3. 30th, 90th, 180th calendar day from listed day have been taken as listing day plus 29, 89 and 179 calendar days, except wherever 30th, 90th, 180th calendar day is a holiday, in which case closing price on NSE of a trading day immediately prior to the 30th / 90th / 180th day, is considered.

2. *Summary statement of price information of past issues handled by Citigroup Global Markets India Private Limited.*

Financial Year	Total no. of IPOs	Total amount of funds raised (₹ mn)	No. of IPOs trading at discount – 30 th calendar days from listing			No. of IPOs trading at premium – 30 th calendar days from listing			No. of IPOs trading at discount – 180 th calendar days from listing			No. of IPOs trading at premium – 180 th calendar days from listing		
			Over 50%	Between 25-50%	Less than 25%	Over 50%	Between 25-50%	Less than 25%	Over 50%	Between 25-50%	Less than 25%	Over 50%	Between 25-50%	Less than 25%
2023-24	1	15,505.21	-	-	-	-	-	-	-	-	-	-	-	-
2022-23	2	257,922.30	-	1	-	-	-	1	-	2	-	-	-	-
2021-22	8	5,36,816.99	-	1	4	2	-	1	2	2	1	1	1	1

Source: www.nseindia.com

Notes:

- (1) The information is as on the date of the document.
- (2) The information for each of the financial years is based on issues listed during such financial year.
- (3) Since 30 calendar days and 180 calendar days, as applicable, from listing date has not elapsed for few of the above issues, data for same is not available.

C. HSBC Securities and Capital Markets (India) Private Limited

1. Price information of past issues (during the current Financial Year and two Financial Years preceding the current Financial Year) handled by HSBC Securities and Capital Markets (India) Private Limited

S. No.	Issue Name	Issue Size (₹ million)	Issue price (₹)	Listing Date	Opening Price on Listing Date (in ₹)	+/- % change in closing price, [+/- % change in closing benchmark]- 30 th calendar days from listing	+/- % change in closing price, [+/- % change in closing benchmark]- 90 th calendar days from listing	+/- % change in closing price, [+/- % change in closing benchmark]- 180 th calendar days from listing
1.	Nuvoco Vistas Corporation Limited (IPO)	50,000.00	570.00	August 23, 2021	471.00	-5.83%, [+6.21%]	-9.74%, [+7.34%]	-32.76%, [+4.10%]

Source: www.nseindia.com for price information and prospectus/basis of allotment for issue details

Notes:

1. Issue Size derived from Prospectus/final post issue reports, as available.
2. Nifty Index and Sensex is considered as the Benchmark Index as per the designated stock exchange (NSE or BSE)
3. Price on designated stock exchange (NSE or BSE) as disclosed by the respective issuer at the time of issue has been considered for all of the above calculations.
4. In case 30th/90th/180th day is not a trading day, closing price on designated stock exchange (NSE or BSE) of the previous trading day has been considered.
5. Since 30 calendar days, 90 calendar days and 180 calendar days, as applicable, from listing date has not elapsed for few of the above issues, data for same is not applicable

2. *Summary statement of price information of past issues handled by HSBC Securities and Capital Markets (India) Private Limited*

Fiscal Year*	Total no. of IPOs	Total amount of funds raised (₹ Mn.)	No. of IPOs trading at discount - 30 th calendar days from listing			No. of IPOs trading at premium - 30 th calendar days from listing			No. of IPOs trading at discount - 180 th calendar days from listing			No. of IPOs trading at premium - 180 th calendar days from listing		
			Over 50%	Between 25-50%	Less than 25%	Over 50%	Between 25-50%	Less than 25%	Over 50%	Between 25-50%	Less than 25%	Over 50%	Between 25-50%	Less than 25%
2023-24	-	-	-	-	-	-	-	-	-	-	-	-	-	-
2022-23	-	-	-	-	-	-	-	-	-	-	-	-	-	-
2021-22	1	50,000.00	-	-	1	-	-	-	-	1	-	-	-	-

The information for each of the period is based on issues listed during such period.

D. JM Financial Limited

1. Price information of past issues (during the current Financial Year and two Financial Years preceding the current Financial Year) handled by JM Financial Limited

Sr. No.	Issue name	Issue Size (₹ million)	Issue price (₹)	Listing Date	Opening price on Listing Date (in ₹)	+/- % change in closing price, [+/- % change in closing benchmark] - 30th calendar days from listing	+/- % change in closing price, [+/- % change in closing benchmark] - 90th calendar days from listing	+/- % change in closing price, [+/- % change in closing benchmark] - 180th calendar days from listing
1.	TVS Supply Chain Solutions Limited*	8,800.00	197.00	August 23, 2023	207.50	Not Applicable	Not Applicable	Not Applicable
2.	Cyient DLM Limited*	5,920.00	265.00	July 10, 2023	403.00	86.79% [1.11%]	Not Applicable	Not Applicable
3.	Ideaforge Technology Limited*	5,672.45	672.00	July 7, 2023	1,300.00	64.59% [0.96%]	Not Applicable	Not Applicable
4.	Avalon Technologies Limited*	8,650.00	436.00	April 18, 2023	436.00	-10.09% [2.95%]	59.45% [10.78%]	Not Applicable
5.	Elin Electronics Limited#	4,750.00	247.00	December 30, 2022	243.00	-15.55% [-2.48%]	-52.06% [-4.73%]	-29.35% [4.23%]
6.	Uniparts India Limited#	8,356.08	577.00	December 12, 2022	575.00	-5.11% [-3.24%]	-7.38% [-4.82%]	-0.60% [0.80%]
7.	Archean Chemical Industries Limited*	14,623.05	407.00	November 21, 2022	450.00	25.42% [1.24%]	56.87% [-1.19%]	32.68% [0.24%]
8.	Bikaji Foods International Limited#7	8,808.45	300.00	November 16, 2022	321.15	28.65% [-0.29%]	26.95% [-2.50%]	24.23% [0.08%]
9.	Global Health Limited*	22,055.70	336.00	November 16, 2022	401.00	33.23% [0.03%]	35.94% [-3.47%]	61.67% [-0.52%]
10.	Fusion Micro Finance Limited*	11,039.93	368.00	November 15, 2022	359.50	9.86% [1.40%]	12.84% [-2.97%]	25.52% [-0.48%]

Source: www.nseindia.com and www.bseindia.com

BSE as Designated Stock Exchange

* NSE as Designated Stock Exchange

Notes:

- Opening price information as disclosed on the website of the Designated Stock Exchange.
- Change in closing price over the issue/offer price as disclosed on Designated Stock Exchange.
- For change in closing price over the closing price as on the listing date, the CNX NIFTY or S&P BSE SENSEX is considered as the Benchmark Index as per the Designated Stock Exchange disclosed by the respective Issuer at the time of the issue, as applicable.
- In case of reporting dates falling on a trading holiday, values for the trading day immediately preceding the trading holiday have been considered.
- 30th calendar day has been taken as listing date plus 29 calendar days; 90th calendar day has been taken as listing date plus 89 calendar days; 180th calendar day has been taken as listing date plus 179 calendar days.
- Restricted to last 10 issues.
- A discount of Rs. 15 per Equity Share was offered to Eligible Employees bidding in the Employee Reservation Portion.
- Not Applicable – Period not completed.

2. *Summary statement of price information of past issues handled by JM Financial Limited*

Financial Year	Total No. of IPO's	Total Funds Raised (in ₹ million)	No. of IPOs trading at discount – 30 th calendar days from listing			No. of IPOs trading at premium – 30 th calendar days from listing			No. of IPOs trading at discount – 180 th calendar days from listing			No. of IPOs trading at premium – 180 th calendar days from listing		
			Over 50%	Between 25-50%	Less than 25%	Over 50%	Between 25-50%	Less than 25%	Over 50%	Between 25-50%	Less than 25%	Over 50%	Between 25-50%	Less than 25%
2023-2024	4	29,042.45	-	-	1	2	-	-	-	-	-	-	-	-
2022-2023	11	3,16,770.53	-	1	3	-	5	2	-	1	1	1	1	1
2021-2022	17	2,89,814.06	-	1	2	5	5	4	1	2	3	4	3	4

Source: www.nseindia.com; www.bseindia.com, as applicable

Track record of past issues handled by the Book Running Lead Managers

For details regarding the track record of the Book Running Lead Managers, as specified in circular bearing number CIR/MIRSD/1/2012 dated January 10, 2012 issued by SEBI, please see the websites of the Book Running Lead Managers, as provided in the table below:

S. No.	Name of the Book Running Lead Managers	Website
1.	Axis Capital Limited	www.axiscapital.co.in
2.	Citigroup Global Markets India Private Limited	www.online.citibank.co.in
3.	HSBC Securities and Capital Markets (India) Private Limited	www.business.hsbc.co.in
4.	JM Financial Limited	www.jmfl.com

Stock Market Data of Equity Shares

This being an initial public issue of the Equity Shares of our Company, the Equity Shares are not listed on any stock exchange as on the date of this Red Herring Prospectus and accordingly, no stock market data is available for the Equity Shares.

Redressal and disposal of investor grievances by our Company

The Registrar Agreement provides for retention of records with the Registrar to the Offer for a period of at least eight years from the date of listing and commencement of trading of the Equity Shares to enable the Bidders to approach the Registrar to the Offer for redressal of their grievances. The Registrar to the Offer shall obtain the required information from the SCSBs for addressing any clarifications or grievances of ASBA Bidders.

All grievances, other than of Anchor Investors may be addressed to the Registrar to the Offer with a copy to the relevant Designated Intermediary with whom the ASBA Form was submitted, giving full details such as name of the sole or First Bidder, ASBA Form number, Bidder's DP ID, Client ID, PAN, address of Bidder, number of Equity Shares applied for, ASBA Account number in which the amount equivalent to the Bid Amount was blocked or the UPI ID (for UPI Bidders who make the payment of Bid Amount through the UPI Mechanism), date of ASBA Form and the name and address of the relevant Designated Intermediary where the Bid was submitted. Further, the Bidder shall enclose the Acknowledgment Slip or the application number from the Designated Intermediary in addition to the documents or information mentioned hereinabove. All grievances relating to Bids submitted through Registered Brokers may be addressed to the Stock Exchanges with a copy to the Registrar to the Offer.

All grievances of the Anchor Investors may be addressed to the Registrar to the Offer, giving full details such as the name of the sole or First Bidder, Bid cum Application Form number, Bidders' DP ID, Client ID, PAN, date of the Bid cum Application Form, address of the Bidder, number of the Equity Shares applied for, Bid Amount paid on submission of the Bid cum Application Form and the name and address of the Book Running Lead Managers where the Bid cum Application Form was submitted by the Anchor Investor.

In case of any delay in unblocking of amounts in the ASBA Accounts exceeding four Working Days from the Bid / Offer Closing Date, the Bidder shall be compensated at a uniform rate of ₹ 100 per day or 15% per annum of the Bid Amount, whichever is higher, for the entire duration of delay exceeding four Working Days from the Bid / Offer Closing Date by the intermediary responsible for causing such delay in unblocking. The BRLMs shall, in their sole discretion, identify and fix the liability on such intermediary or entity responsible for such delay in unblocking.

In terms of SEBI circular SEBI/HO/CFD/DIL2/CIR/P/2018/22 dated February 15, 2018, SEBI circular SEBI/HO/CFD/DIL2/CIR/P/2021/2480/1/M dated March 16, 2021, as amended pursuant to SEBI circular SEBI/HO/CFD/DIL2/P/CIR/2021/570 dated June 2, 2021 and SEBI circular no. SEBI/HO/CFD/DIL2/CIR/P/2022/51 dated April 20, 2022 and subject to applicable law, any ASBA Bidder whose Bid has not been considered for Allotment, due to failure on the part of any SCSB, shall have the option to seek redressal of the same by the concerned SCSB within three months of the date of listing of the Equity Shares. SCSBs are required to resolve these complaints within 15 days, failing which the concerned SCSB would have to pay interest at the rate of 15% per annum for any delay beyond this period of 15 days. The following compensation mechanism has become applicable for investor grievances in relation to Bids made through the UPI Mechanism for public issues opening on or after May 1, 2021, for which the relevant SCSBs shall be liable to compensate the investor:

Scenario	Compensation amount	Compensation period
Delayed unblock for cancelled / withdrawn / deleted applications	₹100 per day or 15% per annum of the Bid Amount, whichever is higher	From the date on which the request for cancellation / withdrawal / deletion is placed on the bidding platform of the Stock Exchanges till the date of actual unblock
Blocking of multiple amounts for the same Bid made through the UPI Mechanism	1. Instantly revoke the blocked funds other than the original application amount and 2. ₹100 per day or 15% per annum of the total cumulative blocked amount except the original Bid Amount, whichever is higher	From the date on which multiple amounts were blocked till the date of actual unblock

Scenario	Compensation amount	Compensation period
Blocking more amount than the Bid Amount	1. Instantly revoke the difference amount, i.e., the blocked amount less the Bid Amount and 2. ₹100 per day or 15% per annum of the difference amount, whichever is higher	From the date on which the funds to the excess of the Bid Amount were blocked till the date of actual unblock
Delayed unblock for non – Allotted / partially Allotted applications	₹100 per day or 15% per annum of the Bid Amount, whichever is higher	From the Working Day subsequent to the finalisation of the Basis of Allotment till the date of actual unblock

Further, in the event there are any delays in resolving the investor grievance beyond the date of receipt of the complaint from the investor, for each day delayed, the Book Running Lead Managers shall be liable to compensate the investor ₹ 100 per day or 15% per annum of the Bid Amount, whichever is higher. The compensation shall be payable for the period ranging from the day on which the investor grievance is received till the date of actual unblock. Further, in accordance with circulars prescribed by SEBI, from time to time, the payment of processing fees to the SCSBs shall be undertaken pursuant to an application made by the SCSBs to the BRLMs, and such application shall be made only after (i) unblocking of application amounts for each application received by the SCSB has been fully completed, and (ii) applicable compensation relating to investor complaints has been paid by the SCSB.

Our Company, the Selling Shareholders, the BRLMs and the Registrar to the Offer accept no responsibility for errors, omissions, commission or any acts of SCSBs including any defaults in complying with its obligations under applicable SEBI ICDR Regulations. In terms of SEBI circular no. SEBI/HO/CFD/DIL2/CIR/P/2018/22, dated February 15, 2018 and SEBI master circular no. SEBI/HO/CFD/PoD-2/P/CIR/2023/00094 dated June 21, 2023, any ASBA Bidder whose Bid has not been considered for Allotment, due to failure on the part of any SCSB, shall have the option to seek redressal of the same by the concerned SCSB within three months of the date of listing of the Equity Shares. SCSBs are required to resolve these complaints within 15 days, failing which the concerned SCSB would have to pay interest at the rate of 15% per annum for any delay beyond this period of 15 days.

For helpline details of the Book Running Lead Managers pursuant to the SEBI/HO/CFD/DIL-2/OW/P/2021/2481/1/M dated March 16, 2021, see “*General Information – Book Running Lead Managers*” on page 74.

Further, the Bidder shall also enclose a copy of the Acknowledgment Slip duly received from the concerned Designated Intermediary in addition to the information mentioned hereinabove.

The Registrar to the Offer shall obtain the required information from the SCSBs and Sponsor Banks for addressing any clarifications or grievances of ASBA Bidders. Our Company, the Book Running Lead Managers and the Registrar to the Offer accept no responsibility for errors, omissions, commission or any acts of SCSBs including any defaults in complying with its obligations under the SEBI ICDR Regulations. Bidders can contact our Company Secretary and Compliance officer or the Registrar to the Offer in case of any pre-Offer or post-Offer related problems such as non-receipt of letters of Allotment, non-credit of Allotted Equity Shares in the respective beneficiary account, non-receipt of refund intimations and non-receipt of funds by electronic mode.

Our Company has also appointed Himanshu Navinchandra Parmar, Company Secretary and Compliance officer for the Offer. For details, see “*General Information*” beginning on page 73.

Disposal of Investor Grievances by our Company

Our Company estimates that the average time required by our Company or the Registrar to the Offer or the relevant Designated Intermediary, for the redressal of routine investor grievances shall be 7 (seven) days from the date of receipt of the complaint. In case of non-routine complaints and complaints where external agencies are involved, our Company will seek to redress these complaints within 30 days of receipt of complaint or upon receipt of satisfactory documents.

Our Company has not received any investor complaint during the three years preceding the date of this Red Herring Prospectus. Further, no investor complaint in relation to our Company and our listed Group Company is pending as on the date of this Red Herring Prospectus.

Our Company has obtained authentication on the SCORES in terms of the SEBI circular bearing number CIR/OIAE/1/2013 dated April 17, 2013 read with SEBI circular bearing number SEBI/HO/OIAE/IGRD/CIR/P/2021/642 dated October 14, 2021 and shall comply with SEBI circular bearing number CIR/OIAE/1/2014 dated December 18, 2014 in relation to redressal of investor grievances through SCORES.

Our Company has constituted a Stakeholders’ Relationship Committee comprising Bhagwat Singh Babel (Independent Director) as Chairman, Ramesh Chandak (Independent Director) and Shreegopal Rameshwarlal Kabra (Managing Director) as its members which is responsible for redressal of grievances of security holders of our Company. For further details on the Stakeholders’ Relationship Committee, see “*Our Management – Committees of the Board – Stakeholders’ Relationship Committee*” on page 252.

Exemptions from complying with any provision of securities laws, if any, granted by the SEBI

Our Company has not sought an exemption from complying with any provisions of securities laws by the SEBI.

Other confirmations

Any person connected with the Offer shall not offer any incentive, whether direct or indirect, in any manner, whether in cash or kind or services or otherwise to any person for making an application in the initial public offer, except for fees or commission for services rendered in relation to the Offer.

SECTION VII: OFFER INFORMATION

TERMS OF THE OFFER

The Equity Shares being offered and allotted and transferred pursuant to this Offer shall be subject to the provisions of the Companies Act, SEBI ICDR Regulations, SEBI Listing Regulations, SCRA, SCRR, our Memorandum of Association and Articles of Association, the terms of this Red Herring Prospectus, the Prospectus, the Abridged Prospectus, the Bid cum Application Form, the Revision Form, the CAN or Allotment Advice and other terms and conditions as may be incorporated in the Allotment Advices and other documents or certificates that may be executed in respect of the Offer. The Equity Shares shall also be subject to laws as applicable, guidelines, rules, notifications and regulations relating to the issue of capital and listing and trading of securities issued from time to time by SEBI, the Government of India, the Stock Exchanges, the RBI, the RoC and/or other authorities, as in force on the date of the Offer and to the extent applicable or such other conditions as may be prescribed by SEBI, the RBI, the Government of India, the Stock Exchanges, the RoC and/or any other authorities while granting their approval for the Offer.

The Offer

The Offer comprises of a Fresh Issue and an Offer for Sale by the Selling Shareholders. Expenses for the Offer shall be shared amongst our Company and the Selling Shareholders in the manner specified in “*Objects of the Offer – Offer expenses*”, on page 116.

Ranking of Equity Shares

The Equity Shares being offered/Allotted and transferred pursuant to the Offer shall be subject to the provisions of the Companies Act, our Memorandum of Association and Articles of Association and shall rank *pari passu* in all respects with the existing Equity Shares including in respect of the right to receive dividend, voting and other corporate benefits. For further details, see “*Main Provisions of Articles of Association*” beginning on page 454.

Mode of Payment of Dividend

Our Company shall pay dividends, if declared, to the Shareholders in accordance with the provisions of the Companies Act, our Articles of Association and provisions of the SEBI Listing Regulations and any other guidelines or directions which may be issued by the Government in this regard. Dividends, if any, declared by our Company after the date of Allotment (pursuant to the transfer of Equity Shares from the Offer for Sale), will be payable to the Bidders who have been Allotted Equity Shares in the Offer, for the entire year, in accordance with applicable laws. For further details in relation to dividends, see “*Dividend Policy*” and “*Main Provisions of Articles of Association*” beginning on pages 268 and 454, respectively.

Face Value, Offer Price and Price Band

The face value of each Equity Share is ₹5 and the Offer Price is ₹[●] per Equity Share. The Floor Price is ₹[●] per Equity Share and at the Cap Price is ₹[●] per Equity Share, being the Price Band. The Anchor Investor Offer Price is ₹[●] per Equity Share.

The Price Band and the minimum Bid Lot will be decided by our Company and the Investor Selling Shareholder in consultation with the Book Running Lead Managers and advertised in all editions of the English national daily newspaper, The Financial Express, all editions of the Hindi national daily newspaper, Jansatta and the Mumbai edition of the Marathi daily newspaper, Navshakti (Marathi being the regional language of Maharashtra, where our Registered Office is located) each with wide circulation, at least two Working Days prior to the Bid/Offer Opening Date and shall be made available to the Stock Exchanges for the purpose of uploading the same on their websites. The Price Band, along with the relevant financial ratios calculated at the Floor Price and at the Cap Price, shall be pre-filled in the Bid cum Application Forms available on the websites of the Stock Exchanges. The Offer Price and discount (if any) shall be determined by our Company and the Investor Selling Shareholder, in consultation with the Book Running Lead Managers, after the Bid/Offer Closing Date.

At any given point of time there shall be only one denomination of Equity Shares.

Compliance with disclosure and accounting norms

Our Company shall comply with all disclosure and accounting norms as specified by SEBI from time to time.

Rights of the Shareholders

Subject to applicable laws, rules, regulations and guidelines and our Articles of Association, our Shareholders shall have the following rights:

- Right to receive dividends, if declared;
- Right to attend general meetings and exercise voting rights, unless prohibited by law;

- Right to vote on a poll either in person or by proxy and “e-voting”, in accordance with the provisions of the Companies Act;
- Right to receive offers for rights shares and be allotted bonus shares, if announced;
- Right to receive surplus on liquidation, subject to any statutory and preferential claim being satisfied;
- Right of free transferability of Equity Shares, subject to applicable laws, rules and regulations; and
- Such other rights, as may be available to a shareholder of a listed public company under the Companies Act, the SEBI Listing Regulations and our Articles of Association.

For a detailed description of the main provisions of the Articles of Association of our Company relating to voting rights, dividend, forfeiture and lien, transfer, transmission, consolidation or sub-division, see “*Main Provisions of Articles of Association*” beginning on page 454.

Allotment only in Dematerialised Form

Pursuant to Section 29 of the Companies Act and the SEBI ICDR Regulations, the Equity Shares shall be Allotted only in dematerialised form. As per the SEBI ICDR Regulations, the trading of the Equity Shares shall only be in dematerialised form. In this context, two agreements have been signed amongst our Company, the respective Depositories and the Registrar to the Offer:

- Tripartite agreement dated April 27, 2023 amongst our Company, CDSL and Link Intime India Private Limited.
- Tripartite agreement dated April 28, 2023 between our Company, NSDL and Link Intime India Private Limited.

Market Lot and Trading Lot

Since trading of the Equity Shares is in dematerialised form, the tradable lot is one Equity Share. Allotment in the Offer will be only in electronic form in multiples of one Equity Share subject to a minimum Allotment of [●] Equity Shares. For further details, see “*Offer Procedure*” beginning on page 436.

Jurisdiction

The courts of Mumbai, Maharashtra, India will have exclusive jurisdiction in relation to this Offer.

Joint Holders

Subject to the provisions contained in our Articles of Association, where two or more persons are registered as the holders of the Equity Shares, they shall be entitled to hold the same as joint tenants with benefits of survivorship.

Nomination facility to Bidders

In accordance with Section 72 of the Companies Act read with the Companies (Share Capital and Debentures) Rules, 2014, as amended, the sole Bidder, or the first Bidder along with other joint Bidders, may nominate any one person in whom, in the event of the death of sole Bidder or in case of joint Bidders, death of all the Bidders, as the case may be, the Equity Shares Allotted, if any, shall vest. A person, being a nominee, entitled to the Equity Shares by reason of the death of the original holder(s), shall be entitled to the same advantages to which he or she would be entitled if he or she were the registered holder of the Equity Share(s). Where the nominee is a minor, the holder(s) may make a nomination to appoint, in the prescribed manner, any person to become entitled to Equity Share(s) in the event of his or her death during the minority. A nomination shall stand rescinded upon a sale, transfer or alienation of Equity Share(s) by the person nominating. A buyer will be entitled to make a fresh nomination in the manner prescribed. Fresh nomination can be made only on the prescribed form available on request at our Registered Office or to the registrar and transfer agents of our Company.

Any person who becomes a nominee by virtue of the provisions of Section 72 of the Companies Act shall upon the production of such evidence as may be required by our Board, elect either:

- a) to register himself or herself as the holder of the Equity Shares; or
- b) to make such transfer of the Equity Shares, as the deceased holder could have made.

Further, our Board may at any time give notice requiring any nominee to choose either to be registered himself or herself or to transfer the Equity Shares, and if the notice is not complied with within a period of 90 days, our Board may thereafter withhold payment of all dividends, bonuses or other monies payable in respect of the Equity Shares, until the requirements of the notice have been complied with.

Since the Allotment of Equity Shares in the Offer will be made only in dematerialised mode there is no need to make a separate nomination with our Company. Nominations registered with respective Depository Participant of the Bidder would prevail. If the Bidder wants to change their nomination, they are requested to inform their respective Depository Participant.

Option to receive Equity Shares in Dematerialized Form

Allotment of Equity Shares to successful Bidders will only be in the dematerialized form. Bidders will not have the option of Allotment of the Equity Shares in physical form. The Equity Shares on Allotment will be traded only in the dematerialized segment of the Stock Exchanges.

Withdrawal of the Offer

The Offer shall be withdrawn in the event that 90% of the Fresh Issue portion of the Offer is not subscribed. Our Company and the Investor Selling Shareholder, in consultation with the Book Running Lead Managers, reserve the right not to proceed with the Offer for Sale, in whole or in part thereof, after the Bid/Offer Opening Date but before the Allotment. In such an event, our Company would issue a public notice in the newspapers in which the pre-Offer advertisements were published, within two days of the Bid/Offer Closing Date or such other time as may be prescribed by SEBI, providing reasons for not proceeding with the Offer. The Book Running Lead Managers through the Registrar to the Offer, shall notify the SCSBs and the Sponsor Banks, in case of the UPI Bidders using the UPI Mechanism, to unblock the bank accounts of the ASBA Bidders and shall notify the Escrow Collection Bank to release the Bid Amounts to the Anchor Investors, within one Working Day from the date of receipt of such notification. Our Company shall also inform the same to the Stock Exchanges on which Equity Shares are proposed to be listed. The notice of the withdrawal will be issued in the same newspapers where the pre-Offer advertisements have appeared.

Notwithstanding the foregoing, the Offer is also subject to obtaining (i) the final listing and trading approvals of the Stock Exchanges, which our Company shall apply for after Allotment, and (ii) the final RoC approval of the Prospectus after it is filed with the RoC. If our Company and the Investor Selling Shareholder, in consultation with the Book Running Lead Managers, withdraw the Offer after the Bid/Offer Closing Date and thereafter determine that they will proceed with a public offering of the Equity Shares, our Company shall file a fresh draft red herring prospectus with SEBI and the Stock Exchanges.

Bid/Offer programme

An indicative timetable in respect of the Offer is set out below:

Event	Indicative Date
BID/OFFER OPENS ON	Wednesday, September 13, 2023 ⁽¹⁾
BID/OFFER CLOSSES ON	Friday, September 15, 2023 ⁽²⁾
Finalisation of Basis of Allotment with the Designated Stock Exchange	On or about Thursday, September 21, 2023
Initiation of refunds (if any, for Anchor Investors)/unblocking of funds from ASBA Account*	On or about Friday, September 22, 2023
Credit of Equity Shares to demat accounts of Allottees	On or about Monday, September 25, 2023
Commencement of trading of the Equity Shares on the Stock Exchanges	On or about Tuesday, September 26, 2023

1. Our Company and the Investor Selling Shareholder shall, in consultation with the Book Running Lead Managers, consider participation by Anchor Investors in accordance with the SEBI ICDR Regulations. The Anchor Investor Bid/Offer Period shall be one Working Day prior to the Bid/Offer Opening Date i.e. Tuesday, September 12, 2023.

2. UPI mandate end time and date shall be at 5.00 p.m. on Bid/Offer Closing Date.

* In case of any delay in unblocking of amounts in the ASBA Accounts (including amounts blocked through the UPI Mechanism) exceeding four Working Days from the Bid/Offer Closing Date, the Bidder shall be compensated in accordance with applicable law. Further, investors shall be entitled to compensation in the manner specified in the SEBI circular no. SEBI/HO/CFD/DIL1/CIR/P/2021/47 dated March 31, 2021, SEBI circular no. SEBI/HO/CFD/DIL2/P/CIR/2021/570 dated June 2, 2021, SEBI circular no. SEBI/HO/CFD/DIL2/CIR/P/2022/51 dated April 20, 2022 and SEBI master circular no. SEBI/HO/CFD/PoD-2/P/CIR/2023/00094 dated June 21, 2023, in case of delays in resolving investor grievances in relation to blocking/unblocking of funds. Further, in terms of circulars prescribed by SEBI from time to time, the payment of processing fees to the SCSBs shall be undertaken pursuant to an application made by the SCSBs to the BRLMs, and such application shall be made only after (i) unblocking of application amounts for each application received by the SCSB has been fully completed, and (ii) applicable compensation relating to investor complaints has been paid by the SCSB.

The above timetable is indicative and does not constitute any obligation or liability on our Company or the Selling Shareholders or the Book Running Lead Managers.

Whilst our Company shall ensure that all steps for the completion of the necessary formalities for the listing and the commencement of trading of the Equity Shares on the Stock Exchanges are taken within such time as may be prescribed by SEBI, the timetable may be subject to change due to various factors, such as extension of the Bid/Offer Period by our Company and the Investor Selling Shareholder, in consultation with the Book Running Lead Managers, revision of the Price Band or any delay in receiving the final listing and trading approval from the Stock Exchanges or delay in receipt

of final certificates from SCSBs, etc. The commencement of trading of the Equity Shares will be entirely at the discretion of the Stock Exchanges and in accordance with the applicable laws. The Selling Shareholders confirm that they shall extend reasonable co-operation, in relation to their respective portion of the Offered Shares, as requested by our Company and/or the Book Running Lead Managers, for the timely completion of the necessary formalities for listing and commencement of trading of the Equity Shares at the Stock Exchanges within such time as may be prescribed by SEBI.

In terms of the UPI Circulars, in relation to the Offer, the Book Running Lead Managers will be required to submit reports of compliance with timelines and activities prescribed by SEBI in connection with the allotment and listing procedure within such time from the Bid/Offer Closing Date, as may be prescribed by SEBI, identifying non-adherence to timelines and processes and an analysis of entities responsible for the delay and the reasons associated with it.

In case of any delay in unblocking of amounts in the ASBA Accounts (including amounts blocked through the UPI Mechanism) exceeding four Working Days from the Bid/Offer Closing Date, the Bidder shall be compensated for the entire duration of delay exceeding four Working Days from the Bid/Offer Closing Date by the intermediary responsible for causing such delay in unblocking, in the manner specified in the UPI Circulars, to the extent applicable, which for the avoidance of doubt, shall be deemed to be incorporated herein. The Book Running Lead Managers shall, in their sole discretion, identify and fix the liability on such intermediary or entity responsible for such delay in unblocking.

Any circulars or notifications from SEBI after the date of this Red Herring Prospectus may result in changes to the listing timelines. Further, the offer procedure is subject to change basis any revised SEBI circulars to this effect.

Submission of Bids (other than Bids from Anchor Investors):

Bid/Offer Period (except the Bid/Offer Closing Date)	
Submission and Revision in Bids	Only between 10.00 a.m. and 5.00 p.m. (Indian Standard Time (“IST”))
Bid/Offer Closing Date	
Submission and Revision in Bids*	Only between 10.00 a.m. and 3.00 p.m. IST

* UPI mandate end time and date shall be at 5.00 pm on Bid/Offer Closing Date.

On the Bid/Offer Closing Date, the Bids shall be uploaded until:

- (i) 4.00 p.m. IST in case of Bids by QIBs and Non-Institutional Bidders, and
- (ii) until 5.00 p.m. IST or such extended time as permitted by the Stock Exchanges, in case of Bids by RIBs and Eligible Employees Bidding in the Employee Reservation Portion.

On Bid/Offer Closing Date, extension of time will be granted by Stock Exchanges only for uploading Bids received by RIBs and Eligible Employees Bidding under the Employee Reservation Portion after taking into account the total number of Bids received and as reported by the Book Running Lead Managers to the Stock Exchanges.

The Registrar to the Offer shall submit the details of cancelled/withdrawn/deleted applications to the SCSB’s on a daily basis within 60 minutes of the Bid closure time from the Bid/Offer Opening Date until the Bid/ Offer Closing Date by obtaining the same from the Stock Exchanges. The SCSB’s shall unblock such applications by the closing hours of the Working Day and submit the confirmation to the BRLMs and the Registrar to the Offer on a daily basis.

It is clarified that Bids shall be processed only after the application monies are blocked in the ASBA Account and Bids not uploaded on the electronic bidding system or in respect of which the full Bid Amount is not blocked by SCSBs or not blocked under the UPI Mechanism in the relevant ASBA Account, as the case may be, would be rejected.

Due to limitation of time available for uploading the Bids on the Bid/Offer Closing Date, Bidders are advised to submit their Bids one day prior to the Bid/Offer Closing Date. Any time mentioned in this Red Herring Prospectus is IST. Bidders are cautioned that, in the event a large number of Bids are received on the Bid/Offer Closing Date, some Bids may not get uploaded due to lack of sufficient time. Such Bids that cannot be uploaded will not be considered for allocation under the Offer. Bids will be accepted only during Monday to Friday (excluding any public holiday).

In case of any discrepancy in the data entered in the electronic book vis-à-vis the data contained in the physical Bid cum Application Form, for a particular Bidder, the details as per the Bid file received from the Stock Exchanges shall be taken as the final data for the purpose of Allotment.

Due to limitation of the time available for uploading the Bids on the Bid/Offer Closing Date, the Bidders are advised to submit their Bids one day prior to the Bid/Offer Closing Date and, in any case, no later than 1.00 p.m. (Indian Standard Time) on the Bid/ Offer Closing Date. Bidders are cautioned that, in the event a large number of Bids are received on the Bid/ Offer Closing Date, as is typically experienced in public offerings in India, it may lead to some Bids not being uploaded due to lack of sufficient time to upload. Such Bids that cannot be uploaded on the electronic bidding system will not be considered for allocation under this Offer. Bids and any revision in Bids will only be accepted on Working Days. Investors may please note that as per letter no. List/SMD/SM/2006 dated July 3, 2006 and letter no. NSE/IPO/25101- 6 dated July 6, 2006 issued by BSE and NSE respectively, Bids and any revision in Bids shall not be accepted on Saturdays and public holidays as declared by the

Stock Exchanges. Bids by ASBA Bidders shall be uploaded by the relevant Designated Intermediary in the electronic system to be provided by the Stock Exchanges. Neither our Company, nor the Selling Shareholders, nor any member of the Syndicate is liable for any failure in uploading or downloading the Bids due to faults in any software / hardware system or otherwise; or blocking of application amount by SCSBs on receipt of instructions from the Sponsor Banks due to any errors, omissions, or otherwise non-compliance by various parties involved in, or any other fault, malfunctioning or breakdown in the UPI Mechanism.

Our Company and the Investor Selling Shareholder, in consultation with the Book Running Lead Managers, reserves the right to revise the Price Band during the Bid/Offer Period in accordance with the SEBI ICDR Regulations. The revision in the Price Band shall not exceed 20% on either side, i.e. the Floor Price can move up or down to the extent of 20% of the Floor Price and the Cap Price will be revised accordingly, but the Floor Price shall not be less than the Face Value of the Equity Shares. In all circumstances, the Cap Price shall be less than or equal to 120% of the Floor Price provided that the Cap Price shall be at least 105% of the Floor Price.

In case of any revision to the Price Band, the Bid/Offer Period will be extended by at least three additional Working Days following such revision of the Price Band, subject to the Bid/Offer Period not exceeding 10 Working Days. In cases of force majeure, banking strike or similar circumstances, our Company may, for reasons to be recorded in writing, extend the Bid/Offer Period for a minimum of three Working Days, subject to the Bid/Offer Period not exceeding 10 Working Days. Any revision in the Price Band and the revised Bid/Offer Period, if applicable, will be widely disseminated by notification to the Stock Exchanges, by issuing a public notice, and also by indicating the change on the respective websites of the Book Running Lead Managers and at the terminals of the Syndicate Members and by intimation to Self-Certified Syndicate Banks (“SCSBs”), other Designated Intermediaries and the Sponsor Banks, as applicable.

Minimum Subscription

However, if our Company does not receive the minimum subscription in the Offer as specified under the terms of Rule 19(2)(b) of the SCRR, including through the devolvement of Underwriters, in accordance with the applicable laws, after the Bid/Offer Closing Date, or if the level of subscription falls below the threshold specified above on account of withdrawal of applications or after technical rejections or for any other reason whatsoever; or if the listing or trading permission are not obtained from the Stock Exchanges for the Equity Shares so offered under the Offer document, our Company and the Selling Shareholders, to the extent applicable, shall forthwith refund the entire subscription amount received. If there is a delay in refunding the amount beyond four days, our Company shall pay interest at the rate of 15% per annum in accordance with the UPI Circulars. The Selling Shareholders shall reimburse, to the extent of the Equity Shares offered by the Selling Shareholders in the Offer, any expenses and interest incurred by our Company on behalf of the Selling Shareholders for any delays in making refunds as required under the Companies Act, 2013, the UPI Circulars and any other applicable law, provided that the Selling Shareholders shall not be responsible or liable for payment of such expenses or interest if such delay is not attributable to an act or omission of such Selling Shareholders in relation to its portion of the Offered Shares.

In the event of under-subscription in the Offer, subject to receiving minimum subscription for 90% of the Fresh Issue and compliance with Rule 19(2)(b) of the SCRR, the Allotment for the valid Bids will be made in the first instance towards subscription for 90% of the Fresh Issue. If there remain any balance valid Bids in the Offer, the Allotment for the balance valid Bids will be made towards the sale of the Offered Shares being offered by the Selling Shareholders and only thereafter, towards the balance Fresh Issue. For avoidance of doubt, the balance Equity Shares of the Fresh Issue (i.e., 10% of the Fresh Issue) will be offered only once the entire portion of the Offered Shares are Allotted in the Offer.

Under subscription, if any, in any category except the QIB portion, would be met with spill-over from the other categories at the discretion of our Company and the Investor Selling Shareholder, in consultation with the Book Running Lead Managers, and the Designated Stock Exchange.

Further, our Company shall ensure that the number of prospective Allottees to whom the Equity Shares will be Allotted shall not be less than 1,000 in compliance with Regulation 49(1) of SEBI ICDR Regulations failing which the entire application money shall be unblocked in the respective ASBA Accounts of the Bidders. In case of delay, if any, in unblocking the ASBA Accounts within such timeline as prescribed under applicable laws, the Selling Shareholders and our Company shall be liable to pay interest on the application money in accordance with applicable laws.

Arrangements for Disposal of Odd Lots

Since the Equity Shares will be traded in dematerialised form only, and the market lot for our Equity Shares will be one Equity Share, no arrangements for disposal of odd lots are required.

New Financial Instruments

Our Company is not issuing any new financial instruments through this Offer.

Restrictions, if any on Transfer and Transmission of Equity Shares

Except for the lock-in of the pre-Offer Equity Share capital of our Company, lock-in of the Promoter's minimum contribution and the Anchor Investor lock-in as provided in "*Capital Structure*" beginning on page 81 and except as provided in the Articles of Association, there are no restrictions on transfer or transmission of Equity Shares. For details see "*Main Provisions of Articles of Association*" beginning on page 454.

OFFER STRUCTURE

The Offer is of up to [●] Equity Shares for cash at a price of ₹[●] each, aggregating up to ₹[●] million, comprising a Fresh Issue of up to [●] Equity Shares aggregating up to ₹1,800 million and an Offer for Sale of up to 17,236,808 Equity Shares aggregating up to ₹[●] million by Mahendrakumar Rameshwarlal Kabra, Hemant Mahendrakumar Kabra, Sumeet Mahendrakumar Kabra, Kabel Buildcon Solutions Private Limited, Ram Ratna Wires Limited and TPG Asia VII SF Pte. Ltd.

The Offer comprises of a Net Offer of up to [●] Equity Shares and Employee Reservation Portion of up to [●] Equity Shares. The Employee Reservation Portion shall not exceed 5% of our post-Offer paid-up Equity Share capital. The Offer and the Net Offer shall constitute [●]% and [●]%, respectively of the post-Offer paid-up Equity Share capital of our Company. Our Company and the Investor Selling Shareholder, in consultation with the Book Running Lead Managers, may offer a discount of up to [●]% of the Offer Price (equivalent of ₹[●] per Equity Share) to Eligible Employees Bidding in the Employee Reservation Portion, in accordance with the SEBI ICDR Regulations.

The Offer is being made through the Book Building Process.

Particulars	Eligible Employees [#]	QIBs ⁽¹⁾	Non-Institutional Bidders	RIBs
Number of Equity Shares available for Allotment or allocation ^{*(2)}	Up to [●] Equity Shares	Not more than [●] Equity Shares	Not less than [●] Equity Shares available for allocation or Offer less allocation to QIB Bidders and RIBs	Not less than [●] Equity Shares available for allocation or Offer less allocation to QIB Bidders and Non-Institutional Bidders
Percentage of Offer size available for Allotment or allocation	The Employee Reservation Portion shall constitute up to [●]% of the Offer Size	Not more than 50% of the Net Offer being available for allocation to QIB Bidders. However, up to 5% of the Net QIB Portion will be available for allocation proportionately to Mutual Funds only. Mutual Funds participating in the Mutual Fund Portion will also be eligible for allocation in the remaining QIB Portion. The unsubscribed portion in the Mutual Fund Portion will be added to the Net QIB Portion	Not less than 15% of the Net Offer or the Offer less allocation to QIB Bidders and RIBs was available for allocation. (a) one third of such portion shall be reserved for applicants with application size of more than ₹0.2 million and up to ₹1.00 million; and (b) two third of such portion shall be reserved for applicants with application size of more than ₹ 1 million, provided that the unsubscribed portion in either of such sub-categories may be allocated to applicants in the other sub-category of Non-Institutional Investors	Not less than 35% of the Net Offer or Offer less allocation to QIB Bidders and Non-Institutional Bidders
Basis of Allotment if respective category is oversubscribed*	Proportionate [#] ; unless the Employee Reservation Portion is undersubscribed, the value of allocation to an Eligible Employee shall not exceed ₹0.20 million. In the event of undersubscription in the Employee Reservation Portion, the unsubscribed portion may be allocated, on a proportionate basis, to Eligible Employees for a value exceeding ₹0.20 million, subject to total Allotment to an Eligible Employee not exceeding ₹0.50 million (net of Employee Discount).	Proportionate as follows (excluding the Anchor Investor Portion): a) Up to [●] Equity Shares shall be available for allocation on a proportionate basis to Mutual Funds only; and b) Up to [●] Equity Shares shall be available for allocation on a proportionate basis to all QIBs, including Mutual Funds receiving allocation as per (a) above. c) Up to 60% of the QIB Portion (of up to [●] Equity Shares) may be allocated on a discretionary basis to	The allotment to each NII shall not be less than the minimum application size, subject to availability of Equity Shares in the Non-Institutional Portion and the remaining available Equity Shares if any, shall be Allotted on a proportionate basis, in accordance with the conditions specified in the SEBI ICDR Regulations subject to: a) one third of the portion available to Non-Institutional Bidders being [●] Equity Shares are reserved for Bidders Biddings more than ₹0.20 million and up to ₹1.00 million;	The allotment to each Retail Individual Bidder shall not be less than the minimum Bid Lot, subject to availability of Equity Shares in the Retail Portion and the remaining available Equity Shares if any, shall be Allotted on a proportionate basis. For further details, see “Offer Procedure”, beginning on page 436.

Particulars	Eligible Employees [#]	QIBs ⁽¹⁾	Non-Institutional Bidders	RIBs
		Anchor Investors of which one-third shall be available for allocation to Mutual Funds only, subject to valid Bid received from Mutual Funds at or above the Anchor Investor Allocation Price.	b) two third of the portion available to Non-Institutional Bidders being [●] Equity Shares are reserved for Bidders Bidding more than ₹1.00 million. Provided that the unsubscribed portion in either of the categories specified in (a) or (b) above, may be allocated to Bidders in the other category.	
Mode of Bid [^]	ASBA only (including the UPI Mechanism)	ASBA only (excluding the UPI Mechanism) except for Anchor Investors ⁽³⁾	ASBA only (including the UPI Mechanism for Bids up to ₹0.50 million)	ASBA only (including the UPI Mechanism)
Minimum Bid	[●] Equity Shares and in multiples of [●] Equity Shares thereafter	[●] Equity Shares and in multiples of [●] Equity Shares thereafter	Such number of Equity Shares in multiples of [●] Equity Shares such that the Bid Amount exceeds ₹0.20 million	[●] Equity Shares
Maximum Bid	Such number of Equity Shares in multiples of [●] Equity Shares, so that the maximum Bid Amount by each Eligible Employee in Eligible Employee Portion does not exceed ₹0.50 million, less Employee Discount ^{##} , if any	Such number of Equity Shares in multiples of [●] Equity Shares not exceeding the size of the Offer, (excluding the Anchor portion), subject to limits applicable to each Bidder	Such number of Equity Shares in multiples of [●] Equity Shares not exceeding the size of the Offer (excluding the QIB Portion), subject to limits applicable to Bidder	Such number of Equity Shares in multiples of [●] Equity Shares so that the Bid Amount does not exceed ₹0.20 million
Mode of Allotment	Compulsorily in dematerialised form			
Bid Lot	[●] Equity Shares and in multiples of [●] Equity Shares thereafter			
Allotment Lot	A minimum of [●] Equity Shares and in multiples of one Equity Share thereafter			
Trading Lot	One Equity Share			
Who can apply ⁽⁴⁾	Eligible Employees (such that the Bid Amount does not exceed ₹0.50 million) net of Employee Discount.	Public financial institutions as specified in Section 2(72) of the Companies Act 2013, scheduled commercial banks, multilateral and bilateral development financial institutions, mutual funds registered with SEBI, FPIs other than individuals, corporate bodies and family offices, VCFs, AIFs, FVCIs, registered with SEBI, state industrial development corporation, insurance company registered with IRDAI, provident fund with minimum corpus of ₹250 million, pension fund with minimum corpus of ₹250 million, National Investment Fund set up by the Government of India, insurance funds set up and managed by army, navy or air force of the Union of India, insurance funds set up and managed by the	Resident Indian individuals, Eligible NRIs, HUFs (in the name of Karta), companies, corporate bodies, scientific institutions, societies, family offices, trusts, FPIs who are individuals, corporate bodies and family offices.	Resident Indian individuals, HUFs (in the name of Karta) and Eligible NRIs applying for Equity Shares such that the Bid amount does not exceed ₹0.20 million in value.

Particulars	Eligible Employees [#]	QIBs ⁽¹⁾	Non-Institutional Bidders	RIBs
		Department of Posts, India and Systemically Important NBFCS, in accordance with applicable laws including FEMA Rules.		
Terms of Payment	<p>In case of Anchor Investors: Full Bid Amount shall be payable by the Anchor Investors at the time of submission of their Bids.⁽⁵⁾</p> <p>In case of all other Bidders: Full Bid Amount shall be blocked by the SCSBs in the bank account of the ASBA Bidder, or by the Sponsor Banks through the UPI Mechanism, that is specified in the ASBA Form at the time of submission of the ASBA Form.</p>			

* Assuming full subscription in the Offer.

[^] SEBI vide its circular no. SEBI/HO/CFD/DIL2/P/CIR/2022/75 dated May 30, 2022, has mandated that ASBA applications in Public Issues shall be processed only after the application monies are blocked in the bank accounts of the investors. Accordingly, Stock Exchanges shall, for all categories of investors viz. QIBs, NIBs and RIBs and also for all modes through which the applications are processed, accept the ASBA applications in their electronic book building platform only with a mandatory confirmation on the application monies blocked.

[#] Eligible Employees Bidding in the Employee Reservation Portion can Bid up to a Bid Amount of ₹0.50 million (net of Employee Discount). However, a Bid by an Eligible Employee in the Employee Reservation Portion will be considered for allocation, in the first instance, for a Bid Amount of up to ₹0.20 million. In the event of under-subscription in the Employee Reservation Portion the unsubscribed portion will be available for allocation and Allotment, proportionately to all Eligible Employees who have Bid in excess of ₹0.20 million, subject to the maximum value of Allotment made to such Eligible Employee not exceeding ₹0.50 million (net of Employee Discount). Further, an Eligible Employee Bidding in the Employee Reservation Portion can also Bid in the Net Offer and such Bids will not be treated as multiple Bids subject to applicable limits. Eligible Employee can also apply under Retail Portion. However, Bids by Eligible Employees in the Employee Reservation Portion and in the Non-Institutional Portion shall be treated as multiple Bids, only if Eligible Employee has made an application of more than ₹0.20 million in the Employee reservation portion. In case of under-subscription in the Net Offer, spill-over to the extent of such under-subscription shall be permitted from the Employee Reservation Portion.

^{##} Our Company and the Investor Selling Shareholder, in consultation with the BRLMs, may offer a discount of up to [●]% (equivalent of ₹[●] per Equity Share) to the Offer Price to Eligible Employees Bidding in the Employee Reservation Portion and which shall be announced at least two Working Days prior to the Bid/ Offer Opening Date.

- (1) Our Company and the Investor Selling Shareholder, in consultation with the Book Running Lead Managers, may allocate up to 60% of the QIB Portion to Anchor Investors at the Anchor Investor Offer Price, on a discretionary basis, subject to there being (i) a maximum of two Anchor Investors, where allocation in the Anchor Investor Portion is up to ₹100 million, (ii) minimum of two and maximum of 15 Anchor Investors, where the allocation under the Anchor Investor Portion is more than ₹100 million but up to ₹2,500 million under the Anchor Investor Portion, subject to a minimum Allotment of ₹50 million per Anchor Investor, and (iii) in case of allocation above ₹2,500 million under the Anchor Investor Portion, a minimum of five such investors and a maximum of 15 Anchor Investors for allocation up to ₹2,500 million, and an additional 10 Anchor Investors for every additional ₹2,500 million or part thereof will be permitted, subject to minimum allotment of ₹50 million per Anchor Investor. An Anchor Investor will make a minimum Bid of such number of Equity Shares, that the Bid Amount is at least ₹100 million. One-third of the Anchor Investor Portion will be reserved for domestic Mutual Funds, subject to valid Bids being received at or above the price at which allocation is made to Anchor Investors.
- (2) Subject to valid Bids being received at or above the Offer Price. This is an Offer in terms of Rule 19(2)(b) of the SCRR and Regulation 6(1) of the SEBI ICDR Regulations, wherein not more than 50% of the Net Offer shall be available for allocation on a proportionate basis to Qualified Institutional Buyers. Such number of Equity Shares representing 5% of the Net QIB Portion shall be available for allocation on a proportionate basis to Mutual Funds only. The remainder of the Net QIB Portion shall be available for allocation on a proportionate basis to QIBs, including Mutual Funds, subject to valid Bids being received from them at or above the Offer Price. However, if the aggregate demand from Mutual Funds is less than 5% of the Net QIB Portion, the balance Equity Shares available for allocation in the Mutual Fund Portion will be added to the remaining Net QIB Portion for proportionate allocation to all QIBs. Further, subject to availability of Equity Shares in the respective categories, not less than 15% of the Net Offer shall be available for allocation to Non-Institutional Bidders and not less than 35% of the Net Offer shall be available for allocation to RIBs, in accordance with the SEBI ICDR Regulations, subject to valid Bids being received at or above the Offer Price.
- (3) Anchor Investors are not permitted to use the ASBA process.
- (4) In the event that a Bid is submitted in joint names, the relevant Bidders should ensure that the depository account is also held in the same joint names and the names are in the same sequence in which they appear in the Bid cum Application Form. The Bid cum Application Form should contain only the name of the First Bidder whose name should also appear as the first holder of the beneficiary account held in joint names. The signature of only such First Bidder would be required in the Bid cum Application Form and such First Bidder would be deemed to have signed on behalf of the joint holders. Our Company reserves the right to reject, in its absolute discretion, all or any multiple Bids in any or all categories.
- (5) Full Bid Amount shall be payable by the Anchor Investors at the time of submission of the Anchor Investor Application Forms provided that any difference between the Anchor Investor Allocation Price and the Anchor Investor Offer Price shall be payable by the Anchor Investor Pay-In Date as indicated in the CAN.

Eligible Employees Bidding in the Employee Reservation Portion at a price within the Price Band can make payment based on Bid Amount, at the time of making a Bid. Eligible Employees Bidding in the Employee Reservation Portion at the Cut-Off Price have to ensure payment at the Cap Price, at the time of making a Bid.

Subject to valid Bids being received at or above the Offer Price, under-subscription, if any, in the Non-Institutional Portion, the Retail Portion would be allowed to be met with spill-over from other categories or a combination of categories at the discretion of our Company and the Investor Selling Shareholder, in consultation with the BRLMs and the Designated Stock Exchange, on a proportionate basis. However, under-subscription, if any, in the QIB Portion will not be allowed to be met with spill-over from other categories or a combination of categories. For further details, see “Terms of the Offer” beginning on page 427.

OFFER PROCEDURE

All Bidders should read the General Information Document for investing in public issues prepared and issued in accordance with the circular no. SEBI/HO/CFD/DIL1/CIR/P/2020/37 dated March 17, 2020 issued by SEBI and the UPI Circulars (the “**General Information Document**”) which highlights the key rules, processes and procedures applicable to public issues in general in accordance with the provisions of the Companies Act, the SCRA, the SCRR and the SEBI ICDR Regulations which is part of the abridged prospectus accompanying the Bid cum Application Form. The General Information Document is available on the websites of the Stock Exchanges and the Book Running Lead Managers. Please refer to the relevant provisions of the General Information Document which are applicable to the Offer especially in relation to the process for Bids by the UPI Bidders. The investors should note that the details and process provided in the General Information Document should be read along with this section.

Additionally, all Bidders may refer to the General Information Document for information in relation to (i) category of investors eligible to participate in the Offer; (ii) maximum and minimum Bid size; (iii) price discovery and allocation; (iv) payment instructions for ASBA Bidders; (v) issuance of Confirmation of Allocation Note (“**CAN**”) and Allotment in the Issue; (vi) general instructions (limited to instructions for completing the Bid cum Application Form); (vii) designated date; (viii) disposal of applications; (ix) submission of Bid cum Application Form; (x) other instructions (limited to joint bids in cases of individual, multiple bids and instances when an application would be rejected on technical grounds); (xi) applicable provisions of the Companies Act relating to punishment for fictitious applications; (xii) mode of making refunds; and (xiii) interest in case of delay in Allotment or refund.

SEBI vide its circular no. SEBI/HO/CFD/DIL2/CIR/P/2018/138 dated November 1, 2018 read with its circular no. SEBI/HO/CFD/DIL2/CIR/P/2019/50 dated April 3, 2019, had introduced an alternate payment mechanism using Unified Payments Interface (“**UPI**”) and consequent reduction in timelines for listing in a phased manner. From January 1, 2019, the UPI Mechanism for RIBs applying through Designated Intermediaries was made effective along with the existing process and existing timeline of T+6 days. (“**UPI Phase I**”). The UPI Phase I was effective till June 30, 2019. Pursuant to its circular no. SEBI/HO/CFD/DIL2/P/CIR/P/2022/45 dated April 5, 2022, the SEBI has increased the UPI limit from ₹0.20 million to ₹0.50 million for all the individual investors applying in public issues.

With effect from July 1, 2019, SEBI vide its circular no. SEBI/HO/CFD/DIL2/CIR/P/2019/76 dated June 28, 2019, read with circular no. SEBI/HO/CFD/DIL2/CIR/P/2019/85 dated July 26, 2019 with respect to Bids by RIBs through Designated Intermediaries (other than SCSBs), the existing process of physical movement of forms from such Designated Intermediaries to SCSBs for blocking of funds was discontinued and only the UPI Mechanism for such Bids with existing timeline of T+6 days was mandated for a period of three months or launch of five main board public issues, whichever is later (“**UPI Phase II**”) and this phase was to continue till March 31, 2020 and post which reduced timeline from T+6 days to T+3 days was to be made effective using the UPI Mechanism for applications by RIBs (“**UPI Phase III**”). Subsequently, however, SEBI vide its circular no. SEBI/HO/CFD/DIL2/CIR/P/2020/50 dated March 30, 2020, continued the UPI Phase II till further notice. SEBI, vide its circular no. SEBI/HO/CFD/TPD1/CIR/P/2023/140 dated August 9, 2023 (the “**T+3 Circular**”), has made reduced timeline of T+3 days effective on a voluntary basis for all public issues opening on or after September 1, 2023 and on a mandatory basis for all public issues opening on or after December 1, 2023. The Offer will be undertaken pursuant to the processes and procedures under UPI Phase II, subject to any circulars, clarification or notification issued by the SEBI from time to time. Further, SEBI vide its circular no. SEBI/HO/CFD/DIL2/CIR/P/2021/2480/1/M dated March 16, 2021, had introduced certain additional measures for streamlining the process of initial public offers and redressing investor grievances, which came into force with effect from May 1, 2021, except as amended pursuant to SEBI circular no. SEBI/HO/CFD/DIL2/P/CIR/2021/570 dated June 2, 2021 and SEBI circular no. SEBI/HO/CFD/DIL2/CIR/P/2022/51 dated April 20, 2022, SEBI circular number SEBI/HO/CFD/DIL2/P/CIR/2022/75 dated May 30, 2022, along with the circular issued by the National Stock Exchange of India Limited having reference no. 25/2022 dated August 3, 2022 and the circular issued by BSE Limited having reference no. 20220803-40 dated August 3, 2022. The provisions of these circulars are deemed to form part of this Red Herring Prospectus. Subsequently, the SEBI RTA Master Circular consolidated the aforementioned circulars to the extent relevant for RTAs, and rescinded these circulars.

Bidders are advised to make their independent investigations and ensure that their Bids are submitted in accordance with applicable laws and do not exceed the investment limits or maximum number of the Equity Shares that can be held by them under applicable law or as specified in this Red Herring Prospectus and the Prospectus.

Further, our Company, the Selling Shareholders and the Syndicate are not liable for any adverse occurrences consequent to the implementation of the UPI Mechanism for application in this Offer.

Book Building Procedure

The Offer is being made in terms of Rule 19(2)(b) of the SCRR through the Book Building Process in accordance with Regulation 6(1) of the SEBI ICDR Regulations, wherein not more than 50% of the Net Offer shall be allocated on a proportionate basis to QIBs. Our Company and the Investor Selling Shareholder shall, in consultation with the Book Running Lead Managers, allocate up to 60% of the QIB Portion to Anchor Investors at the Anchor Investor Allocation Price, on a discretionary basis in accordance with the SEBI ICDR Regulations, out of which one-third shall be available for allocation to

domestic Mutual Funds, subject to valid Bids being received from domestic Mutual Funds at or above the Anchor Investor Allocation Price. In the event of under-subscription, or non-allocation in the Anchor Investor Portion, the balance Equity Shares shall be added to the Net QIB Portion. Further, 5% of the Net QIB Portion shall be available for allocation on a proportionate basis only to Mutual Funds, and the remainder of the Net QIB Portion shall be available for allocation on a proportionate basis to all QIBs (other than Anchor Investors), including Mutual Funds, subject to valid Bids being received at or above the Offer Price. Further, subject to availability of Equity Shares in the respective categories, not less than 15% of the Net Offer shall be available for allocation to Non-Institutional Bidders and not less than 35% of the Net Offer shall be available for allocation to RIBs, in accordance with the SEBI ICDR Regulations, subject to valid Bids being received at or above the Offer Price. Furthermore, up to [●] Equity Shares, aggregating to ₹108.00 million shall be made available for allocation on a proportionate basis only to Eligible Employees Bidding in the Employee Reservation Portion, subject to valid Bids being received at or above the Offer Price, if any. The Employee Reservation Portion shall not exceed 5% of our post -Offer paid-up equity share capital subject to valid Bids being received at or above the Offer Price, net of Employee Discount, if any.

Subject to valid Bids being received at or above the Offer Price, under-subscription, if any, in any category except in the QIB Portion, would be allowed to be met with spill-over from any other category or combination of categories, at the discretion of our Company and the Investor Selling Shareholder, in consultation with the Book Running Lead Managers, and the Designated Stock Exchange and subject to applicable laws. Under-subscription, if any, in the QIB Portion, would not be allowed to be met with spill-over from any other category or a combination of categories. Further, in the event of an under-subscription in the Employee Reservation Portion, such unsubscribed portion may be Allotted on a proportionate basis to Eligible Employees Bidding in the Employee Reservation Portion, for a value in excess of ₹0.20 million, subject to the total Allotment to an Eligible Employee not exceeding ₹0.50 million (net of Employee Discount). The unsubscribed portion, if any, in the Employee Reservation Portion shall be added to the Net Offer.

The Equity Shares, on Allotment, shall be traded only in the dematerialised segment of the Stock Exchanges.

Bidders should note that the Equity Shares will be Allotted to all successful Bidders only in dematerialised form. The Bid cum Application Forms, which do not have the details of the Bidders' depository account, including DP ID, Client ID, UPI ID (in case of UPI Bidders using the UPI Mechanism) and PAN, shall be treated as incomplete and will be rejected. Bidders will not have the option of being Allotted Equity Shares in physical form. However, they may get the Equity Shares rematerialised subsequent to Allotment of the Equity Shares in the Offer, subject to applicable laws.

Phased implementation of unified payments interface

SEBI has issued the UPI Circulars in relation to streamlining the process of public issue of *inter alia*, equity shares. Pursuant to the UPI Circulars, the UPI Mechanism has been introduced in a phased manner as a payment mechanism (in addition to mechanism of blocking funds in the account maintained with SCSBs under ASBA) for applications by RIBs through Designated Intermediaries with the objective to reduce the time duration from public issue closure to listing from six Working Days to up to three Working Days. Considering the time required for making necessary changes to the systems and to ensure complete and smooth transition to the UPI payment mechanism, the UPI Circulars have introduced the UPI Mechanism in three phases in the following manner:

Phase I: This phase was applicable from January 1, 2019 until March 31, 2019 or floating of five main board public issues, whichever was later. Subsequently, the timeline for implementation of Phase I was extended till June 30, 2019. Under this phase, a RIB had the option to submit the ASBA Form with any of the Designated Intermediary and use his/ her UPI ID for the purpose of blocking of funds. The time duration from public issue closure to listing continued to be six Working Days.

Phase II: This phase has become applicable from July 1, 2019 and was to initially continue for a period of three months or floating of five main board public issues, whichever is later. SEBI vide its circular no. SEBI/HO/CFD/DCR2/CIR/P/2019/133 dated November 8, 2019 extended the timeline for implementation of UPI Phase II till March 31, 2020. Further, pursuant to SEBI circular dated March 30, 2020, this phase was extended till further notice. Under this phase, submission of the ASBA Form without UPI by RIBs through Designated Intermediaries (other than SCSBs) to SCSBs for blocking of funds was discontinued and replaced by the UPI Mechanism. However, the time duration from public issue closure to listing continued to be six Working Days during this phase.

Phase III/T+3: This phase has become applicable on a voluntary basis for all issues opening on or after September 1, 2023 and on a mandatory basis for all issues opening on or after December 1, 2023. In this phase, the time duration from public issue closure to listing has been reduced to three Working Days.

The Offer will be undertaken pursuant to the processes and procedures under UPI Phase II, subject to any circulars, clarification or notification issued by the SEBI from time to time.

For further details, refer to the General Information Document available on the websites of the Stock Exchanges and the Book Running Lead Managers.

Pursuant to the SEBI circular no. SEBI/HO/CFD/DIL2/CIR/P/2021/2480/1/M dated March 16, 2021 issued by SEBI, as amended by the SEBI circular no. SEBI/HO/CFD/DIL2/P/CIR/2021/570 dated June 2, 2021 and SEBI circular no. SEBI/HO/CFD/DIL2/CIR/P/2022/51 dated April 20, 2022 (the "UPI Streamlining Circular"), SEBI has set out specific

requirements for redressal of investor grievances for applications that have been made through the UPI Mechanism. The requirements of the UPI Streaming Circular include, appointment of a nodal officer by the SCSB and submission of their details to SEBI, the requirement for SCSBs to send SMS alerts for the blocking and unblocking of UPI mandates, the requirement for the Registrar to submit details of cancelled, withdrawn or deleted applications, and the requirement for the bank accounts of unsuccessful Bidders to be unblocked no later than one day from the date on which the Basis of Allotment is finalised. Failure to unblock the accounts within the timeline would result in the SCSBs being penalised under the relevant securities law. Additionally, if there is any delay in the redressal of investors' complaints, the relevant SCSB as well as the post-Offer BRLM will be required to compensate the concerned investor.

The processing fees for applications made by UPI Bidders using the UPI Mechanism may be released to the remitter banks (SCSBs) only after such banks provide a written confirmation on compliance with SEBI circular no. SEBI/HO/CFD/DIL2/P/CIR/2021/570 dated June 2, 2021 read with SEBI circular no. SEBI/HO/CFD/DIL2/CIR/P/2021/2480/1/M dated March 16, 2021 and SEBI circular no. SEBI/HO/CFD/DIL2/CIR/P/2022/51 dated April 20, 2022.

All SCSBs offering facility of making application in public issues shall also provide facility to make application using UPI.

The Offer is being made under Phase II of the UPI, unless Phase III of the UPI becomes effective and applicable on or prior to the Bid/Offer Opening Date. Our Company will be required to appoint one of the SCSBs as a sponsor bank to act as a conduit between the Stock Exchanges and NPCI in order to facilitate collection of requests and / or payment instructions of the Retail Individual Bidders using the UPI.

For further details, refer to the General Information Document available on the websites of the Stock Exchanges and the BRLMs.

Bid cum Application Form

Copies of the Bid cum Application Form (other than for Anchor Investors) and the abridged prospectus will be available with the Designated Intermediaries at the relevant Bidding Centres, and at our Corporate Office. An electronic copy of the Bid cum Application Form will also be available for download on the websites of NSE (www.nseindia.com) and BSE (www.bseindia.com) at least one day prior to the Bid / Offer Opening Date.

Copies of the Anchor Investor Application Form will be available at the offices of the Book Running Lead Managers.

All Bidders (other than Anchor Investors) shall mandatorily participate in the Offer only through the ASBA process. Anchor Investors are not permitted to participate in the Offer through the ASBA process. The UPI Bidders can additionally Bid through the UPI Mechanism.

ASBA Bidders (not using the UPI Mechanism) must provide bank account details and authorisation to block funds in their respective ASBA Accounts in the relevant space provided in the ASBA Form and the ASBA Forms that do not contain such details are liable to be rejected. The ASBA Bidders shall ensure that they have sufficient balance in their bank accounts to be blocked through ASBA for their respective Bid as the application made by a Bidder shall only be processed after the Bid amount is blocked in the ASBA account of the Bidder pursuant to SEBI circular number SEBI/HO/CFD/DIL2/P/CIR/2022/75 dated May 30, 2022, which shall be effective from September 1, 2022.

All ASBA Bidders are required to provide either, (i) bank account details and authorizations to block funds in the ASBA Form; or (ii) the UPI ID (in case of UPI Bidders), as applicable, in the relevant space provided in the ASBA Form and the ASBA Forms that did not contain such details will be rejected. Applications made by the UPI Bidders using third party bank account or using third party linked bank account UPI ID are liable to be rejected.

The UPI Bidders must provide the valid UPI ID in the relevant space provided in the Bid cum Application Form and the Bid cum Application Forms that do not contain the UPI ID are liable to be rejected. ASBA Bidders shall ensure that the Bids are made on ASBA Forms bearing the stamp of the Designated Intermediary, submitted at the Bidding Centres only (except in case of electronic ASBA Forms) and the ASBA Forms not bearing such specified stamp are liable to be rejected. UPI Bidders using UPI Mechanism, may submit their ASBA Forms, including details of their UPI IDs, with the Syndicate, sub-Syndicate members, Registered Brokers, RTAs or CDPs. RIBs authorising an SCSB to block the Bid Amount in the ASBA Account may submit their ASBA Forms with the SCSBs. ASBA Bidders must ensure that the ASBA Account has sufficient credit balance such that an amount equivalent to the full Bid Amount can be blocked by the SCSB or the Sponsor Banks, as applicable at the time of submitting the Bid. In order to ensure timely information to investors, SCSBs are required to send SMS alerts to investors intimating them about Bid Amounts blocked/ unblocked.

Anchor Investors are not permitted to participate in the Issue through the ASBA process. For Anchor Investors, the Anchor Investor Application is available with the Book Running Lead Managers.

The prescribed colour of the Bid cum Application Form for the various categories is as follows:

Category	Colour of Bid cum Application Form*
Resident Indians, including QIBs, Non-institutional Investors and Retail Individual Bidders, each resident in India and Eligible NRIs applying on a non-repatriation basis	White
Non-Residents including Eligible NRIs, their sub-accounts (other than sub-accounts which are foreign corporates or foreign individuals under the QIB Portion), FPIs or FVCIs registered multilateral and bilateral development financial institutions applying on a repatriation basis	Blue
Anchor Investors**	White
Eligible Employees Bidding in the Employee Reservation Portion	Pink

* Excluding electronic Bid cum Application Form.

** Bid cum Application Forms for Anchor Investors will be made available at the office of the Book Running Lead Managers.

Electronic Bid cum Application forms will also be available for download on the website of NSE (www.nseindia.com) and BSE (www.bseindia.com).

The Designated Intermediaries (other than SCSBs) shall submit/deliver the Bid cum Application Form to the respective SCSB, where the Bidder has a bank account and shall not submit it to any non-SCSB bank or any Escrow Bank. Further, SCSBs shall upload the relevant Bid details (including UPI ID in case of ASBA Forms under the UPI Mechanism) in the electronic bidding system of the Stock Exchanges. Stock Exchanges shall validate the electronic bids with the records of the CDP for DP ID/Client ID and PAN, on a real time basis and bring inconsistencies to the notice of the relevant Designated Intermediaries, for rectification and re-submission within the time specified by Stock Exchanges. Stock Exchanges shall allow modification of either DP ID/Client ID or PAN ID, bank code and location code in the Bid details already uploaded.

In case of ASBA Forms, the relevant Designated Intermediaries shall upload the relevant Bid details in the electronic bidding system of the Stock Exchanges. Designated Intermediaries (other than SCSBs) shall submit/deliver the ASBA Forms (except Bid cum Application Forms submitted by UPI Bidders) to the respective SCSB, where the Bidder has a bank account and shall not submit it to any non-SCSB bank or any Escrow Collection Bank(s). For UPI Bidders using the UPI Mechanism, the Stock Exchanges shall share the Bid details (including UPI ID) with the Sponsor Banks on a continuous basis through API integration to enable the Sponsor Banks to initiate a UPI Mandate Request to such UPI Bidders for blocking of funds. The Sponsor Banks shall initiate request for blocking of funds through NPCI to UPI Bidders, who shall accept the UPI Mandate Request for blocking of funds on their respective mobile applications associated with UPI ID linked bank account. The NPCI shall maintain an audit trail for every Bid entered in the Stock Exchanges bidding platform, and the liability to compensate UPI Bidders (Bidding through UPI Mechanism) in case of failed transactions shall be with the concerned entity (i.e., the Sponsor Banks, NPCI or the Bankers to the Offer) at whose end the lifecycle of the transaction has come to a halt. The NPCI shall share the audit trail of all disputed transactions/ investor complaints to the Sponsor Banks and the Bankers to the Offer. The Sponsor Banks and the Bankers to the Offer shall provide the audit trail to the BRLMs for analysing the same and fixing liability. For ensuring timely information to investors, SCSBs shall send SMS alerts as specified in SEBI circular no. SEBI/HO/CFD/DIL2/CIR/P/2021/2480/1/M dated March 16, 2021, as amended pursuant to SEBI circular no. SEBI/HO/CFD/DIL2/P/CIR/2021/570 dated June 2, 2021 and the SEBI circular no. SEBI/HO/CFD/DIL2/CIR/P/2022/51 dated April 20, 2022.

For all pending UPI Mandate Requests, the Sponsor Banks shall initiate requests for blocking of funds in the ASBA Accounts of relevant Bidders with a confirmation cut-off time of 5:00 pm on the Bid/Offer Closing Date (“**Cut-Off Time**”). Accordingly, UPI Bidders should accept UPI Mandate Requests for blocking of funds prior to the Cut-Off Time and all pending UPI Mandate Requests at the Cut-Off Time shall lapse.

The Equity Shares have not been and will not be registered, listed or otherwise qualified in any other jurisdiction outside India and may not be offered or sold, and Bids may not be made by persons in any such jurisdiction, except in compliance with the applicable laws of such jurisdiction.

Electronic registration of Bids

- The Designated Intermediary may register the Bids using the on-line facilities of the Stock Exchanges. The Designated Intermediaries can also set up facilities for off-line electronic registration of Bids, subject to the condition that they may subsequently upload the off-line data file into the on-line facilities for Book Building on a regular basis before the closure of the Offer.
- On the Bid/Offer Closing Date, the Designated Intermediaries may upload the Bids till such time as may be permitted by the Stock Exchanges and as disclosed in this Red Herring Prospectus.

Only Bids that are uploaded on the Stock Exchanges Platform are considered for allocation/Allotment. The Designated Intermediaries are given till 5:00 pm on the Bid/Offer Closing Date to modify select fields uploaded in the Stock Exchange Platform during the Bid/Offer Period after which the Stock Exchange(s) send the bid information to the Registrar to the Offer for further processing.

Participation by Promoters, Promoter Group, the Book Running Lead Managers, the Syndicate Members and persons related to Promoters/Promoter Group/the Book Running Lead Managers

The Book Running Lead Managers and the Syndicate Members shall not be allowed to purchase Equity Shares in this Offer in any manner, except towards fulfilling their underwriting obligations. However, the associates and affiliates of the Book Running

Lead Managers and the Syndicate Members may Bid for Equity Shares in the Offer, either in the QIB Portion or in the Non-Institutional Portion as may be applicable to such Bidders, where the allocation is on a proportionate basis or in any other manner as introduced under applicable laws, and such subscription may be on their own account or on behalf of their clients. All categories of investors, including associates or affiliates of the Book Running Lead Managers and Syndicate Members, shall be treated equally for the purpose of allocation to be made on a proportionate basis.

Except as stated below, neither the Book Running Lead Managers nor any associate of the Book Running Lead Managers can apply in the Offer under the Anchor Investor Portion:

- (i) mutual funds sponsored by entities which are associate of the Book Running Lead Managers;
- (ii) insurance companies promoted by entities which are associate of the Book Running Lead Managers;
- (iii) AIFs sponsored by the entities which are associate of the Book Running Lead Managers; or
- (iv) FPIs other than individuals, corporate bodies and family offices sponsored by the entities which are associate of the Book Running Lead Managers.

Except to the extent of participation in the Offer for Sale by Mahendrakumar Rameshwarlal Kabra, who is one of the Promoters of our Company, and of Sumeet Mahendrakumar Kabra, Hemant Mahendrakumar Kabra and Kabel Buildcon Solutions Private Limited, who are members of the Promoter Group of our Company, the members of the Promoter Group shall not participate by applying for Equity Shares in the Offer. Further, persons related to the Promoters and Promoter Group shall not apply in the Offer under the Anchor Investor Portion. A qualified institutional buyer who has any of the following rights in relation to the Company shall also be deemed to be a person related to the Promoters or Promoter Group of our Company:

- (i) rights under a Shareholders agreement or voting agreement entered into with the Promoters or Promoter Group of our Company;
- (ii) veto rights; or
- (iii) right to appoint any nominee director on our Board.

Further, an Anchor Investor shall be deemed to be an “associate of the Book Running Lead Managers ” if:

- (i) either of them controls, directly or indirectly through its subsidiary or holding company, not less than 15% of the voting rights in the other; or
- (ii) either of them, directly or indirectly, by itself or in combination with other persons, exercises control over the other; or
- (iii) there is a common director, excluding nominee director, amongst the Anchor Investors, the Book Running Lead Managers.

Bids by Mutual Funds

With respect to Bids by Mutual Funds, a certified copy of their SEBI registration certificate must be lodged along with the Bid cum Application Form. Failing this, our Company and the Investor Selling Shareholder, in consultation with the Book Running Lead Managers, reserve the right to reject any Bid without assigning any reason thereof, subject to applicable law.

Bids made by asset management companies or custodians of Mutual Funds shall specifically state names of the concerned schemes for which such Bids are made.

In case of a Mutual Fund, a separate Bid can be made in respect of each scheme of the Mutual Fund registered with SEBI and such Bids in respect of more than one scheme of the Mutual Fund will not be treated as multiple Bids provided that the Bids clearly indicate the scheme concerned for which such Bid has been made.

No Mutual Fund scheme shall invest more than 10% of its NAV in equity shares or equity-related instruments of any single company, provided that the limit of 10% shall not be applicable for investments in case of index funds or sector or industry specific schemes. No Mutual Fund under all its schemes should own more than 10% of any company’s paid-up share capital carrying voting rights.

Bids by Eligible Non-Resident Indians

Eligible NRIs Bidding on non-repatriation basis are advised to use the Bid cum Application Form for residents (white in colour). Eligible NRIs Bidding on a repatriation basis are advised to use the Bid cum Application Form meant for Non-Residents (blue in colour).

Eligible NRIs may obtain copies of Bid cum Application Form from the Designated Intermediaries. Only Bids accompanied by payment in Indian Rupees or freely convertible foreign exchange will be considered for Allotment. Eligible NRI Bidders

Bidding on a repatriation basis by using the Non-Resident Forms should authorise their respective SCSB to block their NRE accounts, or Foreign Currency Non-Resident (“FCNR”) Accounts, and eligible NRI Bidders Bidding on a non-repatriation basis by using Resident Forms should authorise their respective SCSB to block their NRO accounts for the full Bid Amount, at the time of the submission of the Bid cum Application Form. Eligible NRIs applying on a non-repatriation basis in the Offer through the UPI Mechanism are advised to enquire with their relevant bank, whether their account is UPI linked, prior to submitting a Bid cum Application Form.

In accordance with the FEMA Rules, the total holding by any individual NRI, on a repatriation basis, shall not exceed 5% of the total paid-up equity capital on a fully diluted basis or shall not exceed 5% of the paid-up value of each series of debentures or preference shares or share warrants issued by an Indian company and the total holdings of all NRIs and OCIs put together shall not exceed 10% of the total paid-up equity capital on a fully diluted basis or shall not exceed 10% of the paid-up value of each series of debentures or preference shares or share warrant. Provided that the aggregate ceiling of 10% may be raised to 24% if a special resolution to that effect is passed by the members of the Indian company in a general meeting.

For details of restrictions on investment by NRIs, see “*Restrictions on Foreign Ownership of Indian Securities*” beginning on page 453.

Participation of Eligible NRIs in the Offer shall be subject to the FEMA Rules. Only Bids accompanied by payment in Indian rupees or fully converted foreign exchange will be considered for Allotment.

Bids by HUFs

Hindu Undivided Families or HUFs, in the individual name of the *Karta*. The Bidder/Applicant should specify that the Bid is being made in the name of the HUF in the Bid cum Application Form/Application Form as follows: “Name of sole or first Bidder/applicant: XYZ Hindu Undivided Family applying through XYZ, where XYZ is the name of the *Karta*. Bids/Applications by HUFs may be considered at par with Bids/Applications from individuals.

Bids by FPIs

In terms of applicable FEMA Rules and the SEBI FPI Regulations, investments by FPIs in the Equity Shares is subject to certain limits, *i.e.*, the individual holding of an FPI (including its investor group (which means multiple entities registered as foreign portfolio investors and directly or indirectly, having common ownership of more than 50% or common control)) shall be below 10% of our post-Offer Equity Share capital on a fully diluted basis. In case the total holding of an FPI or investor group increases beyond 10% of the total paid-up Equity Share capital of our Company, on a fully diluted basis, the total investment made by the FPI or investor group will be re-classified as FDI subject to the conditions as specified by SEBI and the RBI in this regard and our Company and the investor will be required to comply with applicable reporting requirements. Further, the total holdings of all FPIs put together, with effect from April 1, 2020, can be up to the sectoral cap applicable to the sector in which our Company operates (*i.e.*, up to 100%). In terms of the FEMA Rules, for calculating the aggregate holding of FPIs in a company, holding of all registered FPIs shall be included.

In case of Bids made by FPIs, a certified copy of the certificate of registration issued under the SEBI FPI Regulations is required to be attached to the Bid cum Application Form, failing which our Company reserves the right to reject any Bid without assigning any reason. FPIs who wish to participate in the Offer are advised to use the Bid cum Application Form for Non-Residents (blue in colour).

In case the total holding of an FPI increases beyond 10% of the total paid-up Equity Share capital, on a fully diluted basis or 10% or more of the paid-up value of any series of debentures or preference shares or share warrants issued that may be issued by our Company, the total investment made by the FPI will be re-classified as FDI subject to the conditions as specified by SEBI and the RBI in this regard and our Company and the investor will be required to comply with applicable reporting requirements.

As specified in 4.1.4.2 (b)(i) and 4.1.4.2 (c)(iv) of the General Information Document, it is hereby clarified that bids received from FPIs bearing the same PAN shall be treated as multiple Bids and are liable to be rejected, except for Bids from FPIs that utilize the multiple investment manager structure in accordance with the Operational Guidelines for Foreign Portfolio Investors and Designated Depository Participants issued to facilitate implementation of SEBI FPI Regulations (“**MIM Structure**”), provided such Bids have been made with different beneficiary account numbers, Client IDs and DP IDs. Accordingly, it should be noted that multiple Bids received from FPIs, who do not utilize the MIM Structure, and bear the same PAN, are liable to be rejected. In order to ensure valid Bids, FPIs making multiple Bids using the same PAN, and with different beneficiary account numbers, Client IDs and DP IDs, are required to provide a confirmation along with each of their Bid cum Application Forms that the relevant FPIs making multiple Bids utilize the MIM Structure and indicate the name of their respective investment managers in such confirmation. In the absence of such confirmation from the relevant FPIs, such multiple Bids are liable to be rejected. Further, in the following cases, the bids by FPIs will not be considered as multiple Bids: involving (i) the MIM Structure and indicating the name of their respective investment managers in such confirmation; (ii) offshore derivative instruments (“**ODI**”) which have obtained separate FPI registration for ODI and proprietary derivative investments; (iii) sub funds or separate class of investors with segregated portfolio who obtain separate FPI registration; (iv) FPI registrations granted at investment strategy level/sub fund level where a collective investment scheme or fund has multiple investment strategies/sub-funds with identifiable differences and managed by a single investment manager; (v) multiple branches in different jurisdictions

of foreign bank registered as FPIs; (vi) Government and Government related investors registered as Category 1 FPIs; and (vii) Entities registered as Collective Investment Scheme having multiple share classes.

With effect from the April 1, 2020, the aggregate limit shall be the sectoral caps applicable to the Indian company as prescribed in the FEMA Rules with respect to its paid-up equity capital on a fully diluted basis. While the aggregate limit as provided above could have been decreased by the concerned Indian companies to a lower threshold limit of 24%, 49% or 74% as deemed fit, with the approval of its board of directors and its shareholders through a resolution and a special resolution, respectively before March 31, 2020, our Company has not decreased such limit and accordingly the applicable limit with respect to our Company is 100%.

FPIs are permitted to participate in the Offer subject to compliance with conditions and restrictions which may be specified by the Government from time to time.

Subject to compliance with all applicable Indian laws, rules, regulations, guidelines and approvals in terms of Regulation 21 of the SEBI FPI Regulations, an FPI, may issue, subscribe to or otherwise deal in offshore derivative instruments (as defined under the SEBI FPI Regulations as any instrument, by whatever name called, which is issued overseas by a FPI against securities held by it in India, as its underlying) directly or indirectly, only in the event (i) such offshore derivative instruments are issued only by persons registered as Category I FPIs; (ii) such offshore derivative instruments are issued only to persons eligible for registration as Category I FPIs; (iii) such offshore derivative instruments are issued after compliance with 'know your client' norms; and (iv) such other conditions as may be specified by SEBI from time to time.

An FPI issuing offshore derivative instruments is also required to ensure that any transfer of offshore derivative instruments issued by or on its behalf, is carried out subject to *inter alia* the following conditions:

- (a) such offshore derivative instruments are transferred only to persons in accordance with Regulation 22(1) of the SEBI FPI Regulations; and
- (b) prior consent of the FPI is obtained for such transfer, except when the persons to whom the offshore derivative instruments are to be transferred to are pre-approved by the FPI.

Participation of FPIs in the Offer shall be subject to the FEMA Rules.

Bids under Power of Attorney

In case of Bids made pursuant to a power of attorney or by limited companies, corporate bodies, registered societies, eligible FPIs, AIFs, Mutual Funds, insurance companies, insurance funds set up by the army, navy or air force of India, insurance funds set up by the Department of Posts, India or the National Investment Fund and provident funds with a minimum corpus of ₹250 million and pension funds with a minimum corpus of ₹250 million (in each case, subject to applicable law and in accordance with their respective constitutional documents), a certified copy of the power of attorney or the relevant resolution or authority, as the case may be, along with a certified copy of the memorandum of association and articles of association and/or bye laws, as applicable must be lodged along with the Bid cum Application Form. Failing this, our Company and the Selling Shareholders reserve the right to accept or reject any Bid in whole or in part, in either case, without assigning any reasons thereof.

Our Company and the Investor Selling Shareholder, in consultation with the Book Running Lead Managers in their absolute discretion, reserve the right to relax the above condition of simultaneous lodging of the power of attorney along with the Bid cum Application Form.

Bids by SEBI registered VCFs, AIFs and FVCIs

The SEBI FVCI Regulations, *inter alia*, prescribe the investment restrictions on VCFs and FVCIs registered with SEBI. Further, the SEBI AIF Regulations prescribe, amongst others, the investment restrictions on AIFs. Accordingly, the holding in any company by any individual VCF or FVCI registered with SEBI should not exceed 25% of the corpus of the VCF or FVCI. Further, subject to FEMA Rules, VCFs and FVCIs can invest only up to 33.33% of their investible funds in various prescribed instruments, including in public offerings.

Category I AIFs and Category II AIFs cannot invest more than 25% of the investible funds in one investee company. A category III AIF cannot invest more than 10% of the investible funds in one investee company. A VCF registered as a Category I AIF, as defined in the SEBI AIF Regulations, cannot invest more than one-third of its investible funds by way of subscription to an initial public offering of a venture capital undertaking. Pursuant to the repeal of the SEBI VCF Regulations, the VCFs which have not re-registered as an AIF under the SEBI AIF Regulations shall continue to be regulated by the SEBI VCF Regulations until the existing fund or scheme managed by the fund is wound up and such fund shall not launch any new scheme after the notification of the SEBI AIF Regulations. Our Company, the Selling Shareholders, the Book Running Lead Managers will not be responsible for loss, if any, incurred by the Bidder on account of conversion of foreign currency.

Participation of VCFs, AIFs or FVCIs in the Offer shall be subject to the FEMA Rules.

All non-resident investors should note that refunds (in case of Anchor Investors), dividends and other distributions, if any, will be payable in Indian Rupees only and net of bank charges and commission.

Bids by Limited Liability Partnerships

In case of Bids made by limited liability partnerships registered under the Limited Liability Partnership Act, 2008, a certified copy of certificate of registration issued under the Limited Liability Partnership Act, 2008, must be attached to the Bid cum Application Form. Failing this, our Company and the Investor Selling Shareholder, in consultation with the Book Running Lead Managers, reserve the right to reject any Bid without assigning any reason thereof.

Bids by Banking Companies

In case of Bids made by banking companies registered with the RBI, certified copies of (i) the certificate of registration issued by the RBI, and (ii) the approval of such banking company's investment committee are required to be attached to the Bid cum Application Form. Failing this, our Company and the Investor Selling Shareholder, in consultation with the Book Running Lead Managers, reserve the right to reject any Bid without assigning any reason thereof, subject to applicable law.

The investment limit for banking companies in non-financial services companies as per the Banking Regulation Act, 1949, as amended, (the "**Banking Regulation Act**"), and the Master Directions - Reserve Bank of India (Financial Services provided by Banks) Directions, 2016, as amended, is 10% of the paid-up share capital of the investee company, not being its subsidiary engaged in non-financial services, or 10% of the bank's own paid-up share capital and reserves, whichever is lower. Further, the aggregate investment by a banking company in subsidiaries and other entities engaged in financial services company cannot exceed 20% of the investee company's paid up share capital and reserves. However, a banking company would be permitted to invest in excess of 10% but not exceeding 30% of the paid-up share capital of such investee company if (i) the investee company is engaged in non-financial activities permitted for banks in terms of Section 6(1) of the Banking Regulation Act, or (ii) the additional acquisition is through restructuring of debt/corporate debt restructuring/strategic debt restructuring, or to protect the bank's interest on loans/investments made to a company. The bank is required to submit a time-bound action plan for disposal of such shares within a specified period to the RBI. A banking company would require a prior approval of the RBI to make (i) investment in excess of 30% of the paid-up share capital of the investee company, (ii) investment in a subsidiary and a financial services company that is not a subsidiary (with certain exceptions prescribed), and (iii) investment in a non-financial services company in excess of 10% of such investee company's paid-up share capital as stated in 5(a)(v)(c)(i) of the Reserve Bank of India (Financial Services provided by Banks) Directions, 2016, as amended.

Bids by SCSBs

SCSBs participating in the Offer are required to comply with the terms of the circulars bearing numbers CIR/CFD/DIL/12/2012 and CIR/CFD/DIL/1/2013 dated September 13, 2012 and January 2, 2013, respectively, issued by SEBI. Such SCSBs are required to ensure that for making applications on their own account using ASBA, they should have a separate account in their own name with any other SEBI registered SCSBs. Further, such account shall be used solely for the purpose of making application in public issues and clear demarcated funds should be available in such account for such applications.

Bids by Insurance Companies

In case of Bids made by insurance companies registered with the IRDAI, a certified copy of certificate of registration issued by IRDAI must be attached to the Bid cum Application Form. Failing this, our Company and the Investor Selling Shareholder, in consultation with the Book Running Lead Managers, reserve the right to reject any Bid without assigning any reason thereof, subject to applicable law.

The exposure norms for insurers are prescribed under the Insurance Regulatory and Development Authority of India (Investment) Regulations, 2016, as amended ("**IRDAI Investment Regulations**"), based on investments in the equity shares of a company, the entire group of the investee company and the industry sector in which the investee company operates. Insurance companies participating in the Offer are advised to refer to the IRDAI Investment Regulations for specific investment limits applicable to them and shall comply with all applicable regulations, guidelines and circulars issued by IRDAI from time to time.

Bids by Provident Funds/Pension Funds

In case of Bids made by provident funds/pension funds with minimum corpus of ₹250 million, subject to applicable law, a certified copy of a certificate from a chartered accountant certifying the corpus of the provident fund/pension fund must be attached to the Bid cum Application Form. Failing this, our Company and the Investor Selling Shareholder, in consultation with the Book Running Lead Managers, reserve the right to reject any Bid, without assigning any reason thereof.

Bids by Systemically Important Non-Banking Financial Companies

In case of Bids made by Systemically Important Non-Banking Financial Companies registered with RBI, certified copies of: (i) the certificate of registration issued by RBI, (ii) certified copy of its last audited financial statements on a standalone basis, (iii) a net worth certificate from its statutory auditor, and (iv) such other approval as may be required by the Systemically Important Non-Banking Financial Companies, are required to be attached to the Bid cum Application Form. Failing this, our Company and the Investor Selling Shareholder, in consultation with the Book Running Lead Managers, reserves the right to reject any Bid without assigning any reason thereof, subject to applicable law. Systemically Important NBFCs participating in the Offer shall comply with all applicable regulations, guidelines and circulars issued by RBI from time to time.

The investment limit for Systemically Important NBFCs shall be as prescribed by RBI from time to time.

Bids by Eligible Employees

The Bid must be for a minimum of [●] Equity Shares and in multiples of [●] Equity Shares thereafter so as to ensure that the Bid Amount payable by the Eligible Employee does not exceed ₹0.50 million (net of Employee Discount). However, the initial allocation to an Eligible Employee in the Employee Reservation Portion shall not exceed ₹0.20 million. Allotment in the Employee Reservation Portion will be as detailed in the section “*Offer Structure*” beginning on page 433.

However, Allotments to Eligible Employees in excess of ₹0.20 million shall be considered on a proportionate basis, in the event of undersubscription in the Employee Reservation Portion, subject to the total Allotment to an Eligible Employee not exceeding ₹0.50 million (net of Employee Discount). Subsequent undersubscription, if any, in the Employee Reservation Portion shall be added back to the Net Offer. Eligible Employees Bidding in the Employee Reservation Portion may Bid at the Cut-off Price.

Bids under the Employee Reservation Portion by Eligible Employees shall be:

1. Made only in the prescribed Bid cum Application Form or Revision Form.
2. Only Eligible Employees (excluding such other persons not eligible under applicable laws, rules, regulations and guidelines) would be eligible to apply in this Offer under the Employee Reservation Portion.
3. In case of joint bids, the sole/ First Bidder shall be the Eligible Employee.
4. Bids by Eligible Employees may be made at Cut-off Price.
5. Only those Bids, which are received at or above the Offer Price, net of Employee Discount, would be considered for allocation under this portion.
6. The Bids must be for a minimum of [●] Equity Shares and in multiples of [●] Equity Shares thereafter so as to ensure that the Bid Amount payable by the Eligible Employee subject to a maximum Bid Amount of ₹0.50 million (net of Employee Discount).
7. If the aggregate demand in this portion is less than or equal to [●] Equity Shares at or above the Offer Price, full allocation shall be made to the Eligible Employees to the extent of their demand.
8. Bids by Eligible Employees in the Employee Reservation Portion and in the Net Offer portion shall not be treated as multiple Bids. Our Company reserves the right to reject, in its absolute discretion, all or any multiple Bids in any or all categories.
9. As per the SEBI circular SEBI/HO/CFD/DIL2/CIR/P/2022/45 dated April 5, 2022, Eligible Employees bidding in the Employee Reservation Portion can Bid through the UPI mechanism.

In the event of under-subscription in the Employee Reservation Portion, the unsubscribed portion will be available for allocation and Allotment, proportionately to all Eligible Employees who have Bid in excess of ₹0.20 million, subject to the maximum value of Allotment made to such Eligible Employee not exceeding ₹0.50 million (net of Employee Discount).

If the aggregate demand in this portion is greater than [●] Equity Shares at or above the Offer Price, the allocation shall be made on a proportionate basis. For the method of proportionate basis of Allotment, see “*Offer Procedure*” beginning on page 436.

Bids by Anchor Investors

In accordance with the SEBI ICDR Regulations, in addition to details and conditions mentioned in this section, the key terms for participation by Anchor Investors are provided below.

- 1) Anchor Investor Application Forms will be made available for the Anchor Investor Portion at the offices of the Book Running Lead Managers.
- 2) The Bid must be for a minimum of such number of Equity Shares so that the Bid Amount exceeds ₹100 million. A Bid cannot be submitted for over 60% of the QIB Portion. In case of a Mutual Fund, separate Bids by individual schemes of a Mutual Fund will be aggregated to determine the minimum application size of ₹100 million.
- 3) One-third of the Anchor Investor Portion will be reserved for allocation to domestic Mutual Funds.
- 4) Bidding for Anchor Investors will open one Working Day before the Bid/ Offer Opening Date, and will be completed on the same day.
- 5) Our Company and the Investor Selling Shareholder, in consultation with the the Book Running Lead Managers will finalize allocation to the Anchor Investors on a discretionary basis, provided that the minimum number of Allottees in the Anchor Investor Portion will not be less than: (a) maximum of two Anchor Investors, where allocation under the

Anchor Investor Portion is up to ₹100 million; (b) minimum of two and maximum of 15 Anchor Investors, where the allocation under the Anchor Investor Portion is more than ₹100 million but up to ₹2,500 million, subject to a minimum Allotment of ₹50 million per Anchor Investor; and (c) in case of allocation above ₹2,500 million under the Anchor Investor Portion, a minimum of five such investors and a maximum of 15 Anchor Investors for allocation up to ₹2,500 million, and an additional 10 Anchor Investors for every additional ₹2,500 million, subject to minimum Allotment of ₹50 million per Anchor Investor.

- 6) Allocation to Anchor Investors will be completed on the Anchor Investor Bidding Date. The number of Equity Shares allocated to Anchor Investors and the price at which the allocation is made, will be made available in the public domain by the Book Running Lead Managers before the Bid/ Offer Opening Date, through intimation to the Stock Exchanges.
- 7) Anchor Investors cannot withdraw or lower the size of their Bids at any stage after submission of the Bid.
- 8) If the Offer Price is greater than the Anchor Investor Allocation Price, the additional amount being the difference between the Offer Price and the Anchor Investor Allocation Price will be payable by the Anchor Investors on the Anchor Investor Pay-in Date specified in the CAN. If the Offer Price is lower than the Anchor Investor Allocation Price, Allotment to successful Anchor Investors will be at the higher price, i.e., the Anchor Investor Offer Price.
- 9) The Equity Shares Allotted in the Anchor Investor Portion will be locked in, in accordance with the SEBI ICDR Regulations. 50% Equity Shares allotted to Anchor Investors shall be locked-in for a period of 90 days from the date of Allotment, whereas, the remaining 50% shall be locked-in for a period of 30 days from the date of Allotment.
- 10) Neither the (a) Book Running Lead Managers (s) or any associate of the Book Running Lead Managers (other than mutual funds sponsored by entities which are associate of the Book Running Lead Managers or insurance companies promoted by entities which are associate of the Book Running Lead Managers or Alternate Investment Funds (AIFs) sponsored by the entities which are associates of the Book Running Lead Managers or FPIs, other than individuals, corporate bodies and family offices, sponsored by the entities which are associate of the Book Running Lead Managers) nor (b) the Promoters, Promoter Group or any person related to the Promoters or members of the Promoter Group shall apply under the Anchor Investors category.
- 11) Bids made by QIBs under both the Anchor Investor Portion and the QIB Portion will not be considered multiple Bids.

For more information, please read the General Information Document.

The information set out above is given for the benefit of the Bidders. Our Company, the Selling Shareholders, the Book Running Lead Managers are not liable for any amendments or modification or changes to applicable laws or regulations, which may occur after the date of this Red Herring Prospectus. Bidders are advised to make their independent investigations and ensure that any single Bid from them does not exceed the applicable investment limits or maximum number of the Equity Shares that can be held by them under applicable law or regulations, or as will be specified in this Red Herring Prospectus.

General Instructions

Please note that QIBs and Non-Institutional Bidders are not permitted to withdraw their Bid(s) or lower the size of their Bid(s) (in terms of quantity of Equity Shares or the Bid Amount) at any stage. RIBs can revise their Bid(s) during the Bid/Offer Period and withdraw or lower the size of their Bid(s) until Bid/Offer Closing Date. Anchor Investors are not allowed to withdraw their Bids after the Anchor Investor Bid/Offer Period.

Do's:

1. Check if you are eligible to apply as per the terms of this Red Herring Prospectus and under applicable law, rules, regulations, guidelines and approvals;
2. All Bidders (other than Anchor Investors) should submit their Bids through the ASBA process only;
3. Ensure that you have Bid within the Price Band;
4. Read all the instructions carefully and complete the Bid cum Application Form in the prescribed form;
5. Ensure that you (other than the Anchor Investors) have mentioned the correct details of ASBA Account (i.e. bank account number or UPI ID, as applicable) in the Bid cum Application Form if you are not a UPI Bidder in the Bid cum Application Form and if you are a UPI Bidder ensure that you have mentioned the correct UPI ID (with maximum length of 45 characters including the handle), in the Bid cum Application Form;
6. Ensure that your Bid cum Application Form bearing the stamp of a Designated Intermediary is submitted to the Designated Intermediary at the relevant Bidding Centre (except in case of electronic Bids) within the prescribed time. Bidders (other than Anchor Investors) shall submit the Bid cum Application Form in the manner set out in the General Information Document;

7. UPI Bidders Bidding in the Offer shall ensure that they use only their own ASBA Account or only their own bank account linked UPI ID to make an application in the Offer and not ASBA Account or bank account linked UPI ID of any third party
8. UPI Bidders not using the UPI Mechanism, should submit their Bid cum Application Form directly with SCSBs and/or the designated branches of SCSBs;
9. Ensure that you mandatorily have funds equal to the Bid Amount in the ASBA Account maintained with the SCSB before submitting the ASBA Form to the relevant Designated Intermediaries;
10. Ensure that the signature of the first Bidder in case of joint Bids, is included in the Bid cum Application Forms. If the first Bidder is not the ASBA Account holder, ensure that the Bid cum Application Form is also signed by the ASBA Account holder;
11. Ensure that the names given in the Bid cum Application Form is/are exactly the same as the names in which the beneficiary account is held with the Depository Participant. In case of joint Bids, the Bid cum Application Form should contain the name of only the first Bidder whose name should also appear as the first holder of the beneficiary account held in joint names;
12. Ensure that you request for and receive a stamped acknowledgement in the form of a counterfoil or acknowledgment specifying the application number as a proof of having accepted the Bid cum Application Form for all your Bid options from the concerned Designated Intermediary;
13. Ensure that you submit the revised Bids to the same Designated Intermediary, through whom the original Bid was placed and obtain a revised acknowledgment.
14. Except for Bids (i) on behalf of the Central or State Governments and the officials appointed by the courts, who, in terms of the circular no. MRD/DoP/Cir-20/2008 dated June 30, 2008 issued by SEBI, may be exempt from specifying their PAN for transacting in the securities market, (ii) Bids by persons resident in the state of Sikkim, who, in terms of the circular dated July 20, 2006 issued by SEBI, may be exempted from specifying their PAN for transacting in the securities market, and (iii) persons/entities exempt from holding a PAN under applicable law, all Bidders should mention their PAN allotted under the IT Act. The exemption for the Central or the State Government and officials appointed by the courts and for investors residing in the State of Sikkim is subject to (a) the Demographic Details received from the respective depositories confirming the exemption granted to the beneficial owner by a suitable description in the PAN field and the beneficiary account remaining in "active status"; and (b) in the case of residents of Sikkim, the address as per the Demographic Details evidencing the same. All other applications in which PAN is not mentioned will be rejected;
15. Ensure that thumb impressions and signatures other than in the languages specified in the Eighth Schedule to the Constitution of India are attested by a Magistrate or a Notary Public or a Special Executive Magistrate under official seal;
16. Ensure that the category and the investor status is indicated in the Bid cum Application Form to ensure proper upload of your Bid in the electronic Bidding system of the Stock Exchanges;
17. Ensure that in case of Bids under power of attorney or by limited companies, corporates, trust, etc., relevant documents including a copy of the power of attorney, if applicable, are submitted;
18. Ensure that Bids submitted by any person outside India is in compliance with applicable foreign and Indian laws;
19. However, Bids received from FPIs bearing the same PAN shall not be treated as multiple Bids in the event such FPIs utilise the MIM Structure and such Bids have been made with different beneficiary account numbers, Client IDs and DP IDs.
20. FPIs making MIM Bids using the same PAN, and different beneficiary account numbers, Client IDs and DP IDs, are required to submit a confirmation that their Bids are under the MIM structure and indicate the name of their investment managers in such confirmation which shall be submitted along with each of their Bid cum Application Forms. In the absence of such confirmation from the relevant FPIs, such MIM Bids shall be rejected;
21. Since the Allotment will be in dematerialised form only, ensure that the depository account is active, the correct DP ID, Client ID, UPI ID (for UPI Bidders Bidding through UPI mechanism) and the PAN are mentioned in their Bid cum Application Form and that the name of the Bidder, the DP ID, Client ID, UPI ID (for UPI Bidders Bidding through UPI mechanism) and the PAN entered into the online IPO system of the Stock Exchanges by the relevant Designated Intermediary, as applicable, matches with the name, DP ID, Client ID, UPI ID (for UPI Bidders Bidding through UPI mechanism) and PAN available in the Depository database;
22. In case of QIBs and NIIs, ensure that while Bidding through a Designated Intermediary, the ASBA Form is submitted to a Designated Intermediary in a Bidding Centre and that the SCSB where the ASBA Account, as specified in the

ASBA Form, is maintained has named at least one branch at that location for the Designated Intermediary to deposit ASBA Forms (a list of such branches is available on the website of SEBI at <http://www.sebi.gov.in>);

23. Ensure that you have correctly signed the authorisation / undertaking box in the Bid cum Application Form, or have otherwise provided an authorisation to the SCSB or the Sponsor Banks, as applicable, via the electronic mode, for blocking funds in the ASBA Account equivalent to the Bid Amount mentioned in the Bid cum Application Form at the time of submission of the Bid. In case of UPI Bidders submitting their Bids and participating in the Offer through the UPI Mechanism, ensure that you authorise the UPI Mandate Request, including in case of any revision of Bids, raised by the Sponsor Banks for blocking of funds equivalent to Bid Amount and subsequent debit of funds in case of Allotment;
24. Ensure that the Demographic Details are updated, true and correct in all respects;
25. The ASBA Bidders shall use only their own bank account or only their own bank account linked UPI ID for the purposes of making Application in the Offer, which is UPI 2.0 certified by NPCI;
26. Bidders (except UPI Bidders) should instruct their respective banks to release the funds blocked in the ASBA account under the ASBA process. In case of RIBs, once the Sponsor Banks issues the Mandate Request, the RIBs would be required to proceed to authorize the blocking of funds by confirming or accepting the UPI Mandate Request to authorize the blocking of funds equivalent to application amount and subsequent debit of funds in case of Allotment, in a timely manner;
27. Bidding through UPI Mechanism shall ensure that details of the Bid are reviewed and verified by opening the attachment in the UPI Mandate Request and then proceed to authorize the UPI Mandate Request using his/her UPI pin. Upon the authorization of the mandate using his/her UPI pin, a UPI Bidder Bidding through UPI Mechanism shall be deemed to have verified the attachment containing the application details of the RIB Bidding through UPI Mechanism in the UPI Mandate Request and have agreed to block the entire Bid Amount and authorized the Sponsor Banks issue a request to block the Bid Amount specified in the Bid cum Application Form in his/her ASBA Account;
28. UPI Bidders should mention valid UPI ID of only the Bidder (in case of single account) and of the first Bidder (in case of joint account) in the Bid cum Application Form;
29. UPI Bidders who have revised their Bids subsequent to making the initial Bid should also approve the revised UPI Mandate Request generated by the Sponsor Banks to authorize blocking of funds equivalent to the revised Bid Amount and subsequent debit of funds in case of Allotment in a timely manner;
30. Bids by Eligible NRIs for a Bid Amount of less than ₹0.20 million would be considered under the Retail Category for the purposes of allocation and Bids for a Bid Amount exceeding ₹0.20 million would be considered under the Non-Institutional Category for allocation in the Offer;
31. UPI Bidders using UPI Mechanism through the SCSBs and mobile applications shall ensure that the name of the bank appears in the list of SCSBs which are live on UPI, as displayed on the SEBI website. RIBs shall ensure that the name of the app and the UPI handle which is used for making the application appears in Annexure 'A' to the SEBI circular no. SEBI/HO/CFD/DIL2/COR/P/2019/85 dated July 26, 2019; and
32. Ensure that you have accepted the UPI Mandate Request received from the Sponsor Banks prior to 12:00 p.m. of the Working Day immediately after the Bid/ Offer Closing Date.
33. The ASBA bidders shall ensure that bids above ₹0.50 million, are uploaded only by the SCSBs.

The Bid cum Application Form is liable to be rejected if the above instructions, as applicable, are not complied with. Application made using incorrect UPI handle or using a bank account of an SCSB or SCSBs which is not mentioned in the Annexure 'A' to the SEBI circular no. SEBI/HO/CFD/DIL2/CIR/P/2019/85 dated July 26, 2019 is liable to be rejected.

Don'ts:

1. Do not Bid for lower than the minimum Bid Lot;
2. Do not submit a Bid using UPI ID, if you are not a UPI Bidder;
3. Do not Bid for a Bid Amount exceeding ₹0.20 million (for Bids by RIBs) and ₹0.50 million for Bids by Eligible Employees Bidding in the Employee Reservation Portion;
4. Do not Bid on another Bid cum Application Form and the Anchor Investor Application Form, as the case may be, after you have submitted a Bid to any of the Designated Intermediary;
5. Do not Bid/ revise the Bid amount to less than the Floor Price or higher than the Cap Price;

6. Do not pay the Bid Amount in cheques, demand drafts or by cash, money order, postal order or by stock invest;
7. Do not send Bid cum Application Forms by post; instead submit the same to the Designated Intermediary only;
8. Do not Bid at Cut-off Price (for Bids by QIBs and Non-Institutional Bidders);
9. Do not instruct your respective banks to release the funds blocked in the ASBA Account under the ASBA process;
10. Do not submit the Bid for an amount more than funds available in your ASBA account;
11. Do not submit Bids on plain paper or on incomplete or illegible Bid cum Application Forms or on Bid cum Application Forms in a colour prescribed for another category of Bidder;
12. Do not submit a Bid in case you are not eligible to acquire Equity Shares under applicable law or your relevant constitutional documents or otherwise;
13. Do not Bid if you are not competent to contract under the Indian Contract Act, 1872 (other than minors having valid depository accounts as per Demographic Details provided by the depository);
14. Do not fill up the Bid cum Application Form such that the Equity Shares Bid for exceeds the Offer size and / or investment limit or maximum number of the Equity Shares that can be held under the applicable laws or regulations or maximum amount permissible under the applicable regulations or under the terms of the Red Herring Prospectus;
15. Do not Bid for Equity Shares more than specified by respective Stock Exchanges for each category;
16. In case of ASBA Bidders (other than UPI Bidders using UPI mechanism), do not submit more than one Bid cum Application Form per ASBA Account;
17. Do not make the Bid cum Application Form using third party bank account or using third party linked bank account UPI ID;
18. Anchor Investors should not bid through the ASBA process;
19. Do not submit the Bid cum Application Form to any non-SCSB bank or our Company;
20. Do not Bid on another Bid cum Application Form and the Anchor Investor Application Form, as the case may be, after you have submitted a Bid to any of the Designated Intermediaries;
21. Do not submit the GIR number instead of the PAN;
22. Anchor Investors should submit Anchor Investor Application Form only to the Book Running Lead Managers;
23. Do not Bid on a Bid cum Application Form that does not have the stamp of a Designated Intermediary;
24. If you are a QIB, do not submit your Bid after 3 p.m. on the QIB Bid / Offer Closing Date;
25. Do not withdraw your Bid or lower the size of your Bid (in terms of quantity of the Equity Shares or the Bid Amount) at any stage, if you are a QIB or a Non-Institutional Bidder. Retail Individual Bidders or Eligible Employees Bidding in the Employee Reservation Portion can revise or withdraw their Bids on or before the Bid/Offer Closing Date;
26. Do not submit Bids to a Designated Intermediary at a location other than at the relevant Bidding Centres. If you are a UPI Bidder and are using UPI mechanism, do not submit the ASBA Form directly with SCSBs;
27. Do not submit the ASBA Forms to any Designated Intermediary that is not authorised to collect the relevant ASBA Forms or to our Company;
28. Do not submit incorrect details of the DP ID, Client ID, PAN and UPI ID details if you are a UPI Bidder. Further, do not provide details for a beneficiary account which is suspended or for which details cannot be verified to the Registrar to the Offer;
29. Do not submit the Bid without ensuring that funds equivalent to the entire Bid Amount are available for blocking in the relevant ASBA account;
30. Do not link the UPI ID with a bank account maintained with a bank that is not UPI 2.0 certified by the NPCI in case of Bids submitted by UPI Bidders using the UPI Mechanism;
31. Do not Bid if you are an OCB;

32. UPI Bidders using the incorrect UPI handle or using a bank account of an SCSB or a bank which is not mentioned in the list provided in the SEBI website is liable to be rejected; and
33. Do not submit more than one Bid cum Application Form for each UPI ID in case of UPI Bidders.
34. In case of ASBA Bidders (other than 3 in 1 Bids) Syndicate Members shall ensure that they do not upload any bids above ₹0.50 million;

The Bid cum Application Form is liable to be rejected if the above instructions, as applicable, are not complied with.

Grounds for Technical Rejection

In addition to the grounds for rejection of Bids on technical grounds as provided in the GID, Bidders are requested to note that Bids may be rejected on the following additional technical grounds:

1. Bids submitted without instruction to the SCSBs to block the entire Bid Amount;
2. Bids which do not contain details of the Bid Amount and the bank account details in the ASBA Form;
3. Bids submitted on a plain paper;
4. Bids submitted by UPI Bidders using the UPI Mechanism through an SCSBs and/or using a mobile application or UPI handle, not listed on the website of SEBI;
5. Bids under the UPI Mechanism submitted by UPI Bidders using third party bank accounts or using a third party linked bank account UPI ID (subject to availability of information regarding third party account from Sponsor Banks);
6. ASBA Form submitted to a Designated Intermediary does not bear the stamp of the Designated Intermediary;
7. Bids submitted without the signature of the First Bidder or sole Bidder;
8. The ASBA Form not being signed by the account holders, if the account holder is different from the Bidder;
9. ASBA Form by the RIBs by using third party bank accounts or using third party linked bank account UPI IDs;
10. Bids by persons for whom PAN details have not been verified and whose beneficiary accounts are “suspended for credit” in terms of SEBI circular CIR/MRD/DP/22/2010 dated July 29, 2010;
11. GIR number furnished instead of PAN;
12. Bids by RIBs with Bid Amount of a value of more than ₹0.20 million;
13. Bids by persons who are not eligible to acquire Equity Shares in terms of all applicable laws, rules, regulations, guidelines and approvals;
14. Bids accompanied by stock invest, money order, postal order or cash; and
15. Bids uploaded by QIBs after 4.00 pm on the QIB Bid/ Offer Closing Date and by Non-Institutional Bidders uploaded after 4.00 p.m. on the Bid/ Offer Closing Date, and Bids by RIBs uploaded after 5.00 p.m. on the Bid/ Offer Closing Date, unless extended by the Stock Exchanges. On the Bid/Offer Closing Date, extension of time may be granted by the Stock Exchanges only for uploading Bids received from Retail Individual Bidders, after taking into account the total number of Bids received up to closure of timings for acceptance of Bid-cum-Application Forms as stated herein and as informed to the Stock Exchanges.

Further, in case of any pre-issue or post issue related issues regarding share certificates/demat credit/refund orders/unblocking etc., investors shall reach out to the Company Secretary and Compliance officer. For details of the Company Secretary and Compliance officer, see “*General Information*” beginning on page 73.

In case of any delay in unblocking of amounts in the ASBA Accounts (including amounts blocked through the UPI Mechanism) exceeding four Working Days from the Bid/Offer Closing Date, the Bidder shall be compensated at a uniform rate of ₹100 per day or 15% per annum of the Bid Amount for the entire duration of delay exceeding four Working Days from the Bid/Offer Closing Date by the intermediary responsible for causing such delay in unblocking. The Book Running Lead Managers shall, in their sole discretion, identify and fix the liability on such intermediary or entity responsible for such delay in unblocking.

For details of grounds for technical rejections of a Bid cum Application Form, please see the General Information Document.

Names of entities responsible for finalising the basis of allotment in a fair and proper manner

The authorised employees of the Stock Exchanges, along with the Book Running Lead Managers and the Registrar, shall ensure that the Basis of Allotment is finalised in a fair and proper manner in accordance with the procedure specified in SEBI ICDR Regulations.

Method of allotment as may be prescribed by SEBI from time to time

Our Company will not make any allotment in excess of the Equity Shares offered through this Offer document.

The allotment of Equity Shares to applicants other than to the RIBs, NIIs and Anchor Investors shall be on a proportionate basis within the respective investor categories and the number of securities allotted shall be rounded off to the nearest integer, subject to minimum allotment being equal to the minimum application size as determined and disclosed.

The allotment of Equity Shares to each Retail Individual Bidders shall not be less than the minimum bid lot, subject to the availability of shares in Retail Individual Bidders Portion and the remaining available shares, if any, shall be allotted on a proportionate basis. Further, not less than 15% of the Net Offer shall be available for allocation to Non-Institutional Bidders of which one-third portion shall be available for allocation to Non- Institutional Bidders with a Bid size of more than ₹0.20 million and up to ₹1.00 million and two-third portion shall be available for allocation to Non-Institutional Bidders with an application size of more than ₹1.00 million in accordance with the SEBI ICDR Regulations. Provided that the unsubscribed portion in either of the aforementioned sub-categories may be allocated to applicants in the other sub-category of Non-Institutional Bidders. Further, the allocation to each Non-Institutional Investor shall not be less than Minimum NIB Application Size, subject to availability of Equity Shares in the Non-Institutional Portion and the remaining available Equity Shares, if any, shall be allocated on a proportionate basis.

Payment into Anchor Investor Escrow Accounts

Our Company and the Investor Selling Shareholder, in consultation with the Book Running Lead Managers will decide the list of Anchor Investors to whom the CAN will be sent, pursuant to which, the details of the Equity Shares allocated to them in their respective names will be notified to such Anchor Investors. For Anchor Investors, the payment instruments for payment into the Anchor Investor Escrow Account should be drawn in favour of:

- (a) In case of resident Anchor Investors: **“R R KABEL LIMITED – ANCHOR INVESTOR - R”**
- (b) In case of Non-Resident Anchor Investors: **“R R KABEL LIMITED – ANCHOR INVESTOR - NR”**

Anchor Investors should note that the escrow mechanism is not prescribed by SEBI and has been established as an arrangement between our Company, the Selling Shareholders, the Syndicate, the Escrow Collection Bank and the Registrar to the Offer to facilitate collections of Bid amounts from Anchor Investors.

Pre-Offer Advertisement

Subject to Section 30 of the Companies Act, our Company shall, after filing the Red Herring Prospectus with the RoC, publish a pre-Offer advertisement, in the form prescribed under the SEBI ICDR Regulations, in all editions of English national daily newspaper, The Financial Express, all editions of Hindi national daily newspaper, Jansatta, and the Mumbai edition of the Marathi daily newspaper, Navshakti (Marathi being the regional language of Maharashtra where our Registered Office is located) each with wide circulation.

In the pre-Offer advertisement, we shall state the Bid/Offer Opening Date and the Bid/Offer Closing Date. This advertisement, subject to the provisions of Section 30 of the Companies Act, shall be in the format prescribed in Part A of Schedule X of the SEBI ICDR Regulations.

Allotment Advertisement

Our Company, the Book Running Lead Managers and the Registrar shall publish an allotment advertisement before commencement of trading, disclosing the date of commencement of trading in all editions of English national daily newspaper, The Financial Express, all editions of Hindi national daily newspaper, Jansatta, and the Mumbai edition of the Marathi daily newspaper, Navshakti (Marathi being the regional language of Maharashtra, where our Registered Office is located) each with wide circulation.

The information set out above is given for the benefit of the Bidders/applicants. Our Company, the Selling Shareholders, the Book Running Lead Managers are not liable for any amendments or modification or changes in applicable laws or regulations, which may occur after the date of this Red Herring Prospectus. Bidders/applicants are advised to make their independent investigations and ensure that the number of Equity Shares Bid for do not exceed the prescribed limits under applicable laws or regulations.

Signing of the Underwriting Agreement and Filing with the RoC

- a) Our Company, the Selling Shareholders and the Underwriters intend to enter into an Underwriting Agreement after the finalisation of the Offer Price.
- b) After signing the Underwriting Agreement, an updated Red Herring Prospectus will be filed with the RoC in accordance with applicable law, which would then be termed as the Prospectus. The Prospectus will contain details of the Offer Price, the Anchor Investor Offer Price, the Offer size, and underwriting arrangements and will be complete in all material respects.

Impersonation

Attention of the applicants is specifically drawn to the provisions of sub-section (1) of Section 38 of the Companies Act, which is reproduced below:

“Any person who:

- a) *makes or abets making of an application in a fictitious name to a company for acquiring, or subscribing for, its securities; or*
- b) *makes or abets making of multiple applications to a company in different names or in different combinations of his name or surname for acquiring or subscribing for its securities; or*
- c) *otherwise induces directly or indirectly a company to allot, or register any transfer of, securities to him, or to any other person in a fictitious name,*

shall be liable for action under Section 447.”

The liability prescribed under Section 447 of the Companies Act, for fraud involving an amount of at least ₹1 million or 1% of the turnover of the Company, whichever is lower, includes imprisonment for a term which shall not be less than six months extending up to 10 years and fine of an amount not less than the amount involved in the fraud, extending up to three times such amount (provided that where the fraud involves public interest, such term shall not be less than three years.) Further, where the fraud involves an amount less than ₹1 million or one per cent of the turnover of the company, whichever is lower, and does not involve public interest, any person guilty of such fraud shall be punishable with imprisonment for a term which may extend to five years or with fine which may extend to ₹5 million or with both.

Undertakings by our Company

Our Company undertakes the following:

- the complaints received in respect of the Offer shall be attended to by our Company expeditiously and satisfactorily;
- all steps for completion of the necessary formalities for listing and commencement of trading at all the Stock Exchanges where the Equity Shares are proposed to be listed are taken within six Working Days of the Bid/Offer Closing Date or within such other time period prescribed by SEBI will be taken;
- the funds required for making refunds/unblocking (to the extent applicable) as per the mode(s) disclosed shall be made available to the Registrar to the Offer by our Company;
- if Allotment is not made within the prescribed timelines under applicable laws, the entire subscription amount received will be refunded/unblocked within the time prescribed under applicable laws. If there is a delay beyond such prescribed time, our Company shall pay interest prescribed under the Companies Act, the SEBI ICDR Regulations and other applicable laws for the delayed period;
- where refunds (to the extent applicable) are made through electronic transfer of funds, a suitable communication shall be sent to the Applicant within time prescribed under applicable laws, giving details of the bank where refunds shall be credited along with amount and expected date of electronic credit of refund;
- the Promoter’s contribution, if any, shall be brought in advance before the Bid/Offer Opening Date, in accordance with the applicable provisions of the SEBI ICDR Regulations;
- that if our Company does not proceed with the Offer after the Bid/Offer Closing Date but prior to Allotment, the reason thereof shall be given as a public notice within two days of the Bid/Offer Closing Date. The public notice shall be issued in the same newspapers where the pre-Offer advertisements were published. The Stock Exchanges shall be informed promptly;
- that if the Offer is withdrawn after the Bid/Offer Closing Date, our Company shall be required to file a fresh offer document with SEBI, in the event a decision is taken to proceed with the Offer subsequently; and

- no further issue of the Equity Shares shall be made till the Equity Shares offered through this Red Herring Prospectus are listed or until the Bid monies are refunded/unblocked in the relevant ASBA Accounts on account of non-listing, under-subscription, etc.

Undertakings by the Selling Shareholders

The Selling Shareholders, severally and not jointly, undertake, in relation to itself and its portion of the Offered Shares that:

- the Offered Shares are eligible for being offered in the Offer for Sale in terms of Regulation 8 of the SEBI ICDR Regulations;
- it is the legal and beneficial owner of the Offered Shares, and that the Offered Shares shall be transferred in the Offer, free from encumbrances;
- it shall not offer any incentive, whether direct or indirect, in any manner, whether in cash or kind or services or otherwise to any person (whether related to itself or not) for making a Bid in the Offer, and
- it shall not have recourse to its proceeds of the Offer for Sale until final approval for trading of the Equity Shares from the Stock Exchanges has been received;
- that it shall deposit its Equity Shares offered for sale in the Offer in an escrow demat in accordance with the share escrow agreement to be executed between the parties to such share escrow agreement; and
- that it shall provide assistance to our Company and the BRLMs in redressal of such investor grievances that pertain to its respective portion of the Offered Shares.

The statements and undertakings provided above, in relation to the Selling Shareholders, are statements which are specifically confirmed or undertaken by the Selling Shareholders in relation to themselves and their respective portion of Offered Shares. All other statements or undertakings or both in this Red Herring Prospectus in relation to the Selling Shareholders, shall be statements made by our Company, even if the same relate to the Selling Shareholders.

Utilisation of Offer Proceeds

All the monies received out of the Offer shall be credited / transferred to a separate bank account other than the bank account referred to in sub-section (3) of Section 40 of the Companies Act.

RESTRICTIONS ON FOREIGN OWNERSHIP OF INDIAN SECURITIES

Foreign investment in Indian securities is regulated through the Industrial Policy, 1991 of the Government of India and FEMA. While the Industrial Policy, 1991 prescribes the limits and the conditions subject to which foreign investment can be made in different sectors of the Indian economy, FEMA regulates the precise manner in which such investment may be made. The government bodies responsible for granting foreign investment approvals under the Consolidated FDI Policy and FEMA are the concerned ministries or departments of the Government of India and the RBI.

The Government has, from time to time, made policy pronouncements on FDI through press notes and press releases. The DPIIT, issued the Consolidated FDI Policy by way of circular bearing number DPIIT File Number 5(2)/2020-FDI Policy dated October 15, 2020 (“**Consolidated FDI Policy**”), which with effect from October 15, 2020, consolidates and supersedes all previous press notes, press releases and clarifications on FDI issued by the DPIIT that were in force and effect as on October 15, 2020. The Government proposes to update the consolidated circular on Consolidated FDI Policy once every year and therefore, the Consolidated FDI Policy will be valid until the DPIIT issues an updated circular.

On October 17, 2019, the Ministry of Finance, Department of Economic Affairs, had notified the FEMA Rules, which had replaced the Foreign Exchange Management (Transfer and Issue of Security by a Person Resident Outside India) Regulations 2017. Foreign investment in this Offer shall be on the basis of the FEMA Rules. Further, in accordance with Press Note No. 3 (2020 Series), dated April 17, 2020 issued by the DPIIT and the Foreign Exchange Management (Non-debt Instruments) Amendment Rules, 2020 which came into effect from April 22, 2020, any investment, subscription, purchase or sale of equity instruments by entities of a country which shares land border with India or where the beneficial owner of an investment into India is situated in or is a citizen of any such country, will require prior approval of the Government, as prescribed in the Consolidated FDI Policy and the FEMA Rules. Further, in the event of transfer of ownership of any existing or future foreign direct investment in an entity in India, directly or indirectly, resulting in the beneficial ownership falling within the aforesaid restriction/ purview, such subsequent change in the beneficial ownership will also require approval of the Government. Furthermore, on April 22, 2020, the Ministry of Finance, Government of India has also made a similar amendment to the FEMA Rules. Pursuant to the Foreign Exchange Management (Non-debt Instruments) (Fourth Amendment) Rules, 2020 issued on December 8, 2020, a multilateral bank or fund, of which India is a member, shall not be treated as an entity of a particular country nor shall any country be treated as the beneficial owner of the investments of such bank of fund in India. These investment restrictions shall also apply to subscribers of offshore derivative instruments. Each Bidder should seek independent legal advice about its ability to participate in the Offer. In the event such prior approval of the Government of India is required, and such approval has been obtained, the Bidder shall intimate the Company and the Registrar to the Offer in writing about such approval along with a copy thereof within the Bid/Offer Period.

The transfer of shares between an Indian resident and a non-resident does not require the prior approval of the RBI, provided that (i) the activities of the investee company are under the automatic route under the Consolidated FDI Policy and such transfer does not attract the provisions of the SEBI Takeover Regulations; (ii) the non-resident shareholding is within the sectoral limits under the Consolidated FDI Policy; and (iii) the pricing is in accordance with the guidelines prescribed by SEBI and RBI.

Pursuant to the resolution dated March 16, 2023 passed by our Board and resolution dated March 20, 2023 passed by our shareholders, the aggregate investment limit by NRIs and OCIs was increased from 10% to 24% of the paid-up equity share capital of our Company, provided however, that the shareholding of each NRI or OCI shall not exceed 5% of the total paid-up equity capital of our Company on a fully diluted basis or such other limit as may be stipulated by RBI in each case, from time to time and the total holdings of all NRIs and OCIs put together shall not exceed 24% of the total paid-up equity capital on a fully diluted basis.

As per the existing policy of the Government, OCBs cannot participate in the Offer. For further details, see “*Offer Procedure*” beginning on page 436.

The Equity Shares offered in the Offer have not been, and will not be, registered under the U.S. Securities Act of 1933, as amended (the “U.S. Securities Act”) and may not be offered or sold within the United States, except pursuant to an exemption from, or in a transaction not subject to, the registration requirements of the U.S. Securities Act and accordingly, the Equity Shares are being offered and sold (i) within the United States solely to persons who are reasonably believed to be “qualified institutional buyers” (as defined in Rule 144A under the U.S. Securities Act) in transactions exempt from the registrations requirements of the U.S. Securities Act, and (ii) outside the United States in “offshore transactions” as defined in and in reliance on Regulation S under the U.S. Securities Act and the applicable laws of the jurisdiction where those offers and sales occur. There will be no public offering of Equity Shares in the United States.

The Equity Shares have not been and will not be registered, listed or otherwise qualified in any other jurisdiction outside India and may not be offered or sold, and Bids may not be made by persons in any such jurisdiction, except in compliance with the applicable laws of such jurisdiction.

The above information is given for the benefit of the Bidders. Our Company, the Selling Shareholders, the Book Running Lead Managers are not liable for any amendments or modification or changes in applicable laws or regulations, which may occur after the date of this Red Herring Prospectus. Bidders are advised to make their independent investigations and ensure that the number of Equity Shares Bid for do not exceed the applicable limits under laws or regulations.

SECTION VIII: MAIN PROVISIONS OF ARTICLES OF ASSOCIATION

Capitalized terms used in this section have the meaning that has been given to such terms in the Articles of Association of our Company..

Authorised Share Capital

Article 5 provides that the authorised share capital of the Company shall be such amount, divided into such class(es), denomination(s) and number of shares in the Company as may from time to time be provided in Clause V of the Memorandum of Association, with power to increase or reduce such capital and/or the nominal value of the shares forming part thereof from time to time and power to divide share capital into other classes and to attach thereto respectively such preferential, convertible, deferred, qualified, or other special rights, privileges, conditions or restrictions and to consolidate or sub-divide the shares and issue shares of higher or lower denominations and to vary, modify or abrogate the same in such manner as may be determined by or in accordance with the Articles of the Company, subject to the provisions of applicable law for the time being in force.

Sub-Division, Consolidation and Cancellation of Share Capital

Article 10 provides that subject to the provisions of the Act, the Company may:

- (a) increase the share capital by such sum, to be divided into shares of such amount as it thinks expedient;
- (b) divide, sub-divide or consolidate its shares, or any of them, and the resolution whereby any share is sub-divided, may determine that as between the holders of the shares resulting from such sub-division one or more of such shares have some preference or special advantage in relation to dividend, capital or otherwise as compared with the others;
- (c) cancel shares which at the date of such General Meeting have not been taken or agreed to be taken by any person and diminish the amount of its share capital by the amount of the shares so cancelled;
- (d) consolidate and divide all or any of its share capital into shares of larger amount than its existing shares; provided that any consolidation and division which results in changes in the voting percentage of Members shall require applicable approvals under the Act;
- (e) convert all or any of its fully paid-up shares into stock, and reconvert that stock into fully paid-up shares of any denomination; and
- (f) The cancellation of shares under point (c) above shall not be deemed to be a reduction of the authorised share capital.

Variation of Shareholders' Rights

Article 18 provides that:

- (a) If at any time the share capital of the Company is divided into different classes of shares, the rights attached to the shares of any class (unless otherwise provided by the terms of issue of the shares of that class) may, subject to provisions of Section 48 of the Act and whether or not the Company is being wound up, be varied with the consent in writing of the holders of not less than three-fourth of the issued shares of that class or with the sanction of a Special Resolution passed at a separate meeting of the holders of the issued shares of that class, as prescribed by the Act.
- (b) Subject to the provisions of the Act, to every such separate meeting, the provisions of the Articles of the Company relating to meeting shall *mutatis mutandis* apply, but so that the necessary quorum shall be at least two persons holding at least one-third of the issued shares of the class in question.

Share Certificate

Article 21 provides that every Member shall be entitled, without payment, to one or more certificates in marketable lots, for all the shares of each class or denomination registered in their name, or if the Directors so approve (upon paying such fee as the Directors so determine) to several certificates, each for one or more of such shares and the Company shall complete and have ready for delivery such certificates, unless prohibited by any provision of law or any order of court, tribunal or other authority having jurisdiction, within two (2) months from the date of allotment, or within one (1) month of the receipt of application of registration of transfer, transmission, sub division, consolidation or renewal of any of its shares as the case maybe or within such other period as any other legislation for time being in force may provide or within a period of six (6) months from the date of allotment in the case of any allotment of debenture or within such other period as any other legislation for time being in force may provide. In respect of any share or shares held jointly by several persons, the Company shall not be bound to issue more than one (1) certificate, and delivery of a certificate for a share to one of several joint holders shall be sufficient delivery to all such joint holders. The Company may issue several certificates, each for one or more of their shares, upon payment of twenty rupees for each certificate after the first.

Every certificate shall specify the shares to which it relates and the amount paid-up thereon and shall be signed by two (2) directors or by a director and the company secretary, wherever the Company has appointed a company secretary.

The Company may sub-divide or consolidate the share certificates.

Lien

Article 25 provides that the Company shall subject to applicable law have a first and paramount lien on every share / debenture (not being a fully paid-up share / debenture) registered in the name of each Member (whether solely or jointly with others) and upon the proceeds of sale thereof for all moneys (whether presently payable or not) called, or payable at a fixed time, in respect of that share / debenture and no equitable interest in any share shall be created upon the footing and condition that this Article will have full effect. Unless otherwise agreed, the registration of transfer of shares / debentures shall operate as a waiver of the Company's lien, if any, on such shares / debentures.

Provided that the Board may at any time declare any share to be wholly or in part exempt from the provisions of this Article.

The fully paid-up shares shall be free from all lien and in the case of partly paid-up shares the Company's lien shall be restricted to moneys called or payable at a fixed time in respect of such shares.

Article 26 provides that the Company's lien, if any, on a share shall extend to all dividends or interest, as the case may be, payable and bonuses declared from time to time in respect of such shares / debentures.

Article 27 provides that the Company may sell, in such manner as the Board thinks fit, any shares on which the Company has a lien:

Provided that no sale shall be made:

- (a) unless a sum in respect of which the lien exists is presently payable; or
- (b) until the expiration of fourteen (14) days' after a notice in writing stating and demanding payment of such part of the amount in respect of which the lien exists as is presently payable, has been given to the registered holder for the time being of the share or to the person entitled thereto by reason of his death or insolvency or otherwise.

No Member shall exercise any voting right in respect of any shares registered in his name on which any calls or other sums presently payable by him have not been paid, or in regard to which the Company has exercised any right of lien.

Article 28 provides that to give effect to any such sale, the Board may authorise some person to transfer the shares sold to the purchaser thereof. The purchaser shall be registered as the holder of the shares comprised in any such transfer. The purchaser shall not be bound to see to the application of the purchase money, nor shall his title to the shares be affected by any irregularity or invalidity in the proceedings with reference to the sale.

Article 29 provides that the proceeds of any such sale shall be received by the Company and applied in payment of such part of the amount in respect of which the lien exists as is presently payable and the residue, if any, shall (subject to a like lien for sums not presently payable as existed upon the shares before the sale) be paid to the person entitled to the shares at the date of the sale.

Article 30 provides that in exercising its lien, the Company shall be entitled to treat the registered holder of any share as the absolute owner thereof and accordingly shall not (except as ordered by a court of competent jurisdiction or unless required by law) be bound to recognise any equitable or other claim to, or interest in, such share on the part of any other person, whether a creditor of the registered holder or otherwise. The Company's lien shall prevail notwithstanding that it has received notice of any such claim.

Article 31 provides that the provisions of the Articles of the Company relating to lien shall *mutatis mutandis* apply to any other securities, including debentures, of the Company.

Forfeiture of Shares

Article 41 provides that if a Member fails to pay any call, or installment of a call or any money due in respect of any share on the day appointed for payment thereof, the Board may, at any time thereafter during such time as any part of the call or installment remains unpaid or a judgment or decree in respect thereof remains unsatisfied in whole or in part, serve a notice on him requiring payment of so much of the call or installment or other money as is unpaid, together with any interest which may have accrued and all expenses that may have been incurred by the Company by reason of non-payment.

Article 42 provides that the notice aforesaid shall:

- (a) name a further day (not being earlier than the expiry of fourteen (14) days from the date of service of the notice) on or before which the payment required by the notice is to be made; and
- (b) state that, in the event of non-payment on or before the day so named, the shares in respect of which the call was made shall be liable to be forfeited.

If the requirements of any such notice as aforesaid are not complied with, any share in respect of which the notice has been given may, at any time thereafter, before the payment required by the notice has been made, be forfeited by a resolution of the Board to that effect.

Article 43 provides that neither a judgment nor a decree in favour of the Company for calls or other moneys due in respect of any shares nor any part payment or satisfaction thereof nor the receipt by the Company of a portion of any money which shall from time to time be due from any Member in respect of any shares either by way of principal or interest nor any indulgence granted by the Company in respect of payment of any such money shall preclude the forfeiture of such shares as herein provided.

There shall be no forfeiture of unclaimed dividends before the claim becomes barred by applicable law.

Article 44 provides that any share forfeited in accordance with the Articles of the Company, shall be deemed to be the property of the Company and may be sold, re-allocated or otherwise disposed of either to the original holder thereof or to any other person upon such terms and in such manner as the Board thinks fit.

Article 45 provides that when any share shall have been so forfeited, notice of the forfeiture shall be given to the defaulting member and any entry of the forfeiture with the date thereof, shall forthwith be made in the Register of Members but no forfeiture shall be invalidated by any omission or neglect or any failure to give such notice or make such entry as aforesaid.

Article 46 provides that a person whose shares have been forfeited shall cease to be a Member in respect of the forfeited shares, but shall, notwithstanding the forfeiture, remain liable to pay, and shall pay, to the Company all monies which, at the date of forfeiture, were presently payable by him to the Company in respect of the shares. All such monies payable shall be paid together with interest thereon at such rate as the Board may determine, from the time of forfeiture until payment or realization. The Board may, if it thinks fit, but without being under any obligation to do so, enforce the payment of the whole or any portion of the monies due, without any allowance for the value of the shares at the time of forfeiture or waive payment in whole or in part. The liability of such person shall cease if and when the Company shall have received payment in full of all such monies in respect of the shares.

Article 47 provides that the forfeiture of a share shall involve extinction at the time of forfeiture, of all interest in and all claims and demands against the Company, in respect of the share and all other rights incidental to the share, except only such of those rights as by the Articles of the Company expressly saved.

Article 58 provides that a duly verified declaration in writing that the declarant is a director, the manager or the secretary of the Company, and that a share in the Company has been duly forfeited on a date stated in the declaration, shall be conclusive evidence of the facts therein stated as against all persons claiming to be entitled to the share.

Article 49 provides that the Company may receive the consideration, if any, given for the share on any sale, re-allotment or disposal thereof and may execute a transfer of the share in favour of the person to whom the share is sold or disposed of. The transferee shall thereupon be registered as the holder of the share and the transferee shall not be bound to see to the application of the purchase money, if any, nor shall his title to the share be affected by any irregularity or invalidity in the proceedings in reference to the forfeiture, sale, re-allotment or disposal of the share.

Article 50 provides that upon any sale after forfeiture or for enforcing a lien in exercise of the powers hereinabove given, the Board may, if necessary, appoint some person to execute an instrument for transfer of the shares sold and cause the purchaser's name to be entered in the Register of Members in respect of the shares sold and after his name has been entered in the Register of Members in respect of such shares the validity of the sale shall not be impeached by any person.

Article 51 provides that upon any sale, re-allotment or other disposal under the provisions of the preceding Articles, the certificate(s), if any, originally issued in respect of the relative shares shall (unless the same shall on demand by the Company has been previously surrendered to it by the defaulting member) stand cancelled and become null and void and be of no effect, and the Board shall be entitled to issue a duplicate certificate(s) in respect of the said shares to the person(s) entitled thereto.

Article 52 provides that:

- (a) A forfeited share may be sold or reallocated otherwise disposed of on such terms and in such manner as the Board thinks fit.
- (b) At any time before a sale or disposal as aforesaid, the Board may cancel the forfeiture on such terms as it thinks fit.

Article 53 provides that the Board may, subject to the provisions of the Act, accept a surrender of any share from or by any Member desirous of surrendering them on such terms as they think fit.

Article 54 provides that the provisions of the Articles of the Company as to forfeiture shall apply in the case of non-payment of any sum which, by the terms of issue of a share, becomes payable at a fixed time, whether on account of the nominal value of the share or by way of premium, as if the same had been payable by virtue of a call duly made and notified.

Article 55 provides that the provisions of the Articles of the Company relating to forfeiture of shares shall *mutatis mutandis* apply to any other securities, including debentures, of the Company.

Transfer and Transmission of Shares

Article 58 provides that:

- (a) The instrument of transfer of any share shall be in writing and all the provisions of the Act, and of any statutory modification thereof for the time being shall be duly complied with in respect of all transfer of shares and registration thereof. The Company shall use the form of transfer, as prescribed under the Act, in all cases. In case of transfer of shares, where the Company has not issued any certificates and where the shares are held in dematerialized form, the provisions of the Depositories Act, 1996 shall apply.
- (b) The Board may decline to recognize any instrument of transfer unless:
 - (i) the instrument of transfer is in the form prescribed under the Act;
 - (ii) the instrument of transfer is accompanied by the certificate of shares to which it relates, and such other evidence as the Board may reasonably require to show the right of the transferor to make the transfer; and
 - (iii) the instrument of transfer is in respect of only one class of shares.
- (c) No fee shall be charged for registration of transfer, transmission, probate, succession certificate and letters of administration, certificate of death or marriage, power of attorney or similar other document.

Article 61 provides that subject to the provisions of the Articles of the Company and other applicable provisions of the Act or any other law for the time being in force, the Board may (at its own absolute and uncontrolled discretion) decline or refuse by giving reasons, whether in pursuance of any power of the Company under the Articles of the Company or otherwise, to register or acknowledge any transfer of, or the transmission by operation of law of the right to, any securities or interest of a Member in the Company, after providing sufficient cause, within a period of thirty (30) days from the date on which the instrument of transfer, or the intimation of such transmission, as the case may be, was delivered to the Company. Provided that the registration of transfer of any securities shall not be refused on the ground of the transferor being alone or jointly with any other person or persons, indebted to the Company on any account whatsoever except where the Company has a lien on shares. Transfer of shares/debentures in whatever lot shall not be refused.

Article 62 provides that where in the case of partly paid-up shares, an application for registration is made by the transferor alone, the transfer shall not be registered, unless the Company gives the notice of the application to the transferee in accordance with the provisions of the Act and the transferee gives no objection to the transfer within the time period prescribed under the Act.

Article 63 provides that the executors or administrators or the holders of a succession certificate issued in respect of the shares of a deceased Member and not being one of several joint holders shall be the only person whom the Company shall recognize as having any title to the shares registered in the name of such Members and in case of the death of one or more of the joint holders of any registered share, the survivor or survivors shall be entitled to the title or interest in such shares but nothing herein contained shall be taken to release the estate of a deceased joint holder from any liability on shares held by him jointly with any other person. Provided nevertheless that in case the Directors, in their absolute discretion think fit, it shall be lawful for the Directors to dispense with the production of a probate or letters of administration or a succession certificate or such other legal representation upon such terms (if any) (as to indemnify or otherwise) as the Directors may consider necessary or desirable.

Article 64 provides that no share shall in any circumstances be transferred to any infant, insolvent or a person of unsound mind, except fully paid-up shares through a legal guardian.

Article 65 provides that subject to the provisions of the Act and the Articles of the Company, any person becoming entitled to shares in consequence of the death, lunacy, bankruptcy or insolvency of any Members, or by any lawful means other than by a transfer in accordance with the Articles of the Company, may with the consent of the Board (which it shall not be under any obligation to give), upon producing such evidence as the Board thinks sufficient, that he sustains the character in respect of which he proposes to act under this Article, or of his title, elect to either be registered himself as holder of the shares or elect to have some person nominated by him and approved by the Board, registered as such holder or to make such transfer of the share as the deceased or insolvent member could have made. If the person so becoming entitled shall elect to be registered as holder of the share himself, he shall deliver or send to the Company a notice in writing signed by him stating that he so elects. Provided, nevertheless, if such person shall elect to have his nominee registered, he shall testify that election by executing in favour of his nominee an instrument of transfer in accordance with the provision herein contained and until he does so he shall not be freed from any liability in respect of the shares. Further, all limitations, restrictions and provisions of these regulations relating to the right to transfer and the registration of transfer of shares shall be applicable to any such notice or transfer as aforesaid as if the death or insolvency of the Member had not occurred and the notice or transfer were a transfer signed by that Member.

Article 66 provides that a person becoming entitled to a share by reason of the death or insolvency of the holder shall, subject to the Directors' right to retain such dividends or money, be entitled to the same dividends and other advantages to which he would be entitled if he were the registered holder of the share, except that he shall not, before being registered as a Member in respect of the share, be entitled in respect of it to exercise any right conferred by membership in relation to meetings of the Company.

Provided that the Board may at any time give a notice requiring any such person to elect either to be registered himself or to transfer the share and if the notice is not complied with within ninety (90) days, the Board may thereafter withhold payment of all dividends, bonus or other moneys payable in respect of such share, until the requirements of notice have been complied with.

Article 67 provides that before the registration of a transfer, the certificate or certificates of the share or shares to be transferred must be delivered to the Company along with (save as provided in the Act) properly stamped and executed instrument of transfer.

Article 69 provides that the provisions of the Articles of the Company, shall, *mutatis mutandis*, apply to the transfer of or the transmission by law of the right to any securities including, debentures of the Company.

Vote of Members

Article 92 provides that subject to any rights or restrictions for the time being attached to any class or classes of shares:

- (a) On a show of hands every Member holding Equity Shares and present in person shall have one vote.
- (b) On a poll, every Member holding Equity Shares shall have voting rights in proportion to his share in the paid-up equity share capital.
- (c) A Member may exercise his vote at a meeting by electronic means in accordance with the Act and shall vote only once.

Article 93 provides that in case of joint holders the vote of first named of such joint holders in the Register of Members who tender a vote whether in person or by proxy shall be accepted, to the exclusion of the votes of other joint holders.

Article 94 provides that a Member of unsound mind, or in respect of whom an order has been made by any court having jurisdiction in lunacy, may vote, whether on a show of hands or on a poll, by his committee or other legal guardian, and any such committee or legal guardian may, on a poll, vote by proxy.

Article 95 provides that no Member shall be entitled to vote at any General Meeting unless all calls or other sums presently payable by such Member have been paid, or in regard to which the Company has lien and has exercised any right of lien.

Article 96 provides that subject to the provisions of the Act and the Articles of the Company, any Member entitled to attend and vote at a General Meeting may do so either personally or through his constituted attorney or through another person as a proxy on his behalf, for that meeting.

Article 97 provides that an instrument appointing a proxy shall be in the form as prescribed under the Act for this purpose. The instrument appointing a proxy shall be in writing under the hand of appointer or of his attorney duly authorized in writing or if appointed by a body corporate either under its common seal or under the hand of its officer or attorney duly authorized in writing by it. Any person whether or not he is a Member of the Company may be appointed as a proxy.

The instrument appointing a proxy and power of attorney or other authority (if any) under which it is signed or a notarized copy of that power or authority must be deposited at the Office of the Company not less than forty eight (48) hours prior to the time fixed for holding the meeting or adjourned meeting at which the person named in the instrument proposes to vote, or, in case of a poll, not less than twenty four (24) hours before the time appointed for the taking of the poll, and in default the instrument of proxy shall not be treated as valid.

Article 98 provides that a vote given in accordance with the terms of an instrument of proxy shall be valid, notwithstanding the previous death or insanity of the principal or the revocation of the proxy or of the authority under which the proxy was executed, or the transfer of shares in respect of which the proxy is given, provided that no intimation in writing of such death, insanity, revocation or transfer shall have been received by the Company at its Office before the commencement of the meeting or adjourned meeting at which the proxy is used.

Article 99 provides that any corporation which is a Member of the Company may, by resolution of its Board of Directors or other governing body, authorize such person as it thinks fit to act as its representative at any meeting of the Company and the said person so authorized shall be entitled to exercise the same powers on behalf of the corporation which he represents as that corporation could have exercised if it were an individual Member of the Company (including the right to vote by proxy).

Directors

Article 100 provides that unless otherwise determined by General Meeting, the number of Directors shall not be less than three (3) and not more than fifteen (15), and at least one (1) Director shall be resident of India in the previous year.

Provided that the Company may appoint more than fifteen (15) directors after taking approval of the shareholders as per applicable provisions / laws.

Article 101 provides that notwithstanding anything to the contrary set out in the Articles of the Company:

Authority of the Board: Subject to the provisions of the Act, the Board shall be responsible for the management, supervision, direction and control of the Company.

Proceedings of the Board of Directors

Article 116 provides that:

- (a) The Board of Directors shall meet at least once in every three (3) months with a maximum gap of 120 (one hundred and twenty) days between two (2) meetings of the Board for the dispatch of business, adjourn and otherwise regulate its meetings and proceedings as it thinks fit in accordance with the Act, provided that at least four (4) such meetings shall be held in every year. Place of meetings of the Board shall be at a location determined by the Board at its previous meeting, or if no such determination is made, then as determined by the chairman of the Board.
- (b) The chairman may, at any time, and the secretary or such other Officer of the Company as may be authorised in this behalf on the requisition of Director shall at any time summon a meeting of the Board. Notice of at least seven (7) days in writing of every meeting of the Board shall be given to every Director and every alternate Director at his usual address whether in India or abroad, provided always that a meeting may be convened by a shorter notice to transact urgent business subject to the condition that at least one independent director, if any, shall be present at the meeting and in case of absence of independent directors from such a meeting of the Board, decisions taken at such a meeting shall be circulated to all the directors and shall be final only on ratification thereof by at least one independent director, if any.
- (c) The notice of each meeting of the Board shall include (i) the time for the proposed meeting; (ii) the venue for the proposed meeting; and (iii) an agenda setting out the business proposed to be transacted at the meeting.
- (d) To the extent permissible by applicable law, the Directors may participate in a meeting of the Board or any Committee thereof, through electronic mode, that is, by way of video conferencing or by any other audio visual electronic communication facility. The notice of the meeting must inform the Directors regarding the availability of participation through video conferencing. Any Director participating in a meeting through the use of video conferencing shall be counted for the purpose of quorum.

Borrowing Powers

Article 128 provides that:

- (a) Subject to the provisions of the Act and the Articles of the Company, the Board may from time to time at their discretion raise or borrow or secure the payment of any such sum of money for the purpose of the Company, in such manner and upon such terms and conditions in all respects as they think fit, and in particular, by promissory notes or by receiving deposits and advances with or without security or by the issue of bonds, debentures, perpetual or otherwise, including debentures convertible into shares of this Company or any other company or perpetual annuities and to secure any such money so borrowed, raised or received, mortgage, pledge or charge the whole or any part of the property, assets or revenue of the Company present or future, including its uncalled capital by special assignment or otherwise or to transfer or convey the same absolutely or in trust and to give the lenders powers of sale and other powers as may be expedient and to purchase, redeem or pay off any such securities; provided however, that the moneys to be borrowed, together with the money already borrowed by the Company apart from temporary loans (*as defined under Section 180(1) of the Act*) obtained from the Company's bankers in the ordinary course of business shall not, without the sanction of the Company by approval of Shareholders at a General Meeting as per applicable provisions / laws, exceed the aggregate of the paid-up share capital of the Company, its free reserves and securities premium. Provided that every such approval of Shareholders by the Company in General Meeting as per applicable provisions / laws in relation to the exercise of the power to borrow shall specify the total amount up to which moneys may be borrowed by the Board of Directors.
- (b) The Directors may by resolution at a meeting of the Board delegate the above power to borrow money otherwise than on debentures to a Committee of Directors or managing Director or to any other person permitted by applicable law, if any, within the limits prescribed.
- (c) To the extent permitted under the applicable law and subject to compliance with the requirements thereof, the Directors shall be empowered to grant loans to such entities at such terms as they may deem to be appropriate and the same shall be in the interests of the Company.
- (d) Any bonds, debentures, debenture-stock or other securities may if permissible under applicable law be issued at a discount, premium or otherwise by the Company and shall with the consent of the Board be issued upon such terms and conditions and in such manner and for such consideration as the Board shall consider to be for the benefit of the Company, and on the condition that they or any part of them may be convertible into Equity Shares of any denomination, and with any privileges and conditions as to the redemption, surrender, allotment of shares, attending (but not voting) in the General Meeting, appointment of Directors or otherwise. Provided that debentures with rights

to allotment of or conversion into Equity Shares shall not be issued except with, the sanction of the Company in General Meeting accorded as per applicable provisions / laws.

Managing Director(s) and/or Whole-Time Directors

Article 130 provides that:

- (a) The Board may from time to time and with such sanction of the Central Government as may be required by the Act, appoint one or more of the Directors to the office of the managing director and/ or whole-time directors for such term and subject to such remuneration, terms and conditions as they may think fit.
- (b) The Directors may from time to time resolve that there shall be either one or more managing directors and/ or whole-time directors.
- (c) In the event of any vacancy arising in the office of a managing director and/or whole-time director, the vacancy shall be filled by the Board of Directors subject to the approval of the Members, as required under applicable law.
- (d) If a managing director and/or whole-time director ceases to hold office as Director, he shall ipso facto and immediately cease to be managing director/whole time director.
- (e) The managing director and/or whole-time director shall not be liable to retirement by rotation as long as he holds office as managing director or whole-time director.

Chief Executive Officer, Manager, Company Secretary and Chief Financial Officer

Article 133 provides that subject to the provisions of the Act:

- (a) A chief executive officer, manager, company secretary and chief financial officer may be appointed by the Board for such term, at such remuneration and upon such conditions as it may think fit; and any chief executive officer, manager, company secretary and chief financial officer so appointed may be removed by means of a resolution of the Board.
- (b) A director may be appointed as chief executive officer, manager, company secretary or chief financial officer. Further, an individual may be appointed or reappointed as the chairperson of the Company as well as the managing Director or chief executive officer of the Company at the same time.
- (c) A provision of the Act or the Articles requiring or authorising a thing to be done by or to a Director and chief executive officer, manager, company secretary or chief financial officer shall not be satisfied by its being done by or to the same person acting both as a Director and as, or in place of, chief executive officer, manager, company secretary or chief financial officer.

Dividend

Article 134 provides that the Company in General Meeting may declare dividends, but no dividend shall exceed the amount recommended by the Board.

Article 135 provides that subject to the provisions of the Act, the Board may from time to time pay to the members such interim dividends of such amount on such class of shares and at such times as it may think fit and as appear to it to be justified by the profits of the company.

Article 136 provides that:

- (a) Where capital is paid in advance of calls on shares, such capital, whilst carrying interest, shall not confer a right to dividend or to participate in the profits.
- (b) Where the Company has declared a dividend but which has not been paid or claimed within thirty (30) days from the date of declaration, the Company shall within seven (7) days from the date of expiry of the said period of thirty (30) days, transfer the total amount of dividend which remains unpaid or unclaimed within the said period of thirty (30) days, to a special account to be opened by the Company in that behalf in any scheduled bank to be called "Unpaid Dividend Account of R R Kabel Limited".
- (c) Any money transferred to the unpaid dividend account of the Company which remains unpaid or unclaimed for a period of seven (7) years from the date of such transfer, shall be transferred by the Company to the fund known as Investor Education and Protection Fund established under the Act subject to the provisions of the Act and the rules.
- (d) No unclaimed or unpaid dividend shall be forfeited by the Board before the claim becomes barred by law.
- (e) All other provisions under the Act will be complied with in relation to the unpaid or unclaimed dividend.

Article 137 provides that subject to the rights of persons, if any, entitled to shares with special rights as to dividends, all dividends shall be declared and paid according to the amounts paid or credited as paid on the shares in respect whereof the dividend is paid, but if and so long as nothing is paid upon any of the shares in the Company, dividends may be declared and paid according to the amounts of the shares.

Article 138 provides that all dividends shall be apportioned and paid proportionately to the amounts paid or credited as paid on the shares during any portion or portions of the period in respect of which the dividend is paid; but if any share is issued on terms providing that it shall rank for dividend as from a particular date such share shall rank for dividend accordingly.

Article 139 provides that -

- (a) The Board may, before recommending any dividends, set aside out of the profits of the Company such sums as it thinks proper as a reserve or reserves which shall at the discretion of the Board, be applied for any purpose to which the profits of the Company may be properly applied, including provision for meeting contingencies or for equalizing dividends and pending such application, may, at the like discretion either be employed in the business of the Company or be invested in such investments (other than shares of the Company) as the Board may, from time to time think fit.
- (b) The Board may also carry forward any profits when it may consider necessary not to divide, without setting them aside as a reserve.

Article 140 provides that subject to the Act, no Member shall be entitled to receive payment of any interest or dividend in respect of his share or shares whilst any money may be due or owing from him to the Company in respect of such share or shares of or otherwise howsoever whether alone or jointly with any other person or persons and the Board may deduct from any dividend payable to any Members all sums of money, if any, presently payable by him to the Company on account of the calls or otherwise in relation to the shares of the Company.

Article 141 provides that the Board may retain dividends payable upon shares in respect of which any person is, under Articles 58 to 71 hereinbefore contained, entitled to become a Member, until such person shall become a Member in respect of such shares.

Article 142 provides that Any one of two or more joint holders of a share may give effective receipt for any dividends, bonuses or other moneys payable in respect of such shares.

Article 143 provides that Any dividend, interest or other monies payable in cash in respect of shares may be paid by electronic mode or by cheque or warrant sent through the post directed to the registered address of the holder or, in the case of joint holders, to the registered address of that one of the joint holders who is first named on the Register of Members, or to such person and to such address as the holder or joint holders may in writing direct. Every such cheque or warrant shall be made payable to the order of the person to whom it is sent.

Article 144 provides that No dividends shall bear interest against the Company.

Article 145 provides that Subject to the provisions of the Act, any transfer of shares shall not pass the right to any dividend declared thereon before the registration of the transfer.

Winding Up

Article 157 provides that subject to the applicable provisions of the Act:

- (a) If the Company shall be wound up, the liquidator may, with the sanction of Shareholders of the Company as per applicable provisions / laws and any other sanction required by the Act, divide amongst the members, in specie or kind, the whole or any part of the assets of the Company, whether they shall consist of property of the same kind or not.
- (b) For the purpose aforesaid, the liquidator may set such value as he deems fair upon any property to be divided as aforesaid and may determine how such division shall be carried out as between the Members or different classes of Members.
- (c) The liquidator may, with the like sanction, vest the whole or any part of such assets in trustees upon such trusts for the benefit of the contributories if he considers necessary, but so that no member shall be compelled to accept any shares or other securities whereon there is any liability.
- (d) Any person who is or has been a Director or manager, whose liability is unlimited under the Act, shall, in addition to his liability, if any, to contribute as an ordinary member, be liable to make a further contribution as if he were at the commencement of winding up, a member of an unlimited company, in accordance with the provisions of the Act.

Indemnity

Article 159 provides that subject to the provisions of the Act and other applicable law, every Director and Officer of the Company shall be indemnified by the Company against any liability incurred by him in his capacity as Director or Officer of the Company including in relation to defending any proceedings, whether civil or criminal, in which judgment is given in his favour or in which he is acquitted or in which relief is granted to him by the court or the tribunal. Provided, however, that such indemnification shall not apply in respect of any cost or loss or expenses to the extent it is finally judicially determined to have resulted from the negligence, wilful misconduct or bad faith acts or omissions of such Director or officer of the Company.

SECTION IX: OTHER INFORMATION

MATERIAL CONTRACTS AND DOCUMENTS FOR INSPECTION

The copies of the following documents and contracts which have been entered or are to be entered into by our Company (not being contracts entered into in the ordinary course of business carried on by our Company) which are or may be deemed material will be attached to the copy of this Red Herring Prospectus which will be filed with the RoC. Copies of the contracts and documents for inspection referred to hereunder, may be inspected at our Registered Office between 10 a.m. to 5 p.m. on all Working Days from date of this Red Herring Prospectus until the Bid/ Offer Closing Date. The copies of the contracts and documents for inspection referred to hereunder will be uploaded on the website of our Company at www.rrkabel.com/others, and will be available for inspection from date of this Red Herring Prospectus until the Bid/ Offer Closing Date (except for such agreements executed after the Bid/Offer Closing Date).

A. Material contracts for the Offer

- (1) Offer Agreement dated May 5, 2023 amongst our Company, the Selling Shareholders and the BRLMs.
- (2) Registrar Agreement dated May 5, 2023 amongst our Company, the Selling Shareholders, and the Registrar to the Offer.
- (3) Cash Escrow and Sponsor Bank Agreement dated September 6, 2023, amongst our Company, the Selling Shareholders, the Registrar to the Offer, the BRLMs, the Syndicate Members, the Escrow Collection Bank, Sponsor Banks, Public Offer Bank and the Refund Bank.
- (4) Share Escrow Agreement dated September 5, 2023, amongst the Selling Shareholders, our Company and the Share Escrow Agent.
- (5) Syndicate Agreement dated September 6, 2023, amongst our Company, the Selling Shareholders, the BRLMs, and Syndicate Members.
- (6) Monitoring Agency Agreement dated September 6, 2023, entered into between our Company and the Monitoring Agency.
- (7) Underwriting Agreement dated [●] amongst our Company, the Selling Shareholders, and the Underwriters.

B. Material Documents

- (1) Certified copies of updated MoA and AoA, amended from time to time.
- (2) Certificate of incorporation of our Company dated February 6, 1995, and fresh certificate of incorporation dated November 8, 2000, issued to our Company by the RoC.
- (3) Shareholders' Agreement dated July 7, 2018 entered between our Company, our Promoters, TPG Asia VII SF Pte. Ltd. and certain other parties, as amended and supplemented pursuant to deed of adherence dated December 3, 2019, deed of adherence dated October 11, 2021 and deed of adherence dated January 24, 2022 and further amended pursuant to the SHA Amendment Agreement and SHA Second Amendment Agreement.
- (4) Waiver cum amendment agreement dated May 3, 2023, to the Shareholders' Agreement, entered between our Company, our Promoters, TPG Asia VII SF Pte. Ltd. and certain other parties.
- (5) SHA second amendment agreement dated August 30, 2023, to the Shareholders' Agreement, entered between our Company, our Promoters, the Investor Selling Shareholder and certain other parties.
- (6) Trademark license agreement dated April 29, 2015 between our Company and Ram Ratna Research and Holdings Private Limited, as amended by the amendment to the trademark license agreement dated August 10, 2018.
- (7) Resolution of the Board of Directors dated February 13, 2023, authorising the Offer and other related matters.
- (8) Shareholders' resolution dated March 20, 2023, in relation to the Offer, approving the Fresh Issue and other related matters.
- (9) Resolution of the Audit Committee dated August 30, 2023, approving our key performance indicators.
- (10) Resolution of the Board of Directors dated December 16, 2022, in relation to approval of the terms of remuneration of our Executive Chairman, Tribhuvanprasad Rameshwarlal Kabra and Managing Director, Shreegopal Rameshwarlal Kabra.
- (11) Resolution of the Board of Directors dated May 5, 2023, approving the DRHP.

- (12) Resolution of the Board of Directors dated September 6, 2023, approving this Red Herring Prospectus.
- (13) Consent letter dated May 5, 2023, provided by Mahendrakumar Rameshwarlal Kabra, consenting to participate in the Offer for Sale.
- (14) Consent letter dated May 5, 2023, provided by Hemant Mahendrakumar Kabra, consenting to participate in the Offer for Sale.
- (15) Consent letter dated August 31, 2023, provided by Sumeet Mahendrakumar Kabra, consenting to participate in the Offer for Sale.
- (16) Consent letter dated May 5, 2023, provided by Kabel Buildcon Solutions Private Limited, consenting to participate in the Offer for Sale.
- (17) Consent letter dated May 5, 2023, provided by Ram Ratna Wires Limited, consenting to participate in the Offer for Sale.
- (18) Consent letter dated August 31, 2023, provided by TPG Asia VII SF Pte. Ltd., consenting to participate in the Offer for Sale.
- (19) Consent dated September 6, 2023, from our Statutory Auditor, namely, B S R & Co. LLP, Chartered Accountants, to include their name as required under section 26(5) of the Companies Act, 2013 read with SEBI ICDR Regulations, in this DRHP, and as an “expert” as defined under section 2(38) of the Companies Act, 2013 in respect of their (a) examination report dated August 30, 2023, on the Restated Consolidated Financial Information, and (b) report dated September 6, 2023, on the statement of special tax benefits; and such consent has not been withdrawn as on the date of this DRHP. However, the term “expert” and “consent” shall not be construed to mean an “expert” and “consent” as defined under the U.S. Securities Act.
- (20) The examination report dated August 30, 2023, of our Statutory Auditor on the Restated Consolidated Financial Information, included in this Red Herring Prospectus.
- (21) The statement of special tax benefits dated September 6, from our Statutory Auditors.
- (22) Consents of our Directors, our Company Secretary and Compliance Officer, legal advisors to the Offer, Bankers to our Company, Banker(s) to the Offer, the BRLMs, Syndicate Members, lenders to the Company, and the Registrar to the Offer, Monitoring Agency, to act in their respective capacities.
- (23) Consent dated August 28, 2023, from Vishvakarma Consultancy Services Private Limited, Chartered Engineer, to include their name as required under Section 26(5) of the Companies Act read with SEBI ICDR Regulations, in this Red Herring Prospectus and as an “expert”, as defined under Section 2(38) of the Companies Act, 2013 to the extent and in their capacity as an Independent Chartered Engineer, in relation to the certificate dated August 28, 2023, certifying, *inter alia*, the details of the installed and production capacity of our manufacturing facilities.
- (24) Certificate dated September 6, 2023, from our Independent Chartered Accountant with respect to our key performance indicators.
- (25) Consent letter dated August 30, 2023, from Technopak Advisors Private Limited with respect to the Technopak Report.
- (26) Industry Report titled “*Consumer Electrical Industry in India*” dated August 30, 2023, prepared and issued by Technopak Advisors Private Limited and commissioned and paid for by the Company, exclusively for the purpose of this Offer.
- (27) Guarantees as set out under “*History and Certain Corporate Matters - Details of guarantees given to third parties by our Promoters who are participating in the Offer for Sale*” on page 241.
- (28) R R Kabel Employee Stock Option Plan 2020.
- (29) R R Kabel Employee Stock Option Plan 2023.
- (30) Copies of annual reports of our Company for the preceding three Fiscals i.e. Fiscals 2023, 2022 and 2021.
- (31) Due diligence certificate dated May 5, 2023, addressed to SEBI from the BRLMs.
- (32) Tripartite agreement dated April 27, 2023, amongst our Company, CDSL and Link Intime India Private Limited.

- (33) Tripartite agreement dated April 28, 2023, between our Company, NSDL and Link Intime India Private Limited.
- (34) In-principle listing approvals each dated June 9, 2023, issued by BSE and NSE.
- (35) SEBI final observation letter bearing reference number SEBI/HO/CFD/RAC/DIL-1/EB/SM/OW/2023/34465/1 dated August 24, 2023.

Any of the contracts or documents mentioned in this Red Herring Prospectus may be amended or modified at any time if so required in the interest of our Company or if required by the other parties, without notice to the Shareholders subject to compliance with the provisions contained in the Companies Act and other applicable law.

DECLARATION

I hereby certify and declare that all relevant provisions of the Companies Act and the guidelines, rules and regulations issued by the Government of India or the guidelines, rules, or regulations issued by SEBI, established under Section 3 of the SEBI Act, as the case may be, have been complied with, and no statements, disclosures and undertakings made in this Red Herring Prospectus is contrary to the provisions of the Companies Act, the SCRA, the SCRR, the SEBI Act or the rules, guidelines or regulations issued thereunder, as the case may be. I further certify that all the statements, disclosures and undertakings made in this Red Herring Prospectus are true and correct.

SIGNED BY THE DIRECTOR OF OUR COMPANY

Tribhuvanprasad Rameshwarlal Kabra

Executive Chairman

Date: September 6, 2023

Place: Vadodara

DECLARATION

I hereby certify and declare that all relevant provisions of the Companies Act and the guidelines, rules and regulations issued by the Government of India or the guidelines, rules, or regulations issued by SEBI, established under Section 3 of the SEBI Act, as the case may be, have been complied with, and no statements, disclosures and undertakings made in this Red Herring Prospectus is contrary to the provisions of the Companies Act, the SCRA, the SCRR, the SEBI Act or the rules, guidelines or regulations issued thereunder, as the case may be. I further certify that all the statements, disclosures and undertakings made in this Red Herring Prospectus are true and correct.

SIGNED BY THE DIRECTOR OF OUR COMPANY

Shreegopal Rameshwarlal Kabra

Managing Director

Date: September 6, 2023

Place: Mumbai

DECLARATION

I hereby certify and declare that all relevant provisions of the Companies Act and the guidelines, rules and regulations issued by the Government of India or the guidelines, rules, or regulations issued by SEBI, established under Section 3 of the SEBI Act, as the case may be, have been complied with, and no statements, disclosures and undertakings made in this Red Herring Prospectus is contrary to the provisions of the Companies Act, the SCRA, the SCRR, the SEBI Act or the rules, guidelines or regulations issued thereunder, as the case may be. I further certify that all the statements, disclosures and undertakings made in this Red Herring Prospectus are true and correct.

SIGNED BY THE DIRECTOR OF OUR COMPANY

Mahendrakumar Rameshwarlal Kabra

Joint Managing Director

Date: September 6, 2023

Place: Mumbai

DECLARATION

I hereby certify and declare that all relevant provisions of the Companies Act and the guidelines, rules and regulations issued by the Government of India or the guidelines, rules, or regulations issued by SEBI, established under Section 3 of the SEBI Act, as the case may be, have been complied with, and no statements, disclosures and undertakings made in this Red Herring Prospectus is contrary to the provisions of the Companies Act, the SCRA, the SCRR, the SEBI Act or the rules, guidelines or regulations issued thereunder, as the case may be. I further certify that all the statements, disclosures and undertakings made in this Red Herring Prospectus are true and correct.

SIGNED BY THE DIRECTOR OF OUR COMPANY

Mitesh Daga

Non-Executive Nominee Director

Date: September 6, 2023

Place: Mumbai

DECLARATION

I hereby certify and declare that all relevant provisions of the Companies Act and the guidelines, rules and regulations issued by the Government of India or the guidelines, rules, or regulations issued by SEBI, established under Section 3 of the SEBI Act, as the case may be, have been complied with, and no statements, disclosures and undertakings made in this Red Herring Prospectus is contrary to the provisions of the Companies Act, the SCRA, the SCRR, the SEBI Act or the rules, guidelines or regulations issued thereunder, as the case may be. I further certify that all the statements, disclosures and undertakings made in this Red Herring Prospectus are true and correct.

SIGNED BY THE DIRECTOR OF OUR COMPANY

Bhagwat Singh Babel

Independent Director

Date: September 6, 2023

Place: Udaipur

DECLARATION

I hereby certify and declare that all relevant provisions of the Companies Act and the guidelines, rules and regulations issued by the Government of India or the guidelines, rules, or regulations issued by SEBI, established under Section 3 of the SEBI Act, as the case may be, have been complied with, and no statements, disclosures and undertakings made in this Red Herring Prospectus is contrary to the provisions of the Companies Act, the SCRA, the SCRR, the SEBI Act or the rules, guidelines or regulations issued thereunder, as the case may be. I further certify that all the statements, disclosures and undertakings made in this Red Herring Prospectus are true and correct.

SIGNED BY THE DIRECTOR OF OUR COMPANY

Ramesh Chandak

Independent Director

Date: September 6, 2023

Place: Mumbai

DECLARATION

I hereby certify and declare that all relevant provisions of the Companies Act and the guidelines, rules and regulations issued by the Government of India or the guidelines, rules, or regulations issued by SEBI, established under Section 3 of the SEBI Act, as the case may be, have been complied with, and no statements, disclosures and undertakings made in this Red Herring Prospectus is contrary to the provisions of the Companies Act, the SCRA, the SCRR, the SEBI Act or the rules, guidelines or regulations issued thereunder, as the case may be. I further certify that all the statements, disclosures and undertakings made in this Red Herring Prospectus are true and correct.

SIGNED BY THE DIRECTOR OF OUR COMPANY

Vipul Sabharwal

Independent Director

Date: September 6, 2023

Place: Gurugram

DECLARATION

I hereby certify and declare that all relevant provisions of the Companies Act and the guidelines, rules and regulations issued by the Government of India or the guidelines, rules, or regulations issued by SEBI, established under Section 3 of the SEBI Act, as the case may be, have been complied with, and no statements, disclosures and undertakings made in this Red Herring Prospectus is contrary to the provisions of the Companies Act, the SCRA, the SCRR, the SEBI Act or the rules, guidelines or regulations issued thereunder, as the case may be. I further certify that all the statements, disclosures and undertakings made in this Red Herring Prospectus are true and correct.

SIGNED BY THE DIRECTOR OF OUR COMPANY

Jyoti Davar

Independent Director

Date: September 6, 2023

Place: New Delhi

DECLARATION

I hereby certify and declare that all relevant provisions of the Companies Act and the guidelines, rules and regulations issued by the Government of India or the guidelines, rules, or regulations issued by SEBI, established under Section 3 of the SEBI Act, as the case may be, have been complied with, and no statements, disclosures and undertakings made in this Red Herring Prospectus is contrary to the provisions of the Companies Act, the SCRA, the SCRR, the SEBI Act or the rules, guidelines or regulations issued thereunder, as the case may be. I further certify that all the statements, disclosures and undertakings made in this Red Herring Prospectus are true and correct.

SIGNED BY THE CHIEF FINANCIAL OFFICER OF OUR COMPANY

Rajesh Babu Jain

Chief Financial Officer

Date: September 6, 2023

Place: Mumbai

DECLARATION

I, Mahendrakumar Rameshwarlal Kabra, acting as a Selling Shareholder hereby confirm that all statements, disclosures and undertakings specifically made or confirmed by me in this Red Herring Prospectus about or in relation to myself, as a Selling Shareholder and my portion of the Offered Shares, are true and correct. I assume no responsibility, as a Selling Shareholder, for any other statements, disclosures and undertakings including statements, disclosures or undertakings made or confirmed by or relating to the Company or any other Selling Shareholder(s) or any other person(s) in this Red Herring Prospectus.

Mahendrakumar Rameshwarlal Kabra

Place: Mumbai

Date: September 6, 2023

DECLARATION

I, Hemant Mahendrakumar Kabra, acting as a Selling Shareholder hereby confirm that all statements, disclosures and undertakings specifically made or confirmed by me in this Red Herring Prospectus about or in relation to myself, as a Selling Shareholder and my portion of the Offered Shares, are true and correct. I assume no responsibility, as a Selling Shareholder, for any other statements, disclosures and undertakings including statements, disclosures or undertakings made or confirmed by or relating to the Company or any other Selling Shareholder(s) or any other person(s) in this Red Herring Prospectus.

Hemant Mahendrakumar Kabra

Place: Singapore

Date: September 6, 2023

DECLARATION

I, Sumeet Mahendrakumar Kabra, acting as a Selling Shareholder hereby confirm that all statements, disclosures and undertakings specifically made or confirmed by me in this Red Herring Prospectus about or in relation to myself, as a Selling Shareholder and my portion of the Offered Shares, are true and correct. I assume no responsibility, as a Selling Shareholder, for any other statements, disclosures and undertakings including statements, disclosures or undertakings made or confirmed by or relating to the Company or any other Selling Shareholder(s) or any other person(s) in this Red Herring Prospectus.

Sumeet Mahendrakumar Kabra

Place: Mumbai

Date: September 6, 2023

DECLARATION

We, Kabel Buildcon Solutions Private Limited, acting as a Selling Shareholder hereby confirm and declare that all statements, disclosures and undertakings made or confirmed by us in this Red Herring Prospectus in relation to ourselves, as one of the Selling Shareholder and our portion of the Offered Shares, are true and correct. We assume no responsibility as a Selling Shareholder, for any other statements, disclosures and undertakings including any of the statements, disclosures and undertakings made or confirmed by or relating to the Company or any other Selling Shareholder(s) or any other person(s) in this Red Herring Prospectus.

FOR AND ON BEHALF OF KABEL BUILDCON SOLUTIONS PRIVATE LIMITED

Name: Tribhuvanprasad Kabra

Designation: Director

Place: Vadodara

Date: September 6, 2023

DECLARATION

We, Ram Ratna Wires Limited, acting as a Selling Shareholder hereby confirm and declare that all statements, disclosures and undertakings made or confirmed by us in this Red Herring Prospectus in relation to ourselves, as one of the Selling Shareholder and our portion of the Offered Shares, are true and correct. We assume no responsibility as a Selling Shareholder, for any other statements, disclosures and undertakings including any of the statements, disclosures and undertakings made or confirmed by or relating to the Company or any other Selling Shareholder(s) or any other person(s) in this Red Herring Prospectus.

FOR AND ON BEHALF OF RAM RATNA WIRES LIMITED

Name: Mahendrakumar Kabra

Designation: Managing Director

Place: Mumbai

Date: September 6, 2023

DECLARATION

We, TPG Asia VII SF Pte. Ltd., acting as a Selling Shareholder hereby confirm and declare that all statements, disclosures and undertakings made or confirmed by us in this Red Herring Prospectus in relation to ourselves, as one of the Selling Shareholder and our portion of the Offered Shares, are true and correct. We assume no responsibility as a Selling Shareholder, for any other statements, disclosures and undertakings including any of the statements, disclosures and undertakings made or confirmed by or relating to the Company or any other Selling Shareholder(s) or any other person(s) in this Red Herring Prospectus.

FOR AND ON BEHALF OF TPG ASIA VII SF PTE. LTD.

Name: David Tan

Designation: Director

Place: Singapore

Date: September 6, 2023